

Where Is the Block?

**Directions:**

1. Cut out the cards.
2. Place the cards in a stack face down.
3. Partner A chooses a card from the stack (while not showing it to partner B) and provides direction using that card, e.g., "Put the block under the desk."
4. Partner B moves the object.
5. Partner A reveals the card and Partner B corrects position if needed.
6. Trade roles and continue playing until all cards have been used.

Under

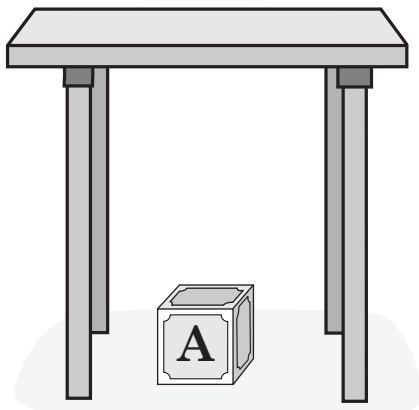

Next to

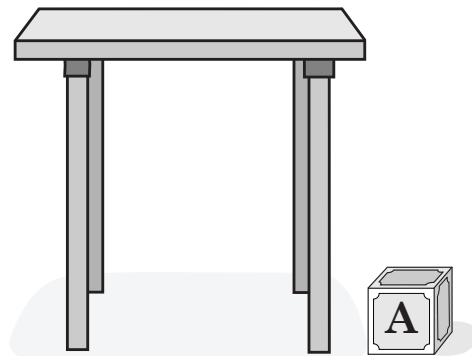

Top

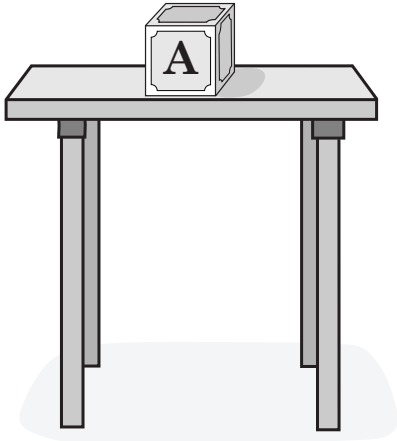

Bottom

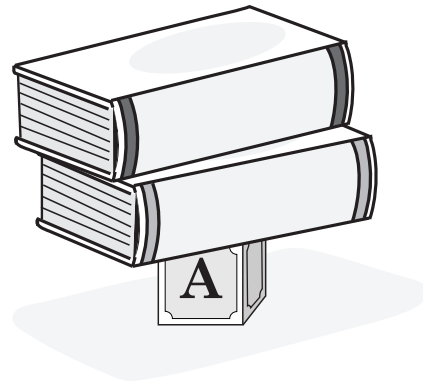

On

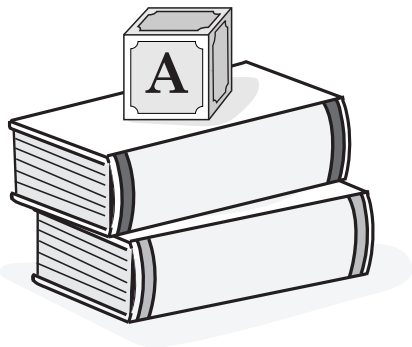

Behind

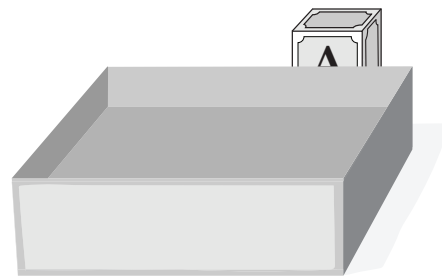

In front

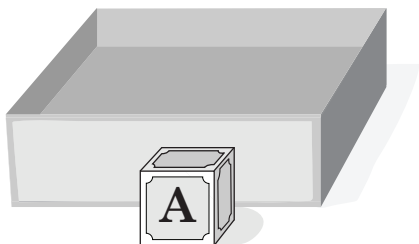

Inside

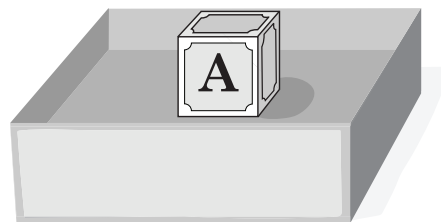

Below

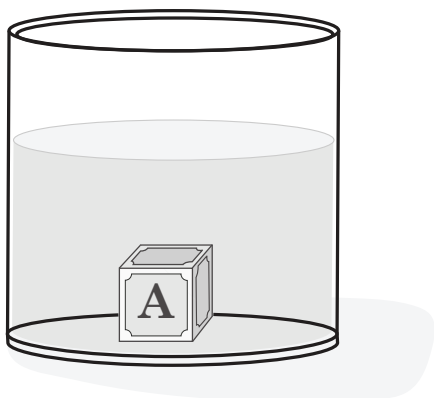

Above

