

VOCABULARY CARDS

EL SUPPORT LESSON PLAN: THE LANGUAGE OF ESTIMATION

about

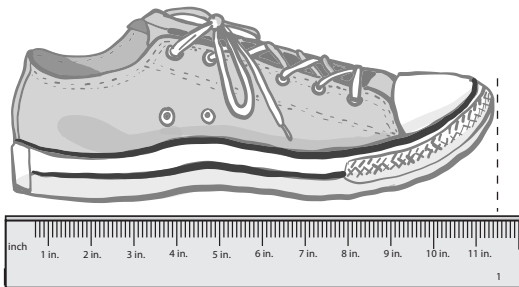

almost or nearly

close

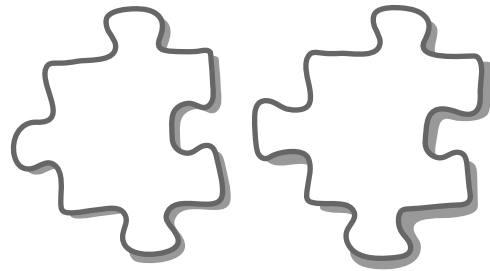

very similar, almost the same

estimate



using information you already have to decide about the size or amount of something

less

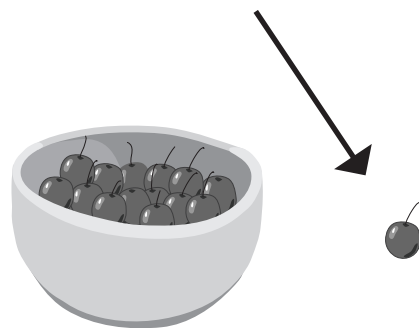

smaller in amount or number



VOCABULARY CARDS

EL SUPPORT LESSON PLAN: THE LANGUAGE OF ESTIMATION

measure

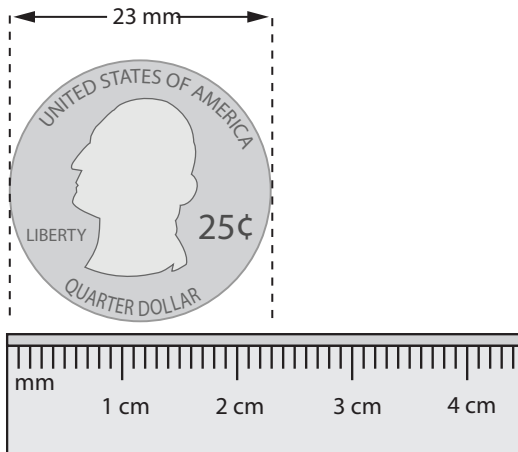

to find out the size, length,
or amount of something

more

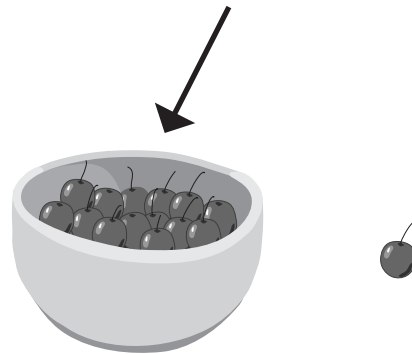

greater in amount,
number, or size

length

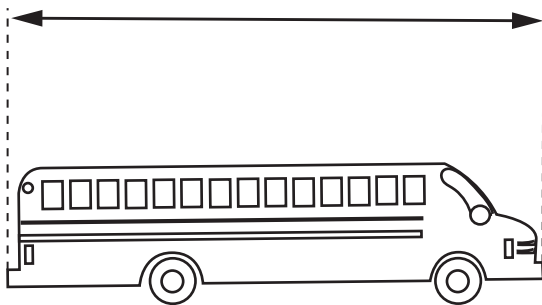

the measurement of
something from
end to end

foot

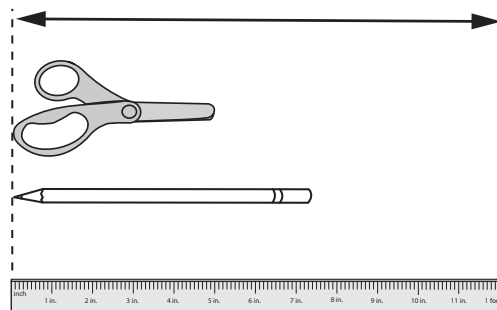

a unit of measurement
equal to 12 inches

