

VOCABULARY CARDS

EL SUPPORT LESSON PLAN: 3-D SCAVENGER HUNT!

cone

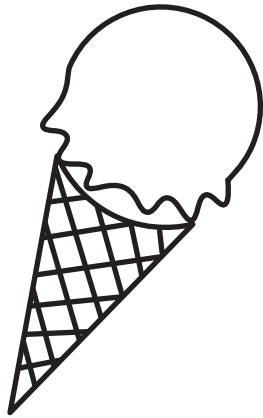

a shape that has a pointed top and sides that form a circle at the bottom

cube

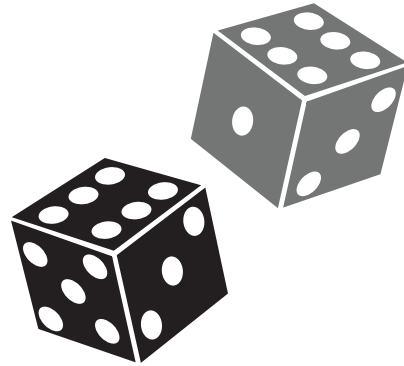

a shape that has six square sides

attribute

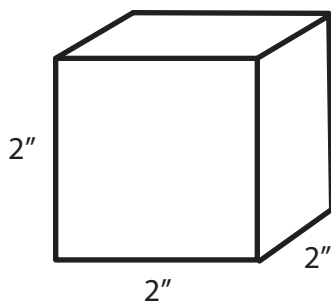

a characteristic or property of an object such as color, shape, size, etc.

rectangular prism

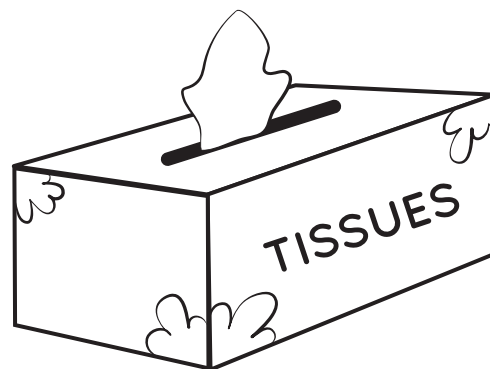

a 3-dimensional object which has six faces that are rectangles



VOCABULARY CARDS

EL SUPPORT LESSON PLAN: 3-D SCAVENGER HUNT!

**square-based
pyramid**

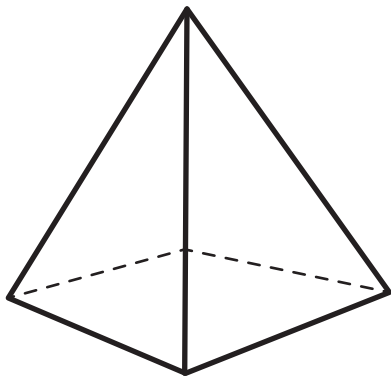

a pyramid that has
a square base

face

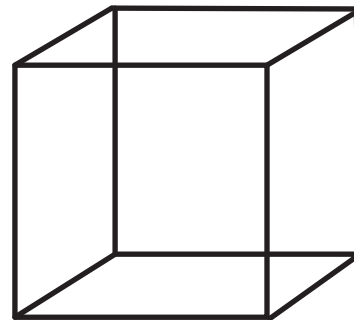

6 faces

a flat or curved surface

vertex

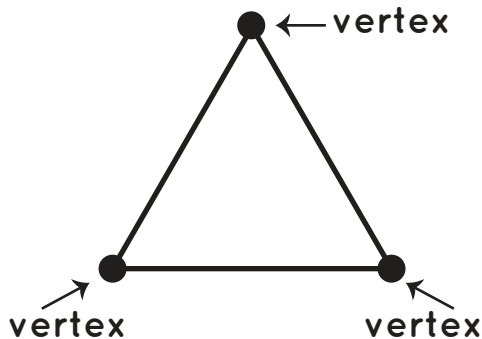

a point where two or more
curves, lines, or edges meet

edge

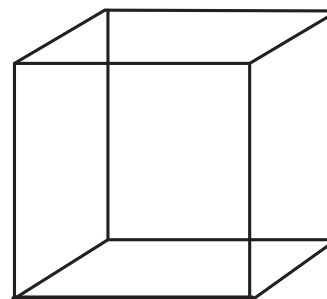

edge

a straight or curved line that
is the intersection of two
faces of a solid figure

