

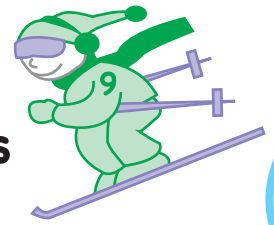

# Ski Race #8

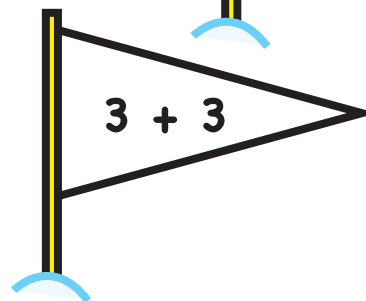

Which skier will round the most flags to win the race? Find out by coloring the flags that equal 6 **red** and the flags that equal 9 **green**. READY! SET! GO!

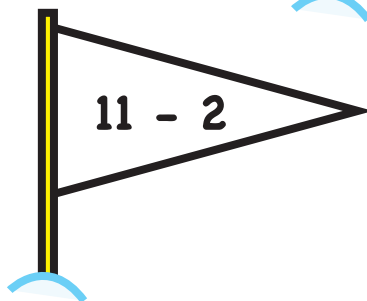
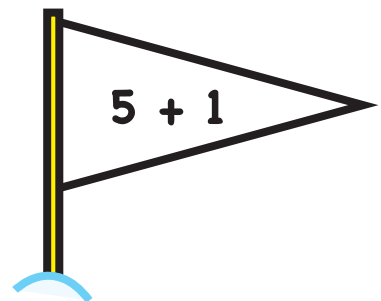
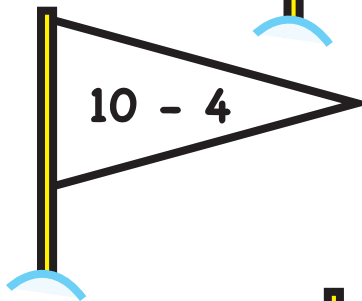
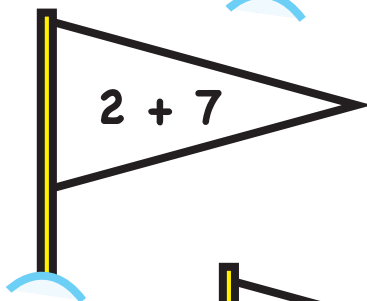
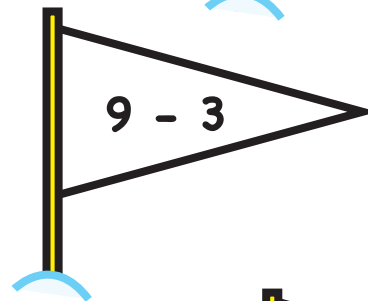
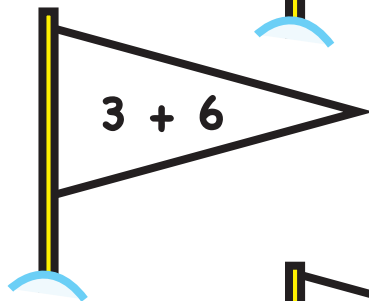
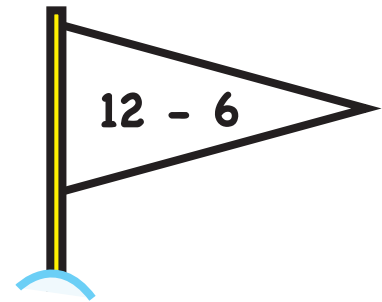
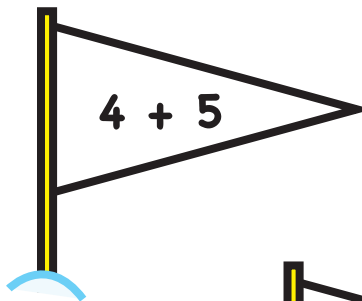
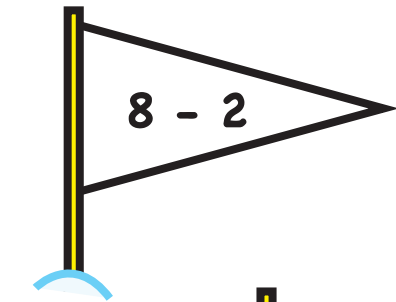

FINISH

The race is over! Let's see who won!  
Which skier rounded the most flags? Circle your answer.

The Red Skier

The Green Skier

It's a tie!