

Color and create your own

Happy Holidays!

BANNER

1

Color. With an adult's supervision, cut along the dotted lines. Fold.

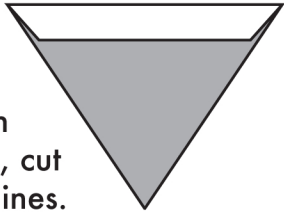

2

Tape the fold down. Run a string through the slot.

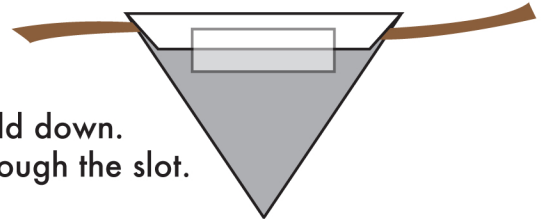

3

Chain the letters and pictures together. Your banner is ready to hang!

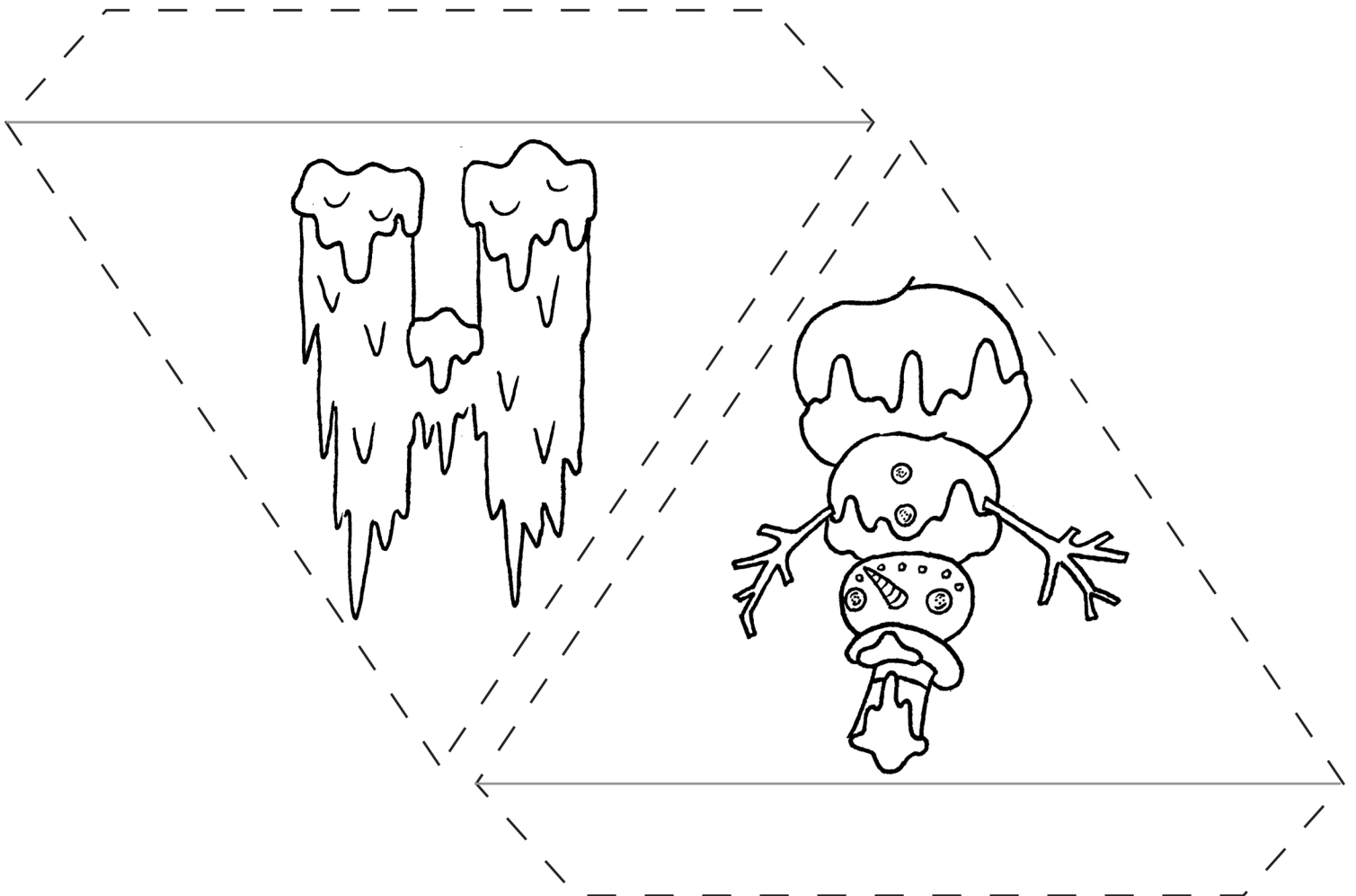
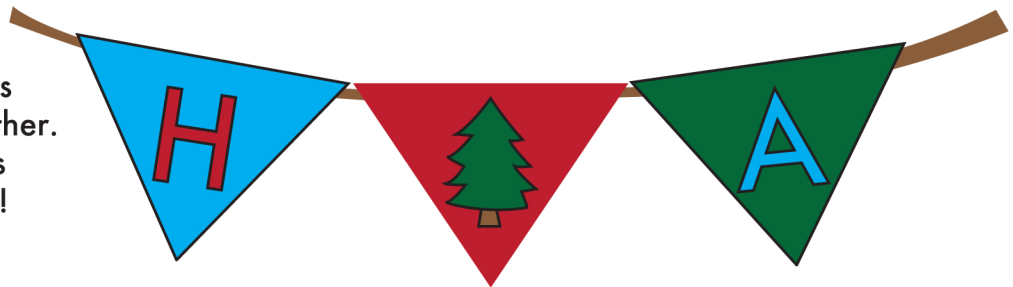

Color and create your own

Happy Holidays!

BANNER

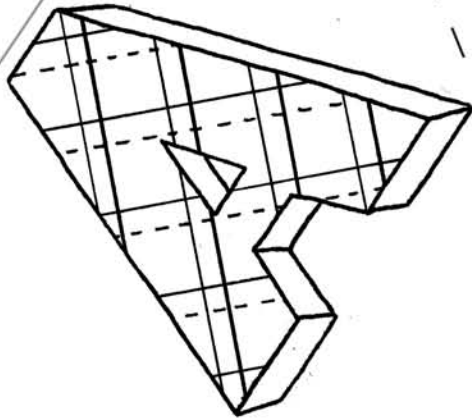

Color and create your own

Happy Holidays!

BANNER

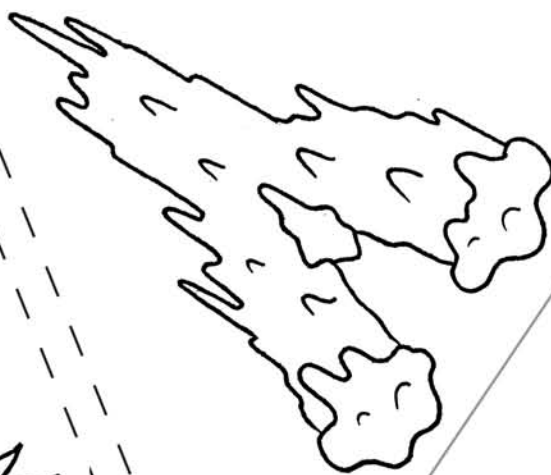
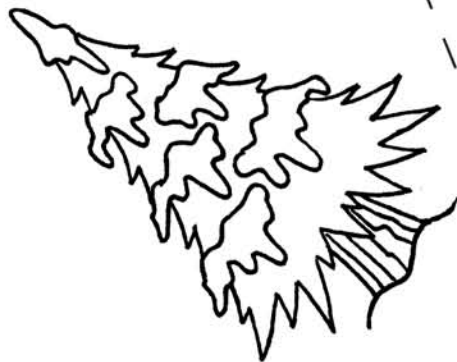
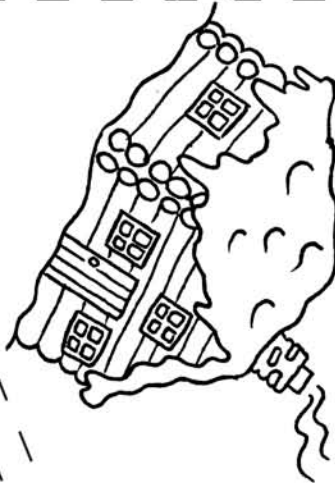
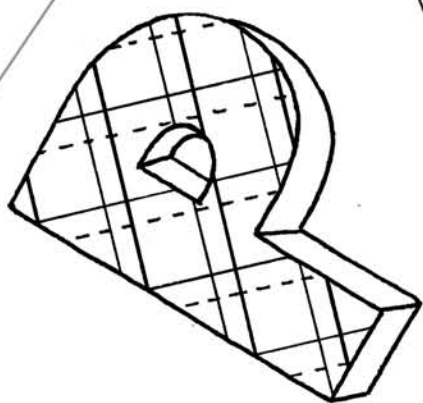

Color and create your own

Happy Holidays!

BANNER

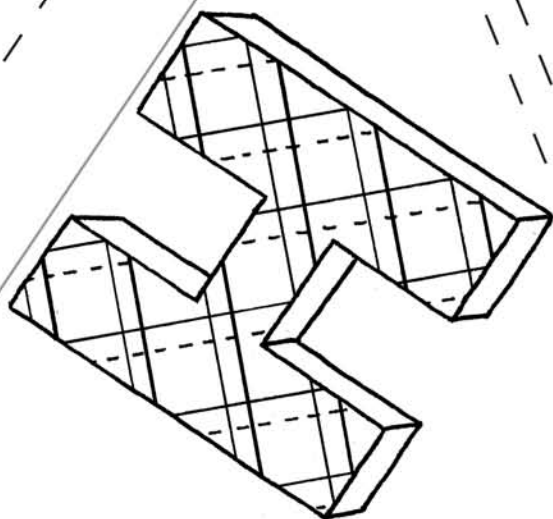

Color and create your own

Happy Holidays!

BANNER

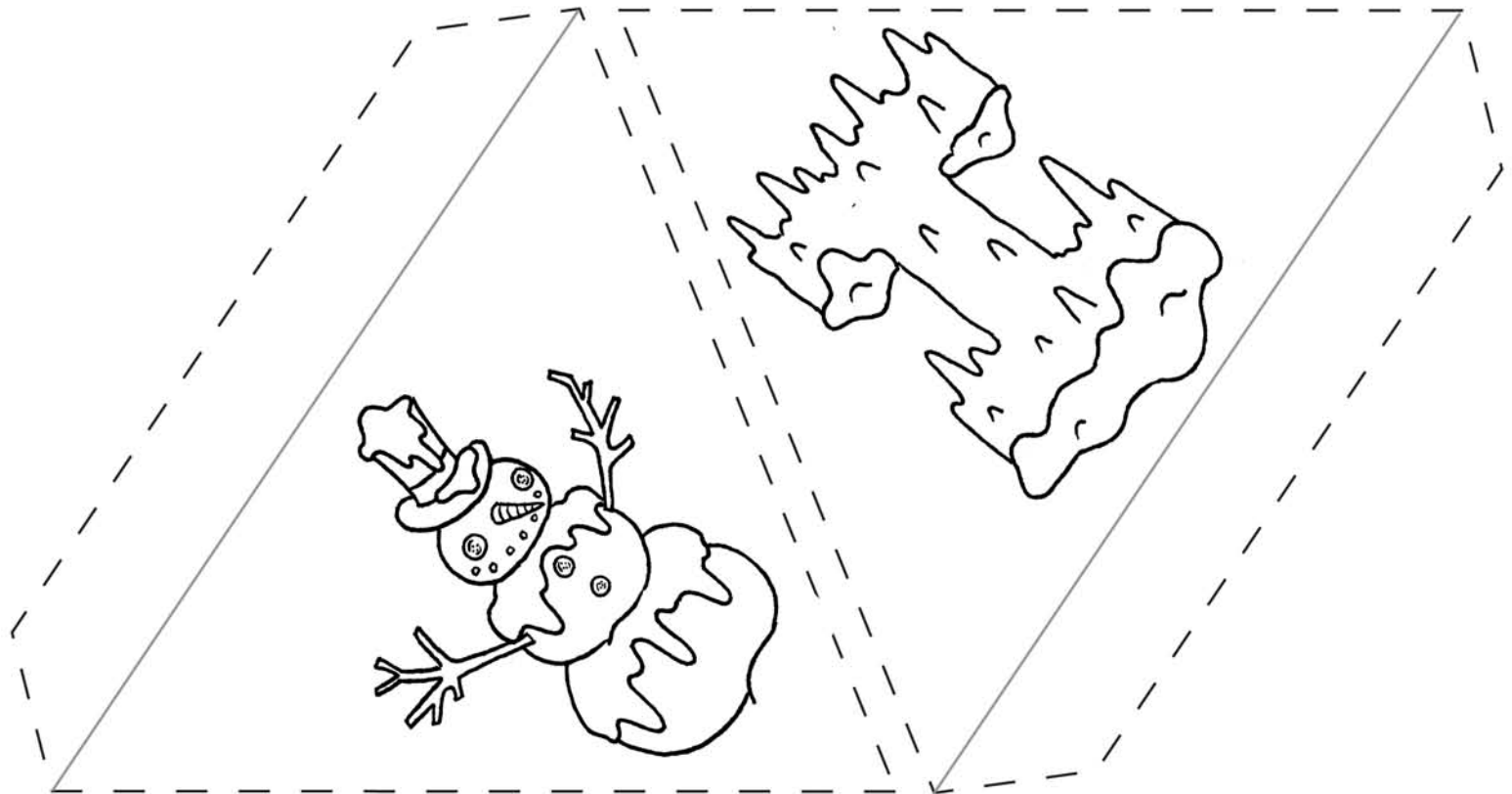
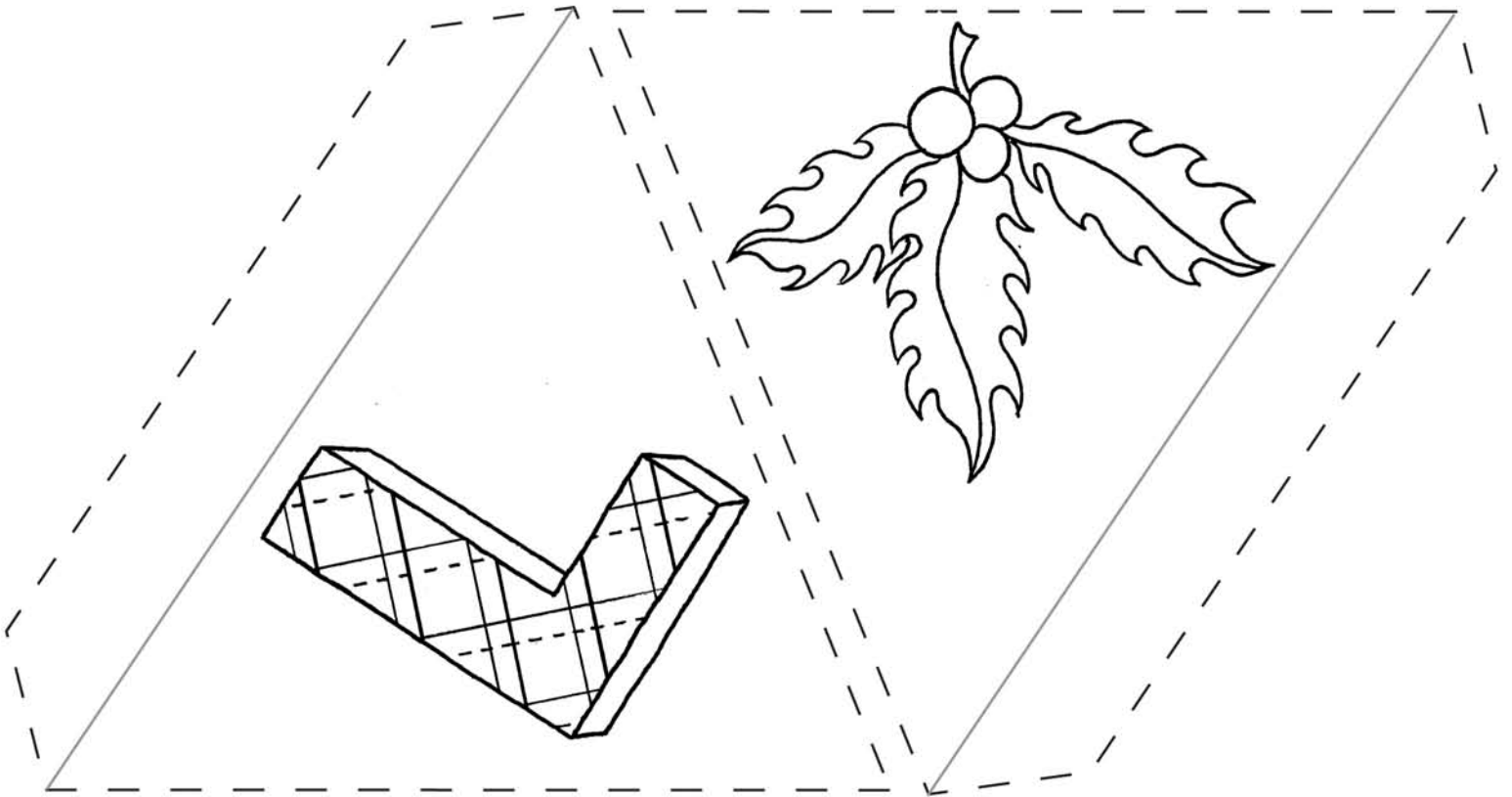

Color and create your own

Happy Holidays!

BANNER

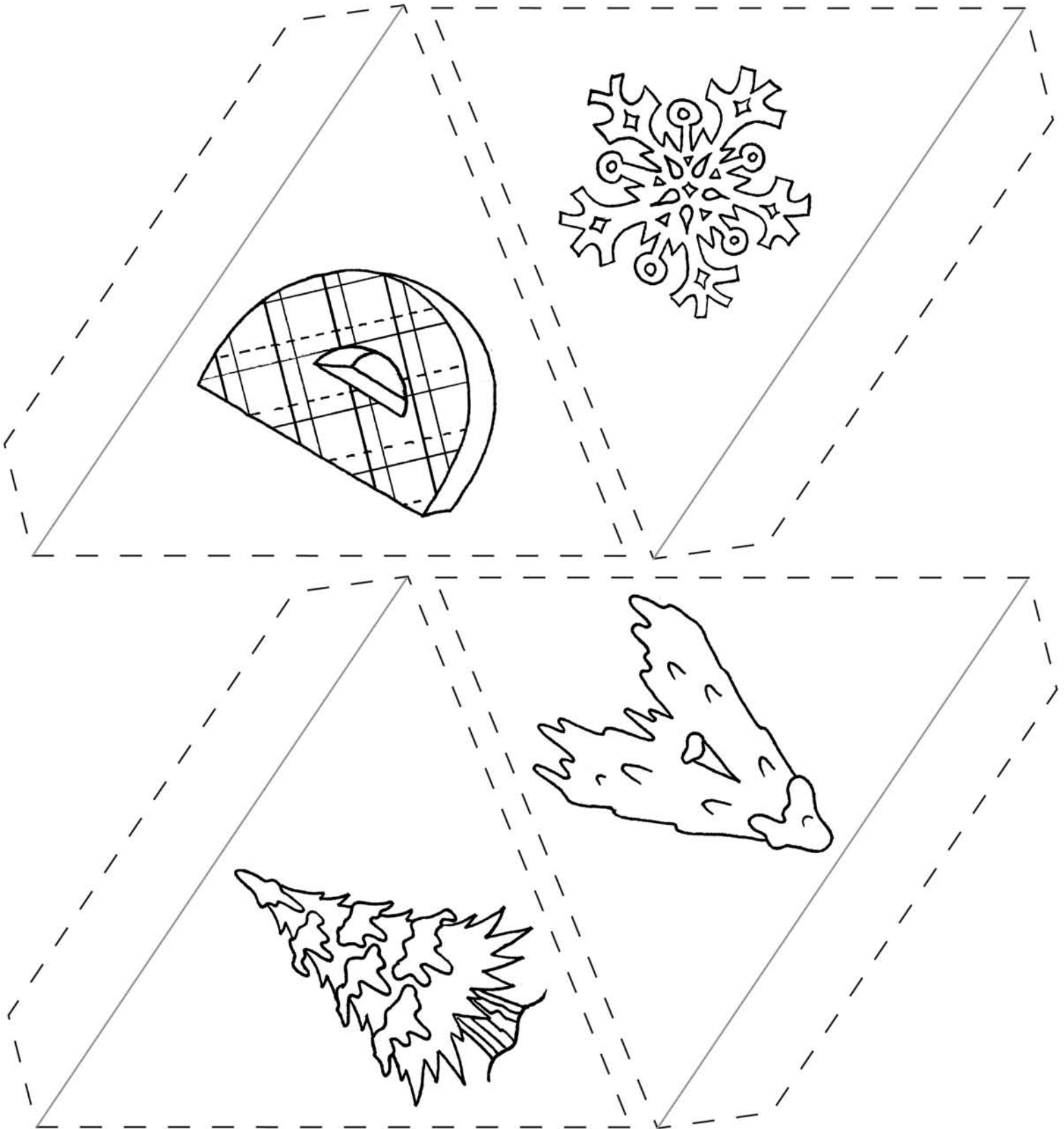

Color and create your own

Happy Holidays!

BANNER

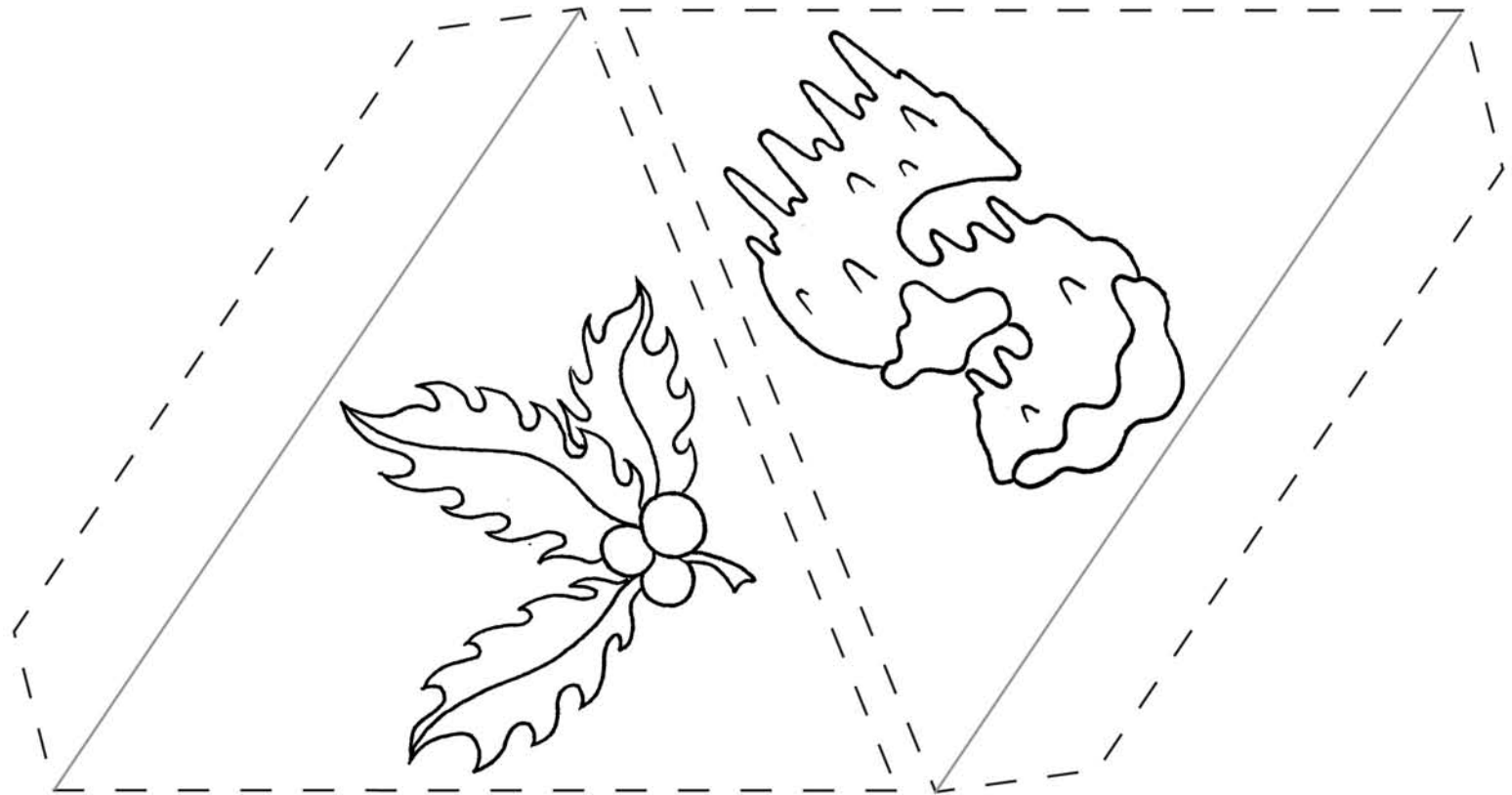
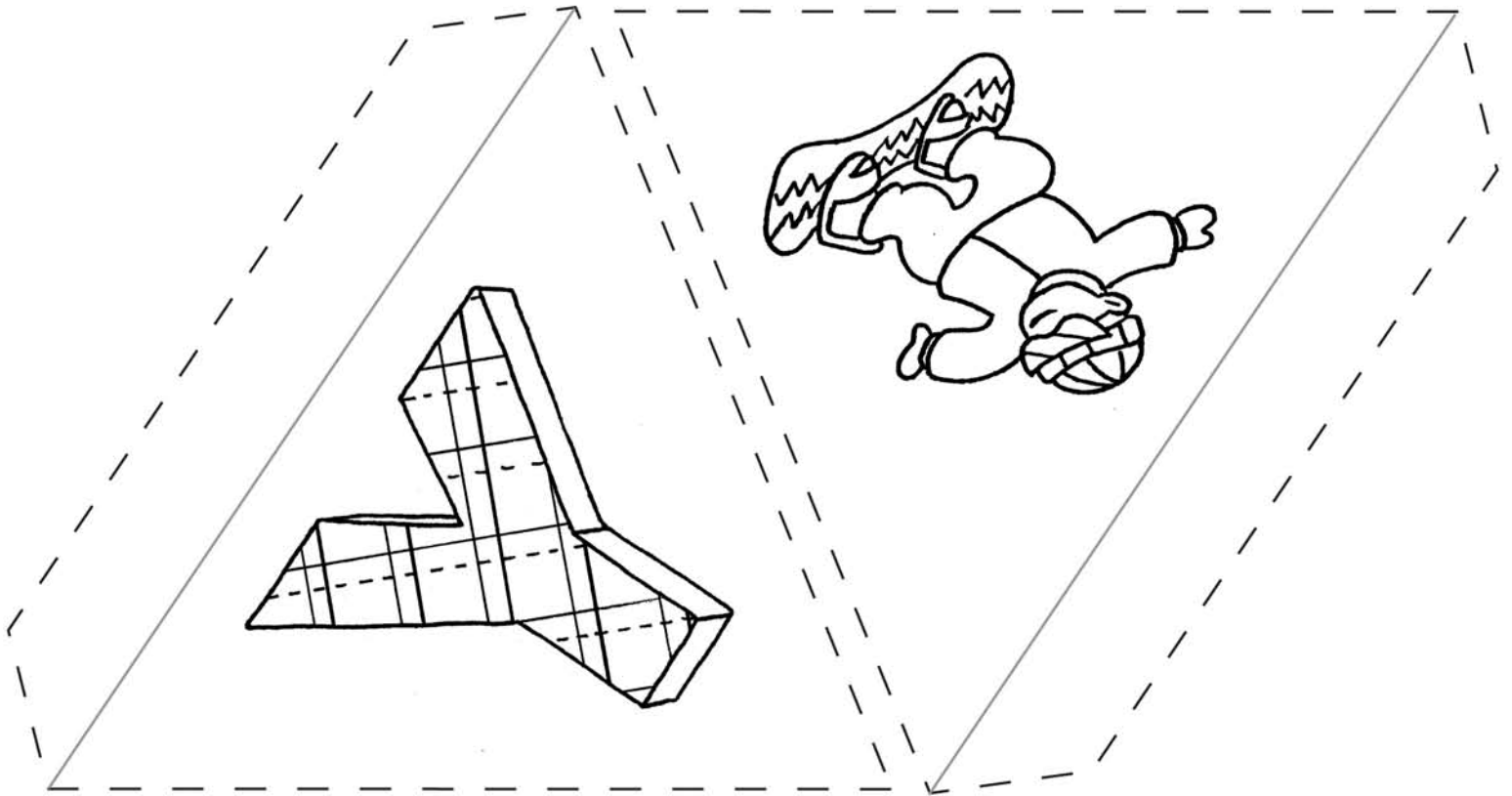

Color and create your own

Happy Holidays!

BANNER

