

Name _____ Date _____

Calculating Surface Area #4

Find the surface area of each shape.

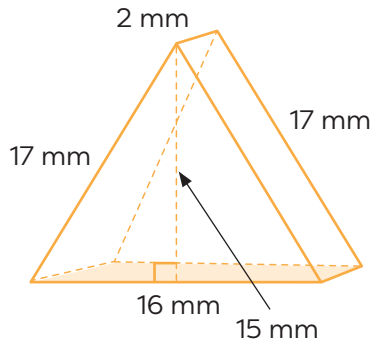

Surface area = _____

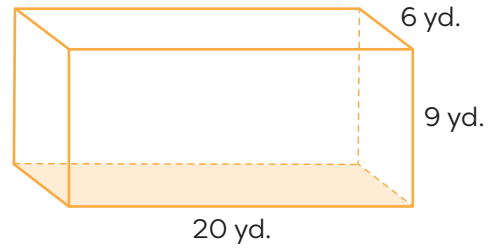

Surface area = _____

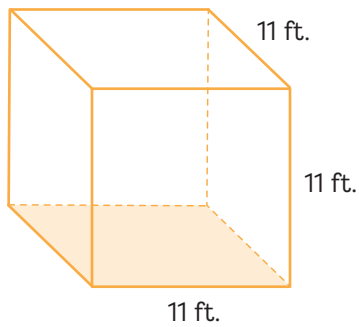

Surface area = _____

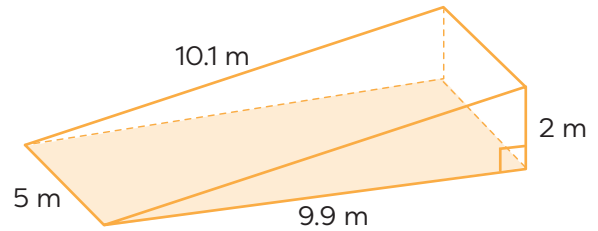

Surface area = _____

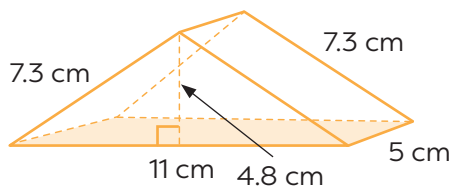

Surface area = _____

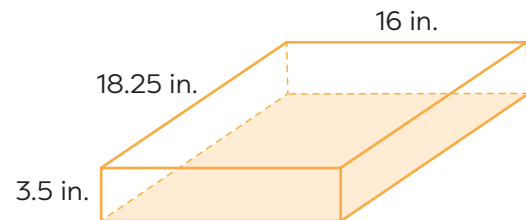

Surface area = _____