

# JUST PLANE BUSY

K  
Kindergarten



# Table of Contents

---

## Just Plane Busy

- Plane Busy Book Introduction
  - What Did You Pack?
- Complete This Airport Scene
  - Parts of a Plane
  - Are You On Board?
  - Look Out a Window
  - Ready for Takeoff!
- Complete the Word #1
- Where Are They Headed?
  - What's Different?
  - How Many?
- Funny Clown Color by Number
  - Trip Fun Words
  - Make an Airplane Buddy!
  - Shapes on a Plane
  - Check out the View
- Complete the Word #2
- Landscape Coloring
- What's Below the Surface
  - Vacation Key Words
- I Spy with My Little Eye...
  - Color by Number
- Bird's Eye View Coloring Page
  - Exit the Plane
  - Airport Maze
- Vacation Sight Words
- Vacation Picture

*Certificate of Completion*

# GET READY FOR TAKEOFF!



What You'll Need:  
A Pencil  
Coloring Materials

While soaring through the air your kid will cover many of the important academic basics while staying busy. The book begins with an introduction to the different parts of a plane by way of a **tracing** and **labeling** activity. **Number identification** and **sequencing** are touched on, and all the **coloring** opportunities will provide a nice mental break. Watch as your traveler not only interacts with the immediate surroundings in the cabin, but also takes advantage of the bird's eye view.

What's more, **fine motor skills** will get a workout thanks to imagination-inspiring **drawing** activities, **dot-to-dots** and **mazes**. Many of the other exercises featured in the busy book will strengthen awareness of **letter-sound correspondence**. Your child will benefit from the inclusion of both familiar **sight words** as well as plenty of **brand new words** that will add to newly forming **reading skills**. After learning a whole bunch of travel vocabulary words, your kid will definitely be ready to talk about your trip.

# What did you pack?

Color the pictures and circle what you packed for your trip.



# Complete this Airport Scene

Trace the dotted lines to bring the airport to life. Once you're done, color in the airport scene.

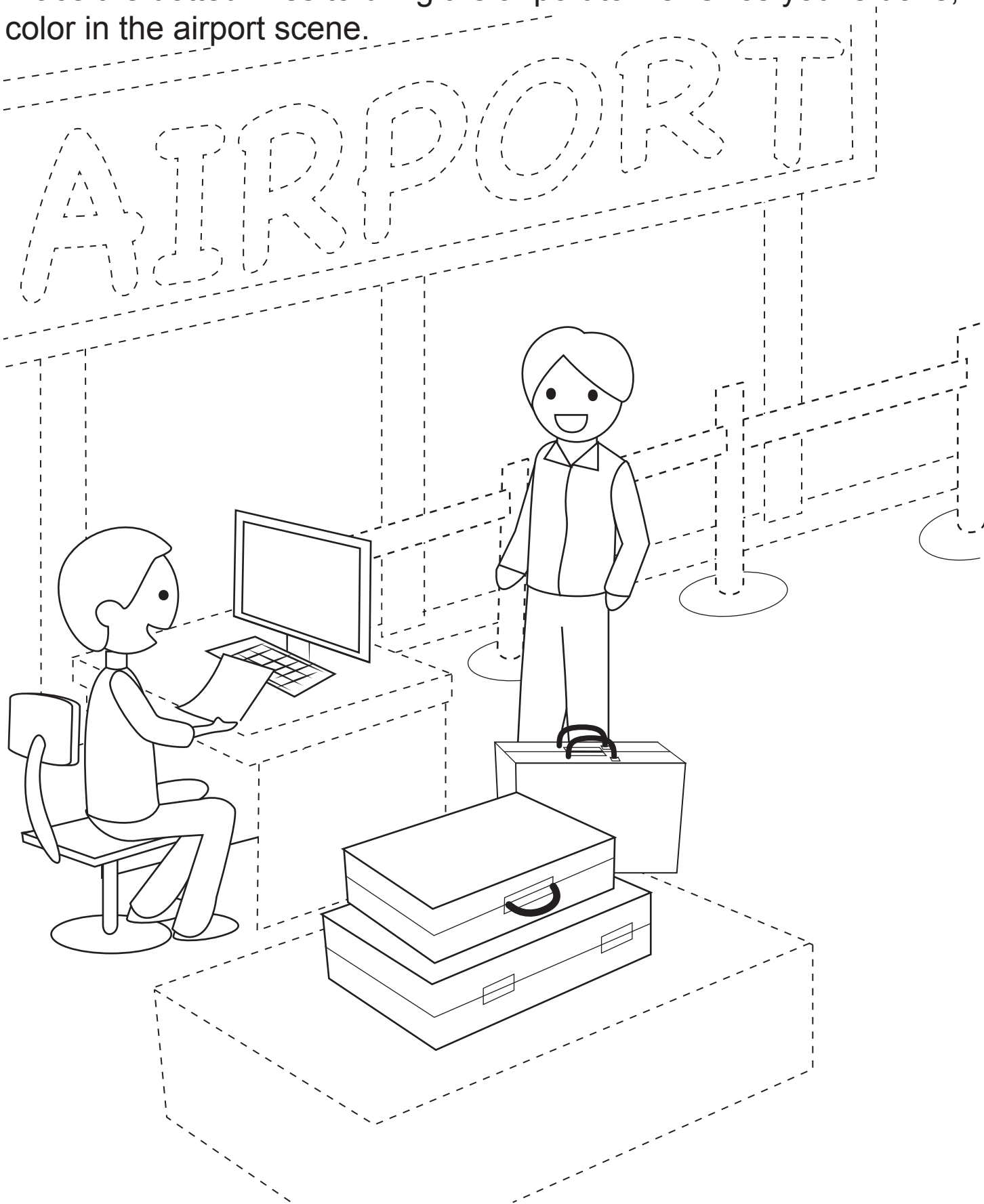

# Parts of a Plane: Identify and Label

Trace the words to label the different parts of the plane. When you're finished, give your plane a little color.

wing

elevator

rudder

flap

spoiler

cockpit

slats

turbine engine

# Parts of a Plane



The parts of the plane all work in different ways. Check out these parts that help the plane take off, fly, and land. Read aloud to your child to explain important parts of the plane, and sound out any of the words that are new or difficult for him.

**cockpit-** place at the front of the plane where the pilot sits and controls how the plane flies



**wings-** produce lift so the plane can get up into the sky

**rudder-** helps control movement of the plane to the right and left, or yaw, and keeps the plane stable and under control



**elevator-** helps control the up and down movement of the plane, or pitch, and keeps the plane stable

**slat-** moving piece on the front part of the wing that helps helps the pilot land the plane

**flap-** moving piece on the back part of the wing that helps the plane take off by increasing lift



**spoiler-** helps the plane descend so the pilot can land the plane

**turbine engines-** generate thrust to push the plane through the air



# Parts of a Plane

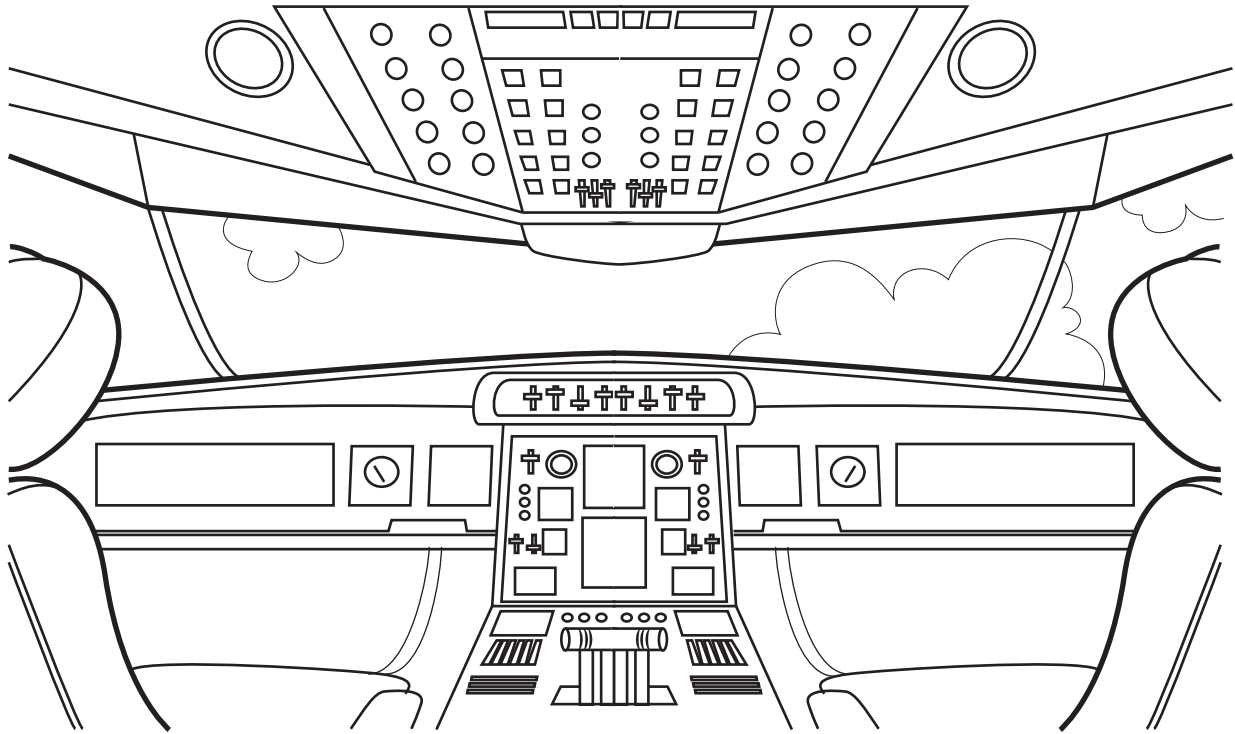
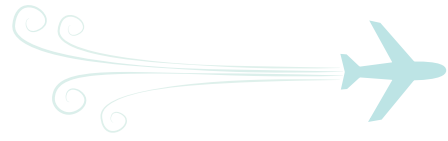

COCKPIT

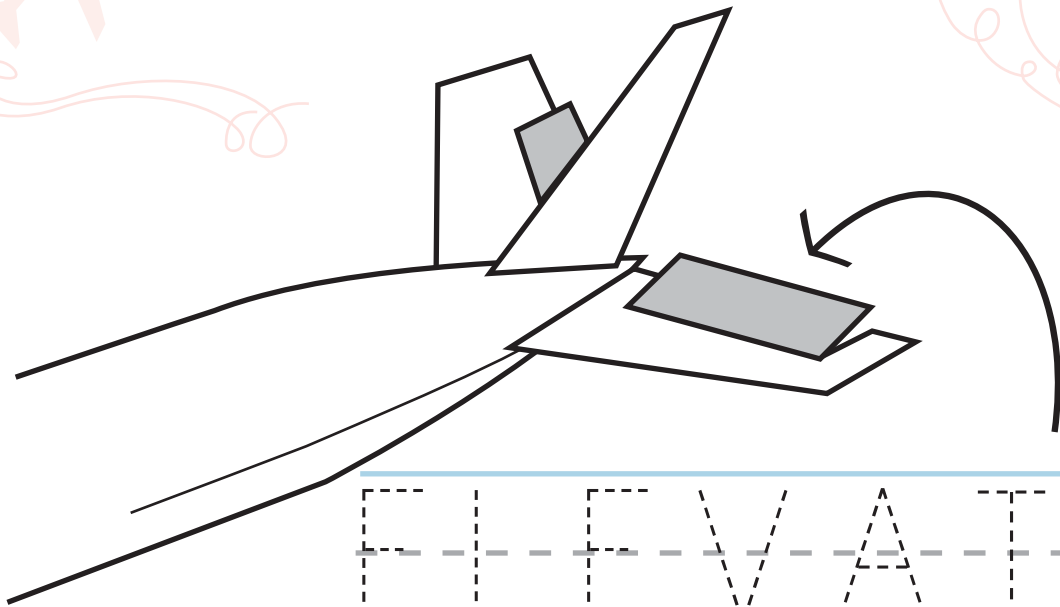

ELEVATOR



# Parts of a Plane

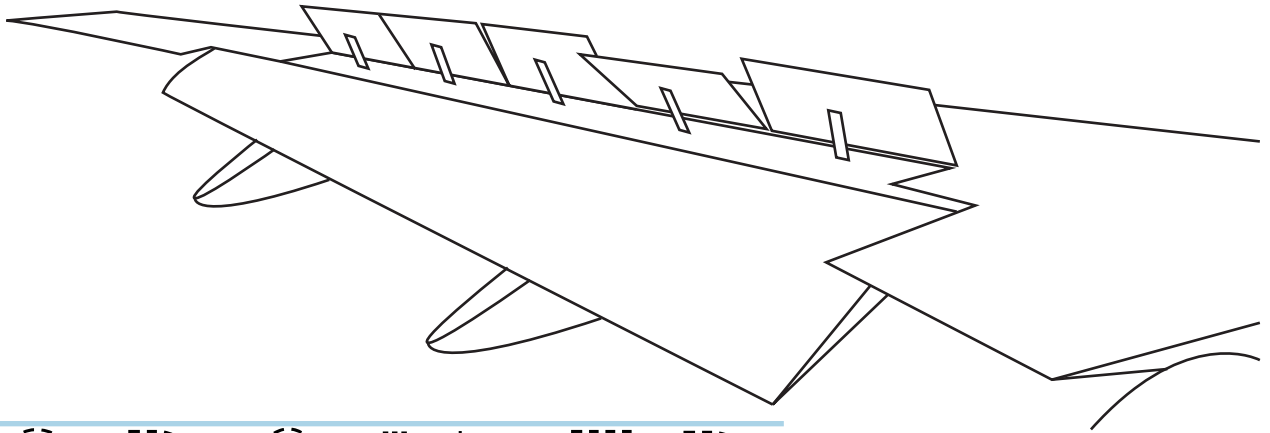
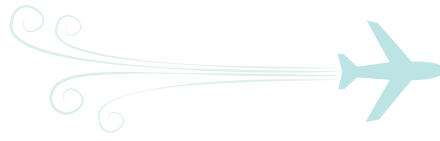

SPOILER

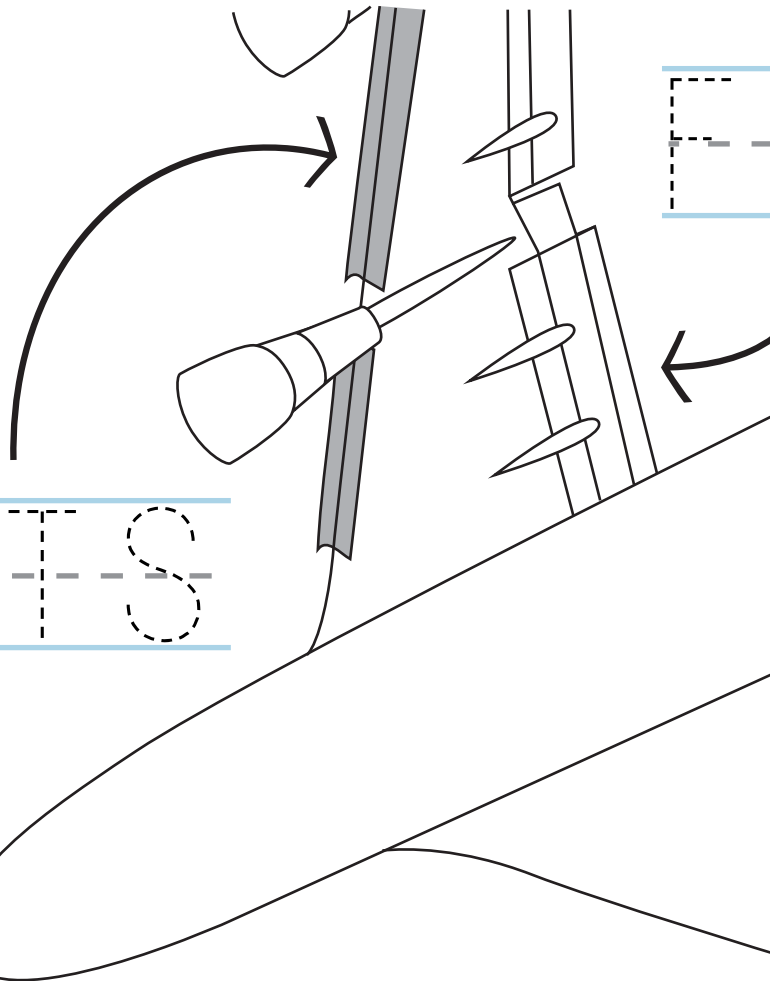

FLAP

SLATS

# Parts of a Plane

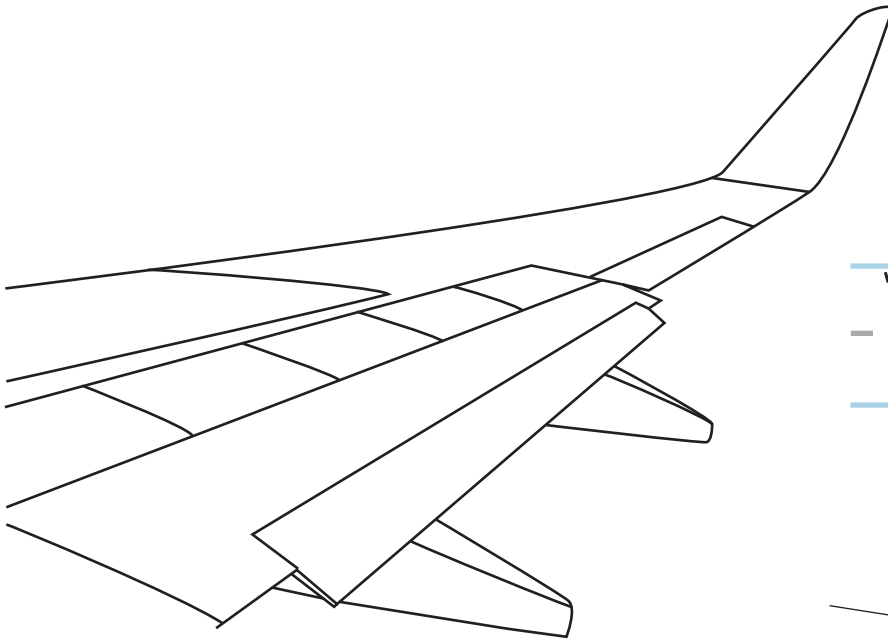
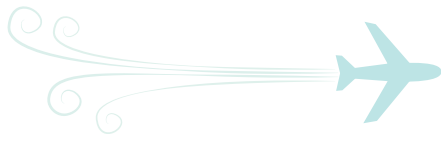

WING

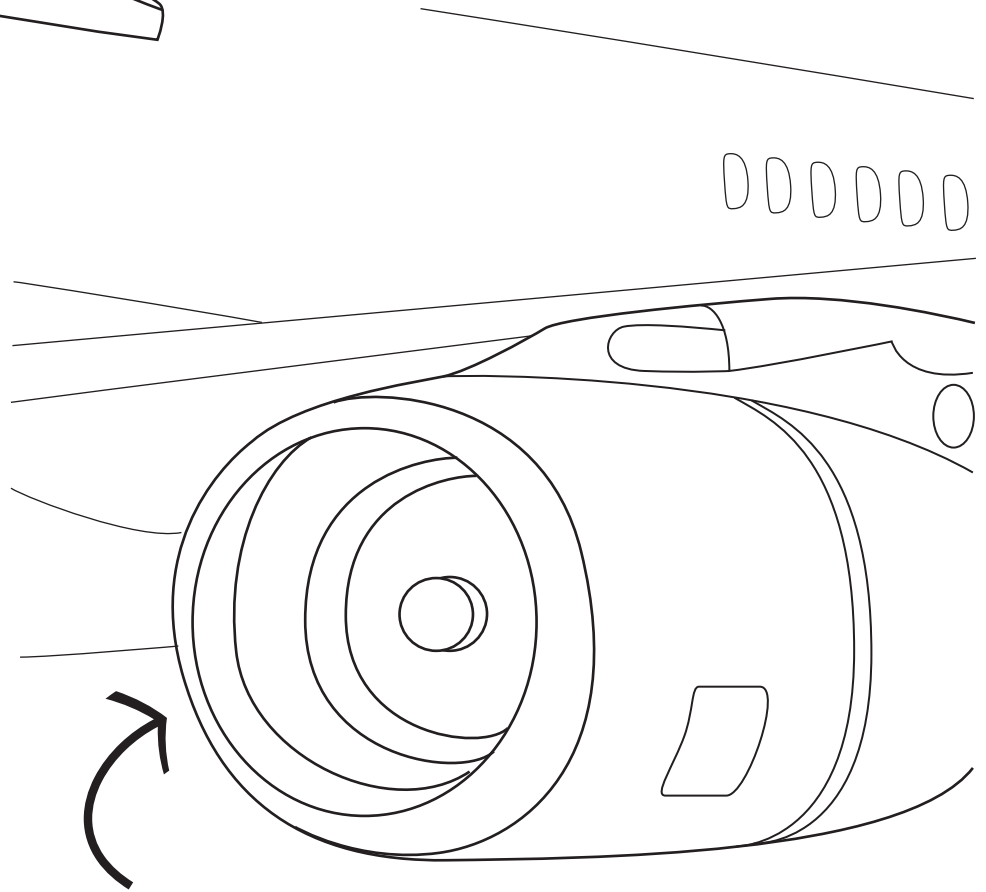

TURBINE ENGINE

# Are You On Board?

Write a **1**, **2**, or **3** under the pictures to show which came first, next, and last.



Can you see out of a window? Put what you can see on the page.

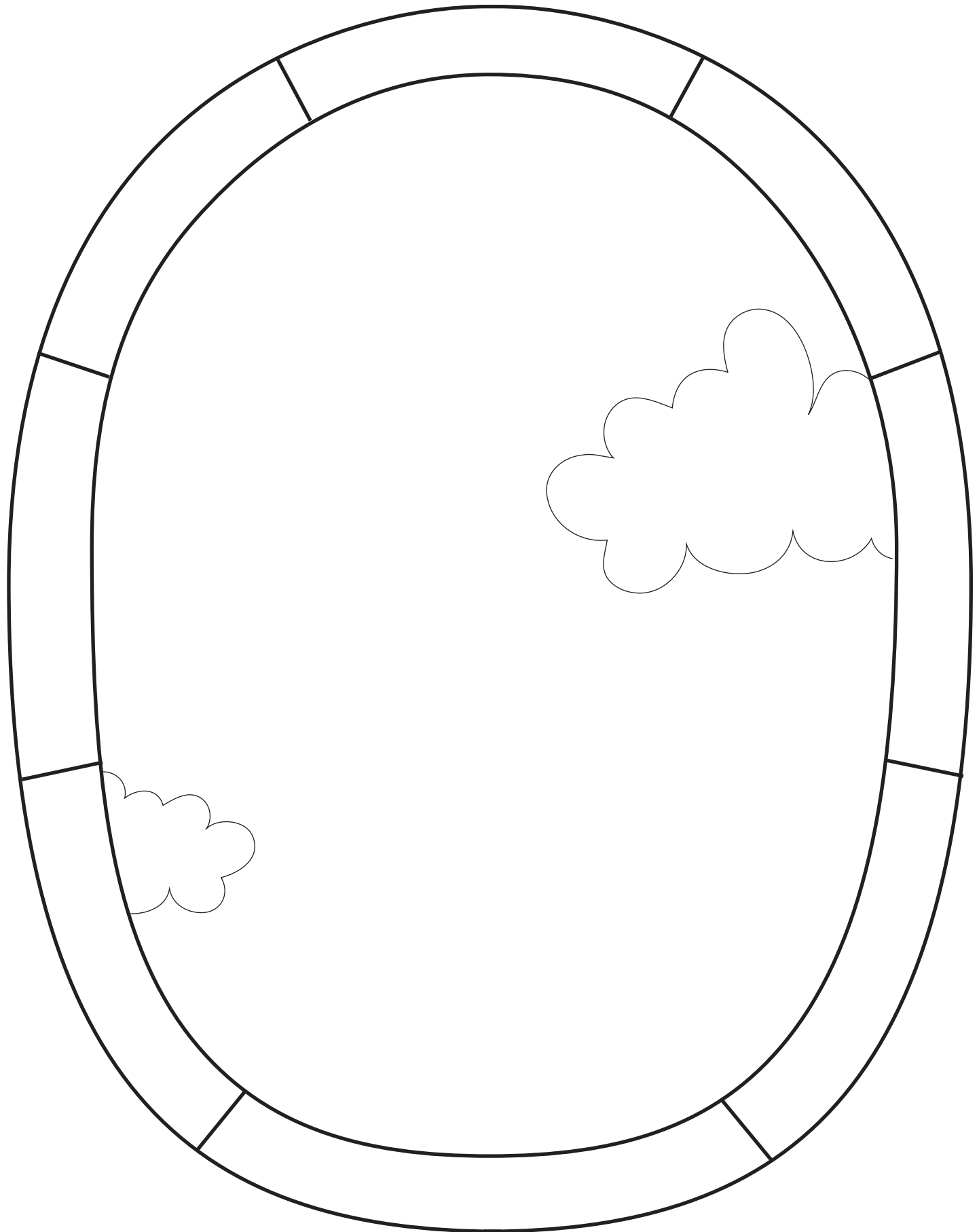

# Ready for Takeoff!

The air traffic control tower helps direct planes that are flying in and out of the airport. Help the air traffic controllers get a message to this plane so it can take off!

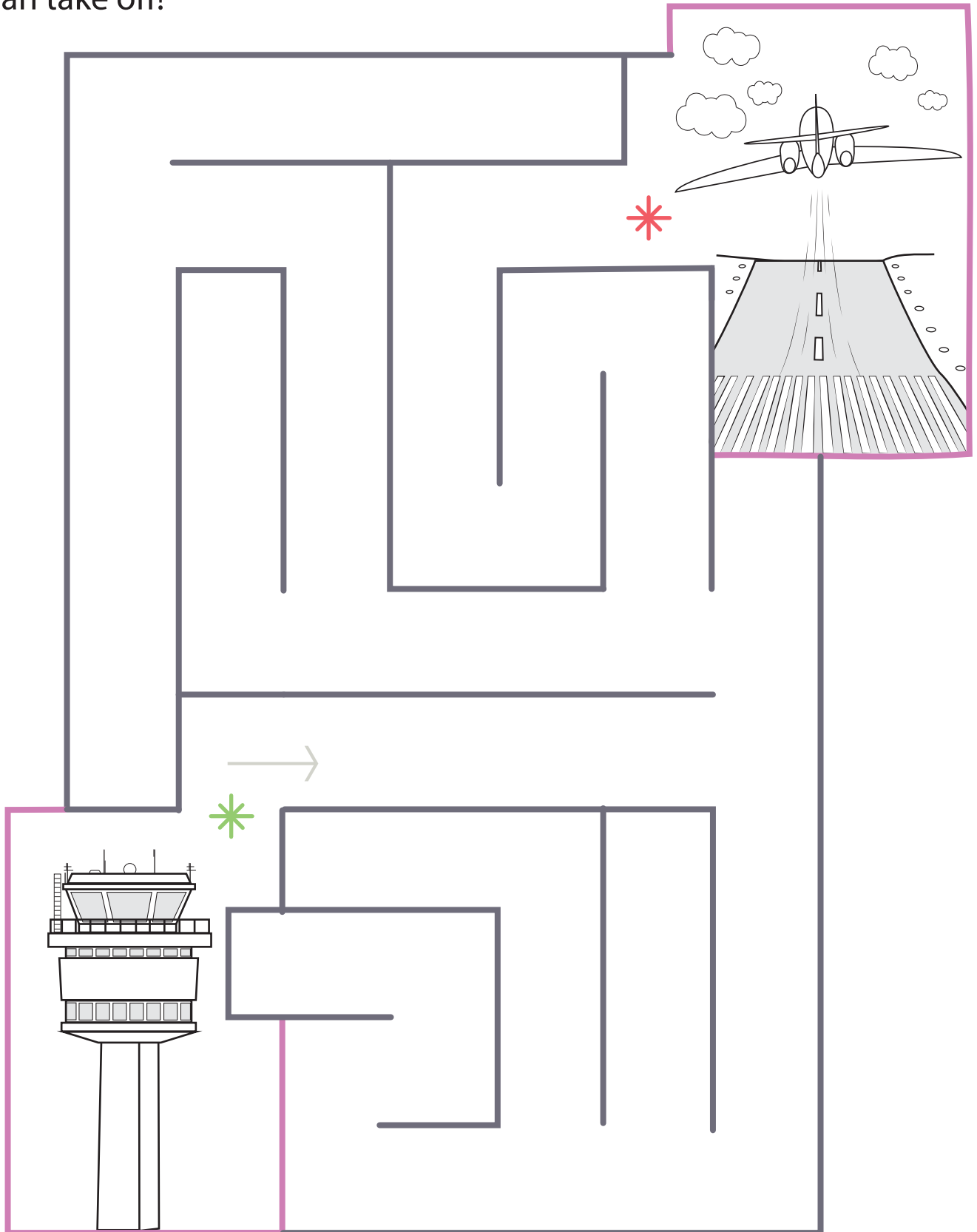

# Complete the Word!

Match the missing letter to complete the flight-related words.

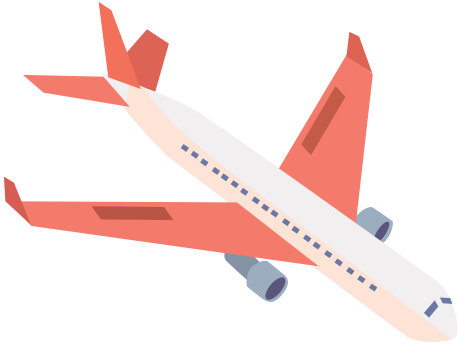

\_\_lane

s



\_\_loud

c



\_\_ird

s

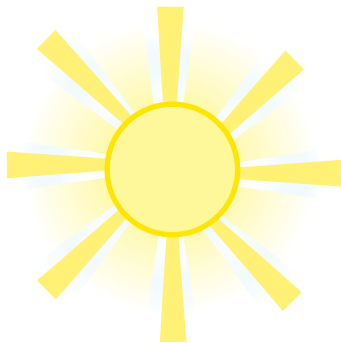

\_\_un

b



\_\_uitcase

p

# Where Are They Headed?

Trace the dots to find out where these planes are headed. Then, give your planes a little color.

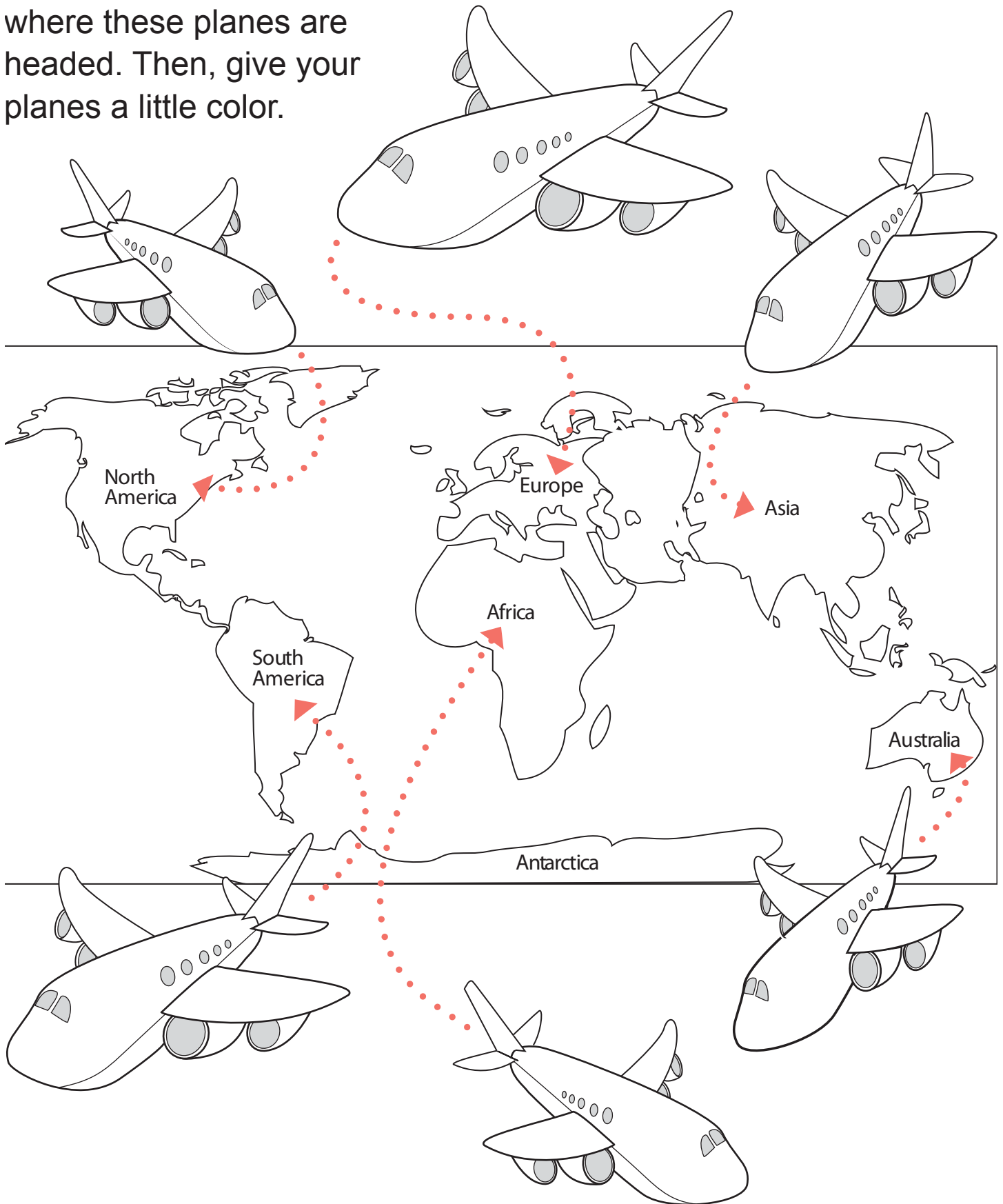

# What's Different?

Color in the two scenes. When you're finished, find and circle five differences between the two pictures.

1.



2.





# How Many?

Count the number of items in each row and write how many there are. Then practice writing the numbers.



7

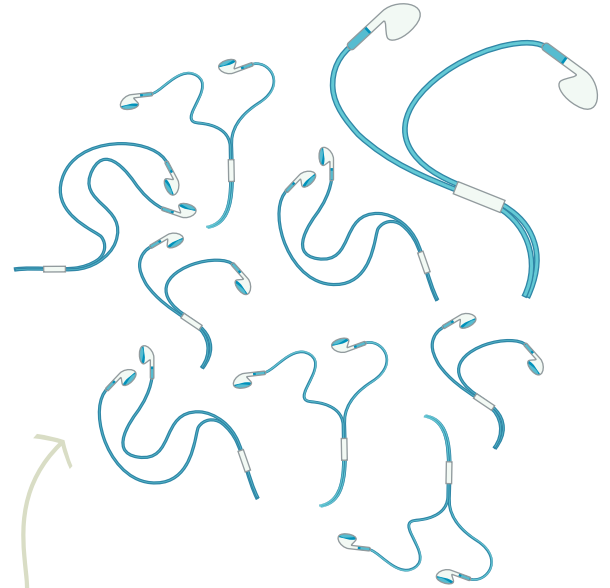

9



8



4



5

- 1: Red
- 2: Blue
- 3: Yellow
- 4: Orange
- 5: Green
- 6: Purple

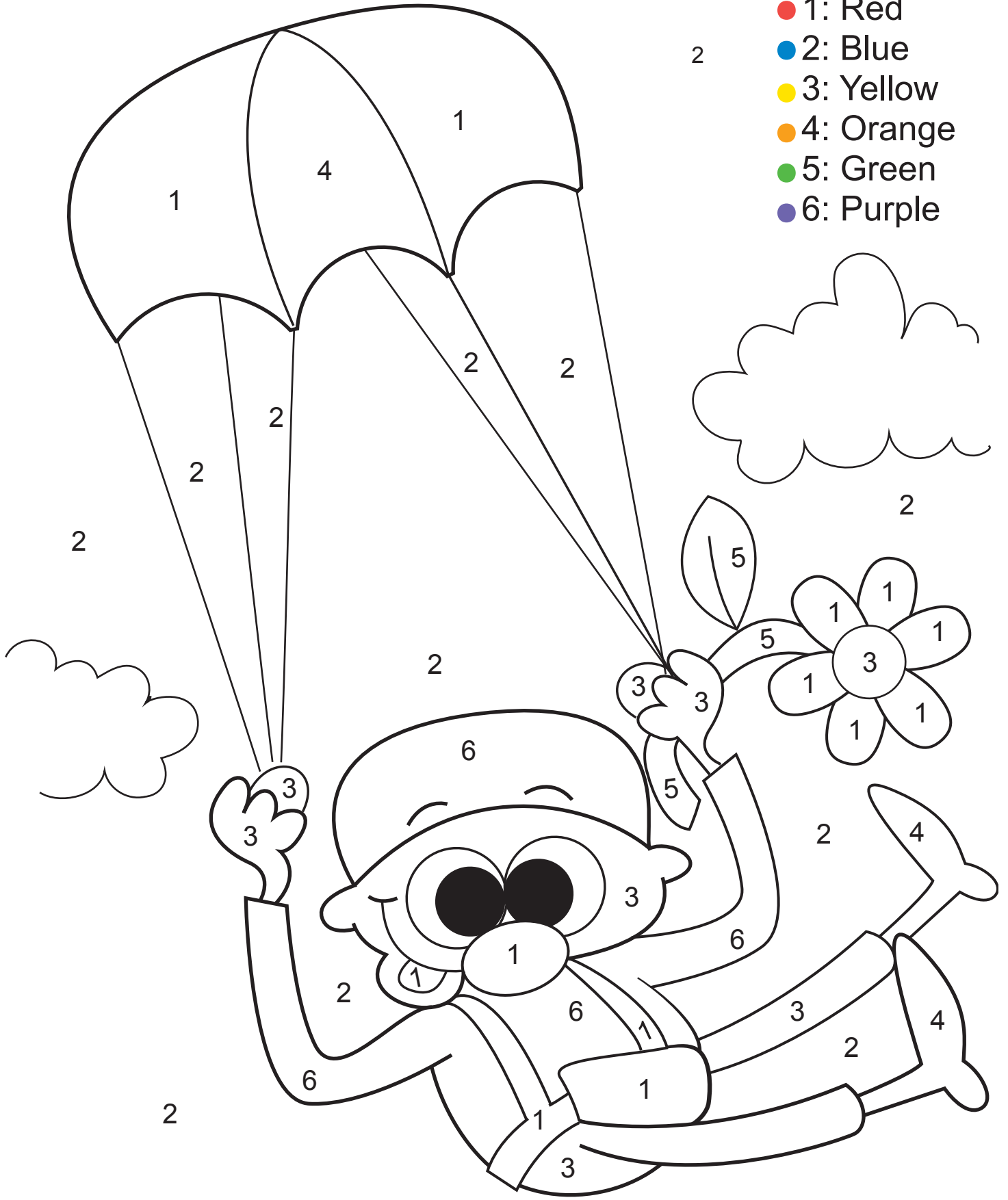

# Trip Fun Words



These action words describe what you might do during your trip.  
Find the words to complete the word search.

H M P M F Y N R R N  
M H I O M U U U I S  
F W A L K R U N D R  
S E A V X L D H E X  
O D V P W E O Q K F  
F U N L E A T O F E  
F M X A P U Q B K S  
X Z J Y Z R B B H V  
Z R R H T Y L Q W D  
G H E R M F W T E S

## WORD BANK:

ride

swim

walk

run

look

play

eat



# Make an Airplane Buddy!

An adult or an older sibling may want to help with this one.

**Directions:** Color in the animals. Then, try folding the page in different ways to turn this puzzle into a puppet.

**Parent Tip:** Let your child practice folding the page in half lengthwise and widthwise. The page works like a puzzle to match up animal faces with mouths. Fold the paper in half as few as three times to create a puppet-like toy, and strengthen her writing muscles..



## Hippo Fun Facts:

Hippos have a special membrane that covers their eyes so they can see underwater

Hippos eat for up to six hours a day!

Hippos spend most of their lives in water.

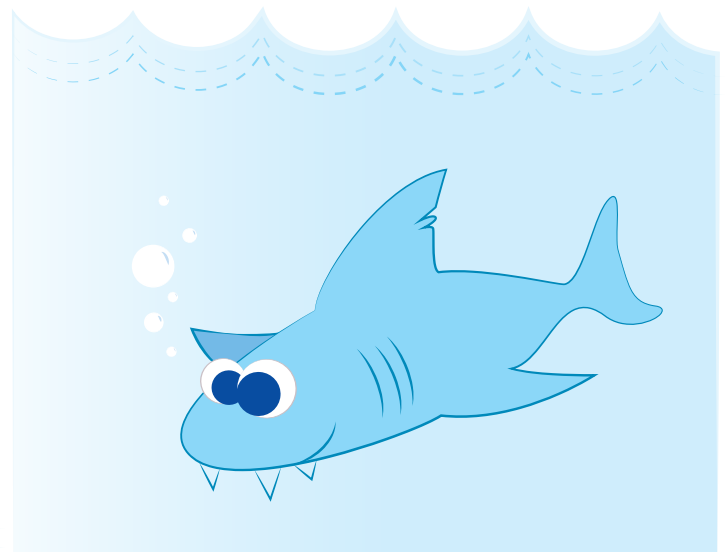

## Shark Fun Facts:

Sharks don't chew their food before swallowing it.

Each year, more people are attacked by pigs than by sharks.

Sharks' eyesight allows them to see what's behind them almost as well as they can see what's in front of them

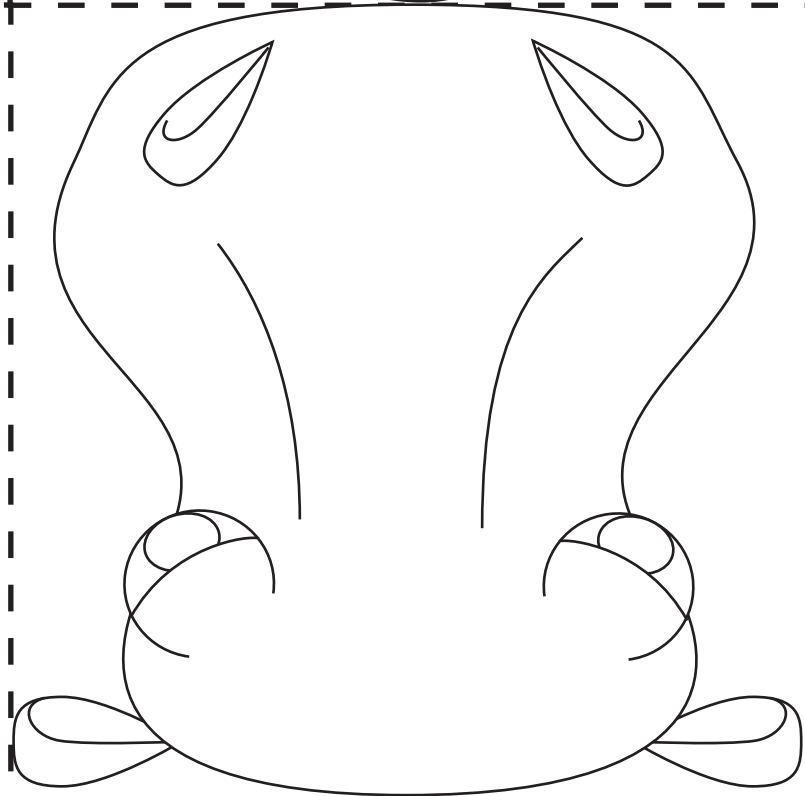
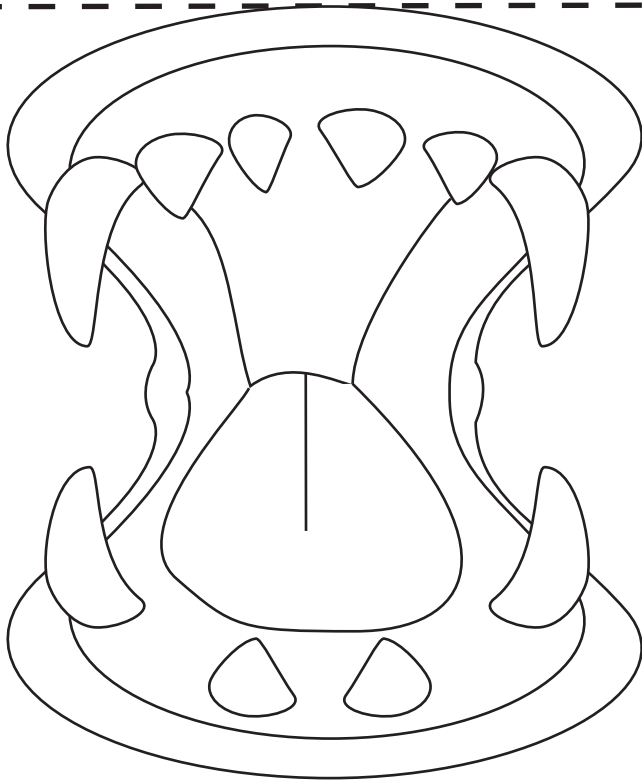
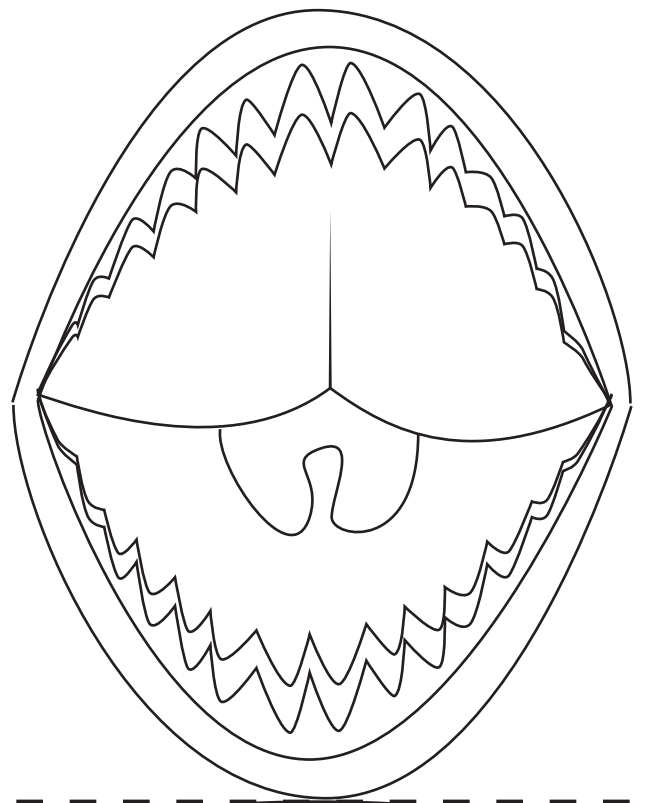
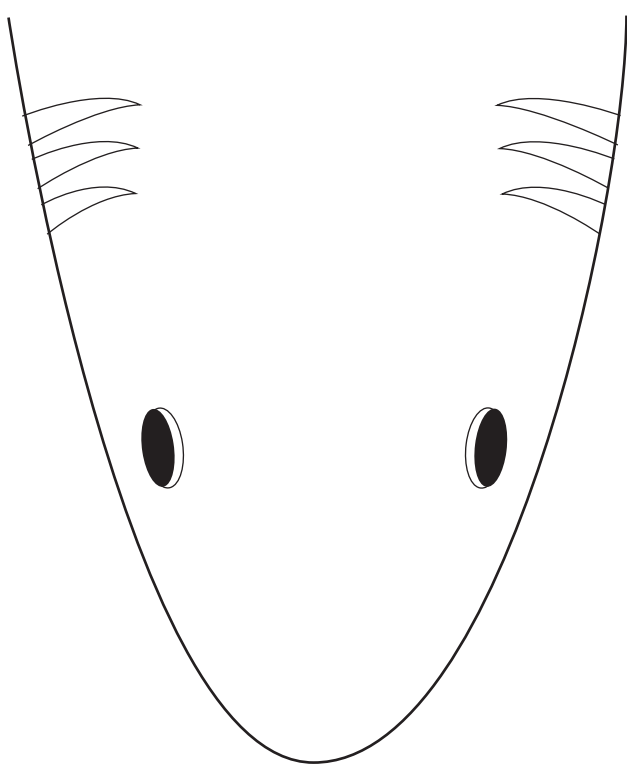

This excess part of the paper can be cut off or creased and torn off.

# Shapes on a Plane

Find and circle all the different shapes you see.

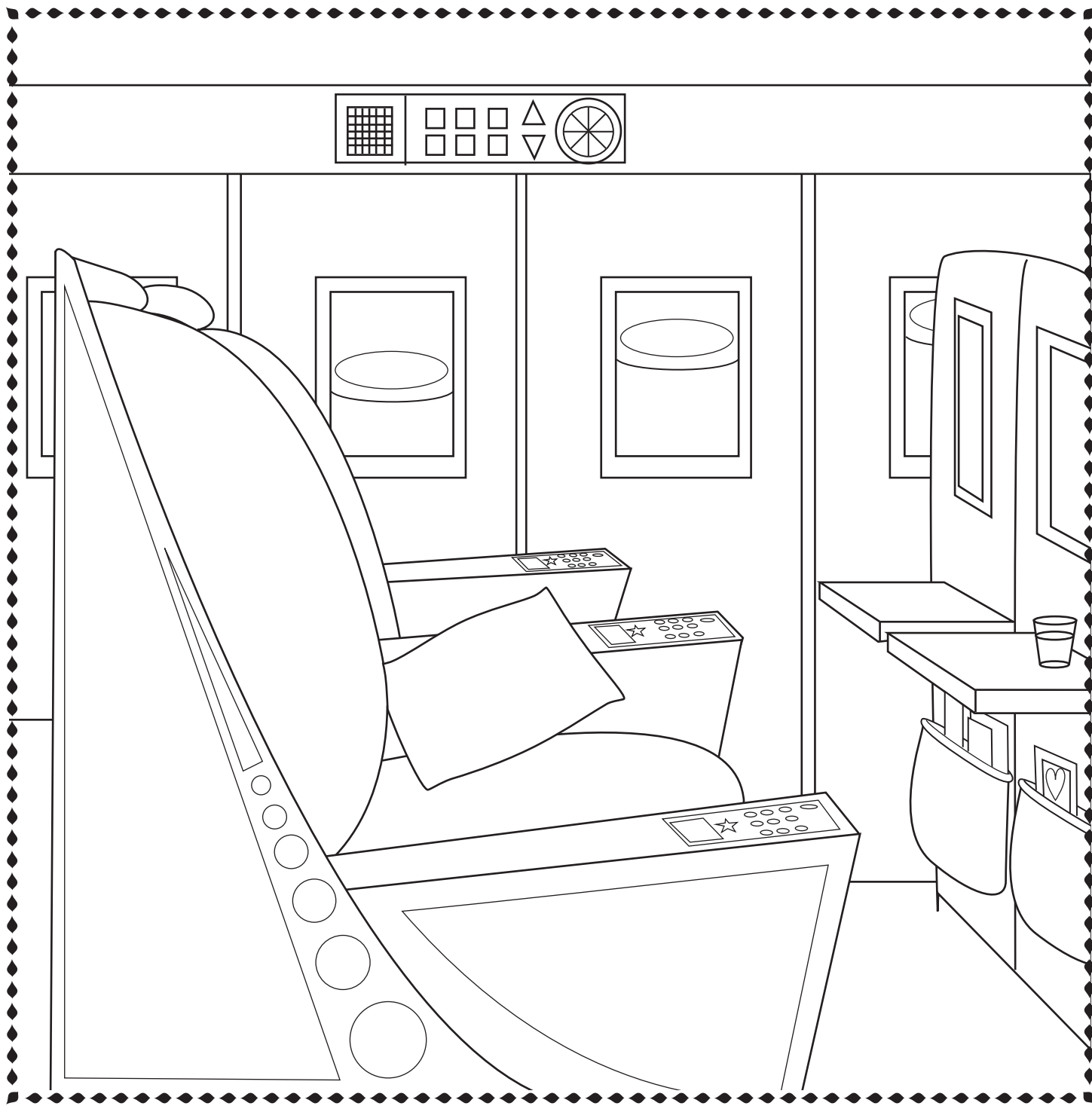

# Check out the View!

Look out the window. Do you see land below? Draw a river through this mountainous maze.

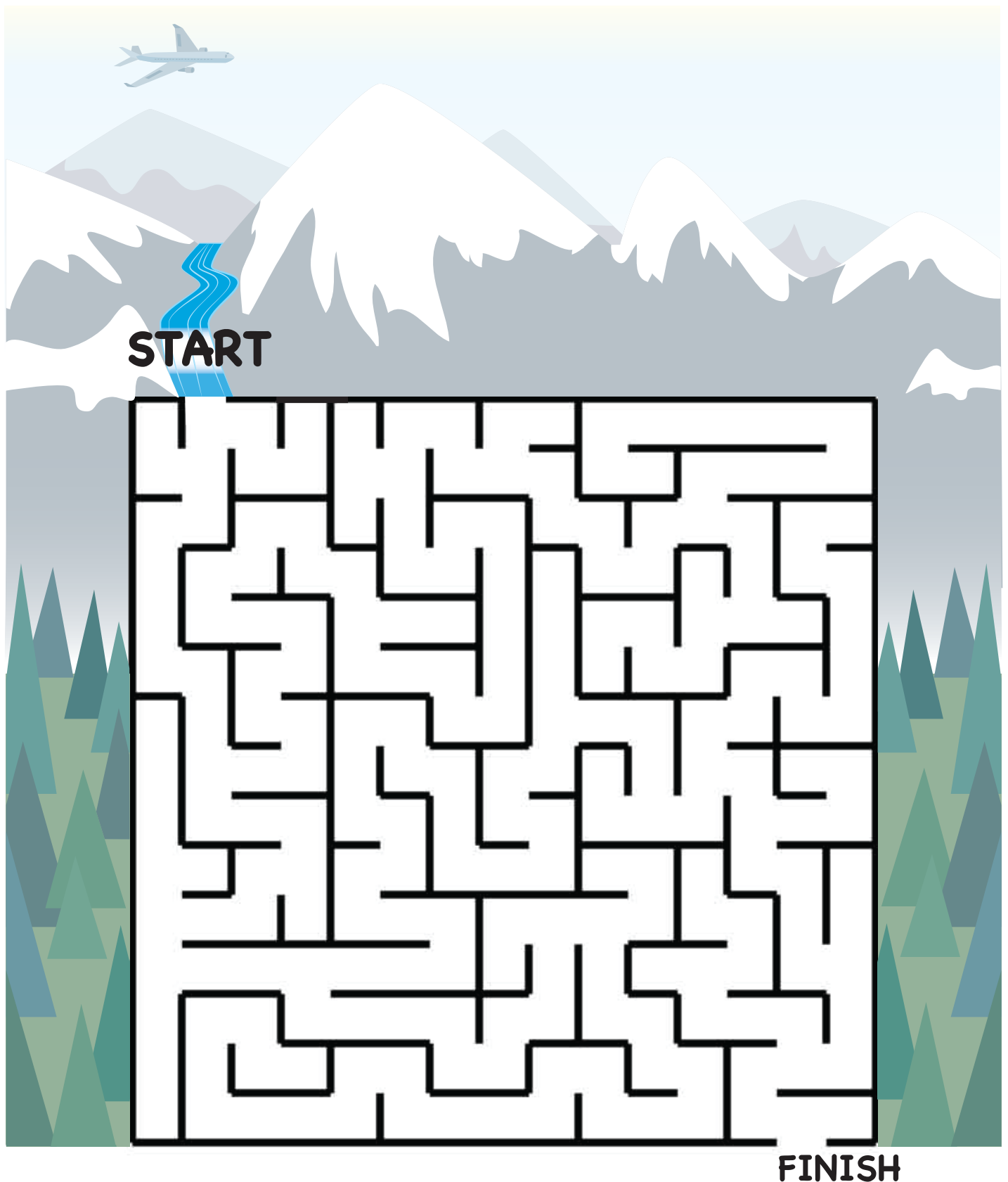

# Complete the Word

Match the missing letter to complete the word.



\_\_ravel

j



\_\_acation

t



\_\_ourney

d

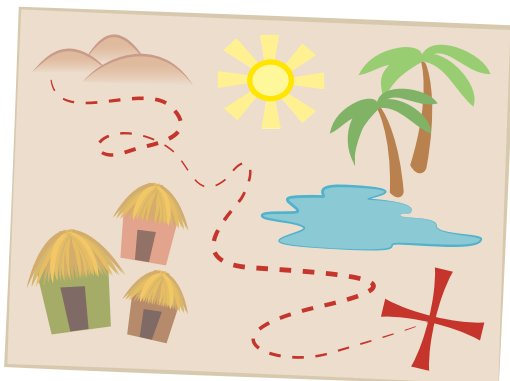

\_\_dventure

v







# Check out the View!

During your flight, you might pass over water. Imagine, then draw all the different kinds of things you might see on the surface of the water, as well as what swims below.

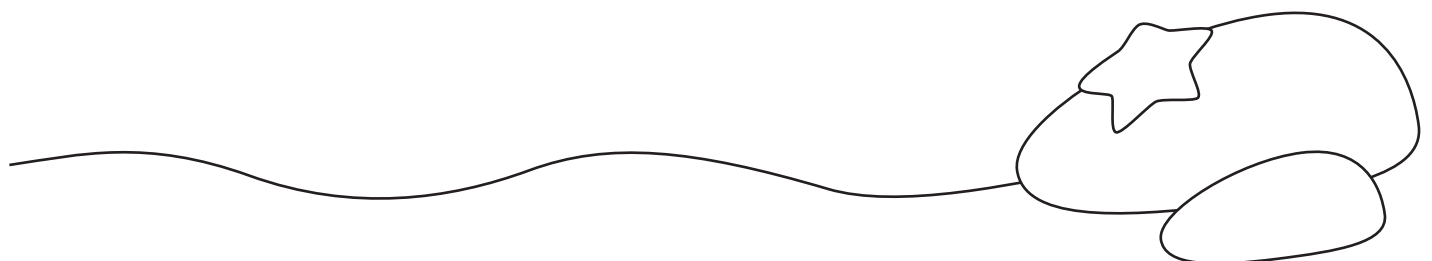
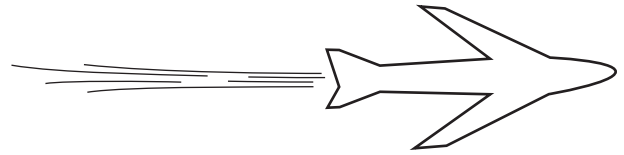





# COLOR BY NUMBER!

Make A Stained Glass Creation

- 1: Red
- 2: Blue
- 3: Yellow
- 4: Orange
- 5: Green
- 6: Purple

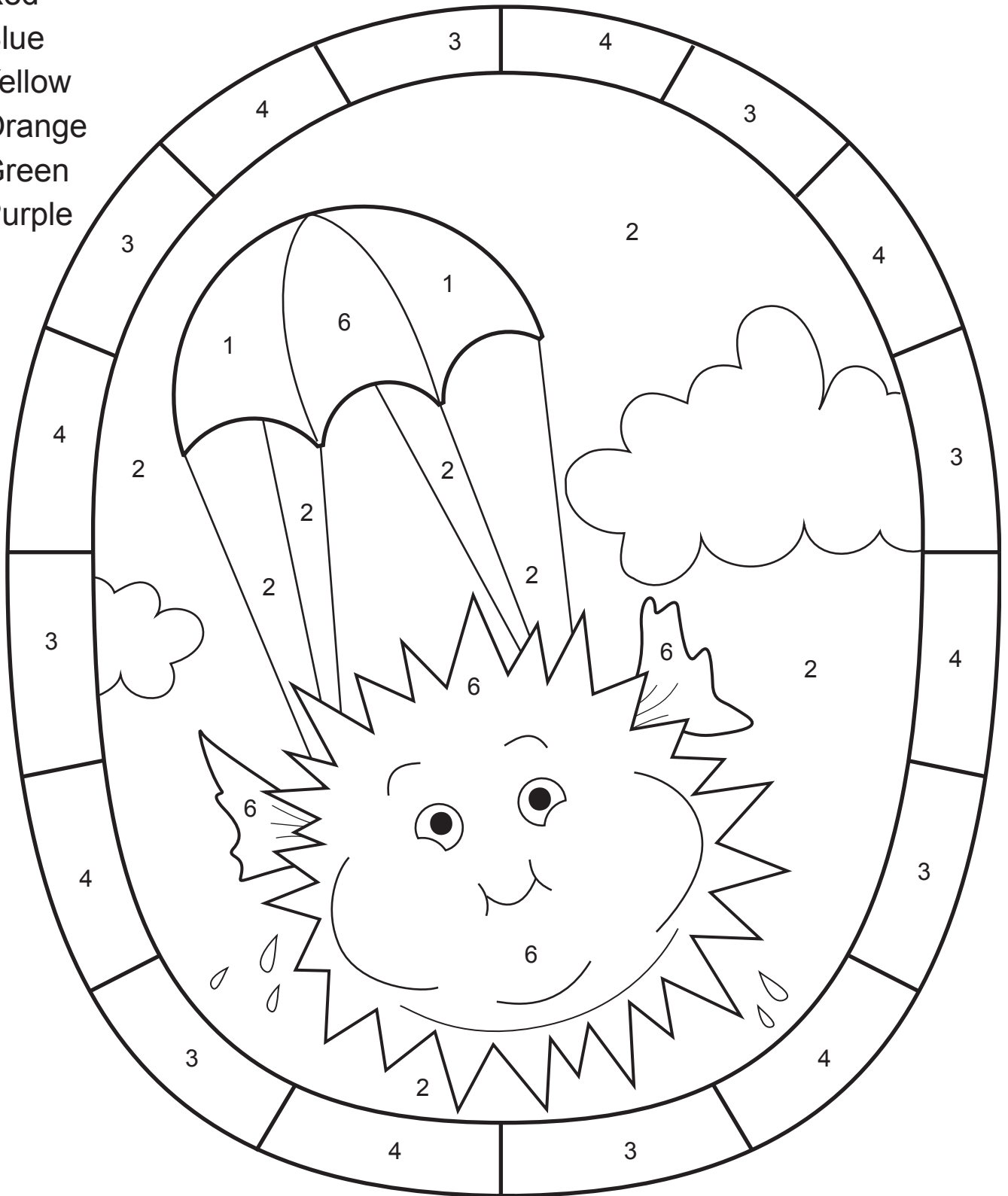

If you're sitting in a window seat, hold your colorful page up to the window. If you're in a center or aisle seat, simply turn on the light above you and hold up your page.

# Color by Number

- 1: Red
- 2: Blue
- 3: Yellow
- 4: Orange
- 5: Green
- 6: Purple

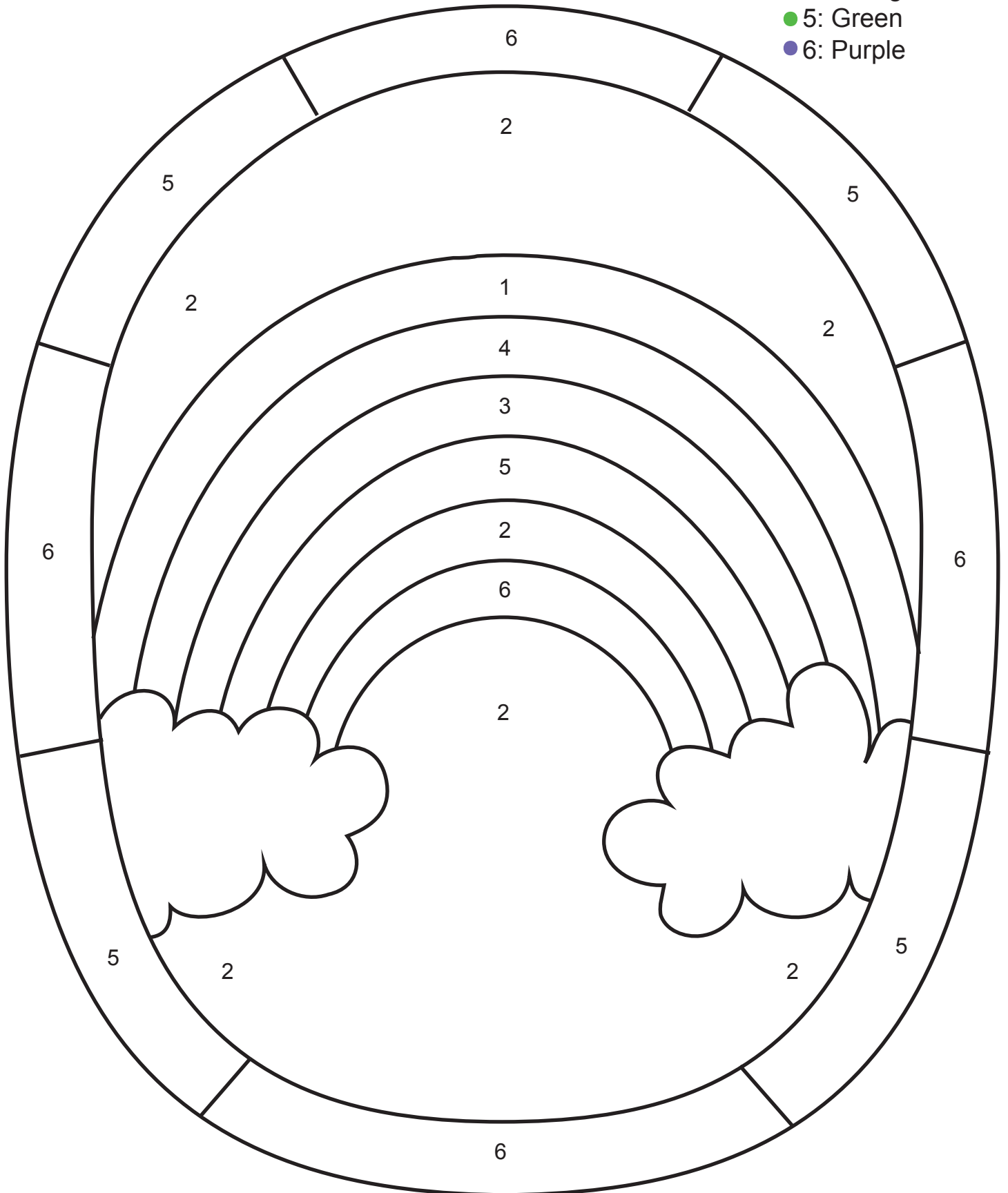

# Bird's-Eye-View

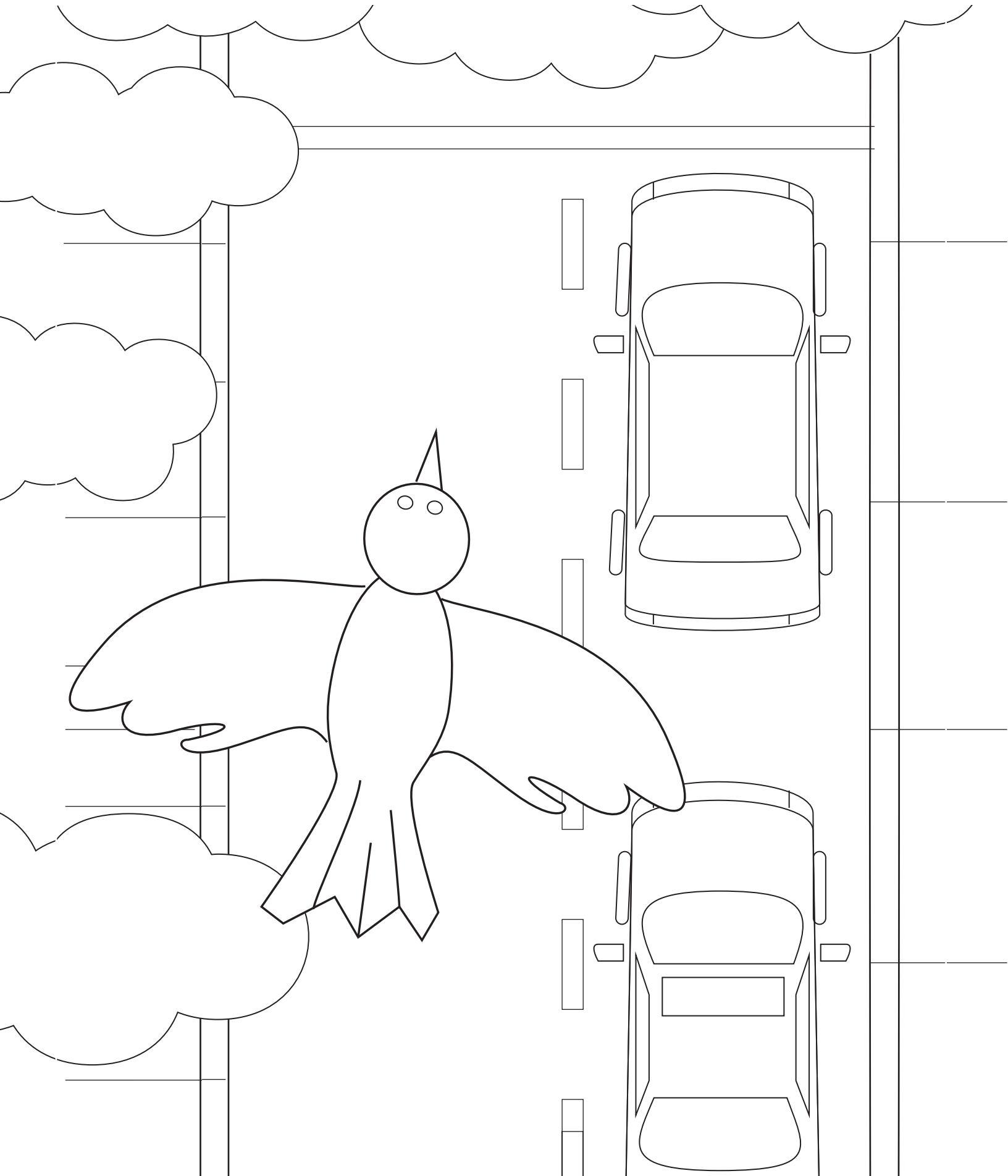

# Exit the Plane!

Write a **1**, **2**, or **3** under the pictures to show which came first, next, and last.

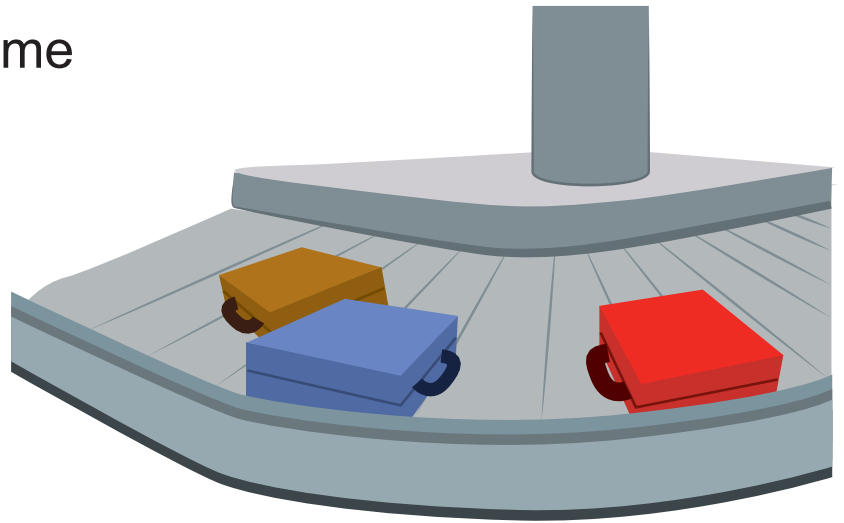

\_\_\_\_\_



\_\_\_\_\_

\_\_\_\_\_





# Airport Maze

Airports are like a maze sometimes. Help the pilot and his crew get to their plane on time.

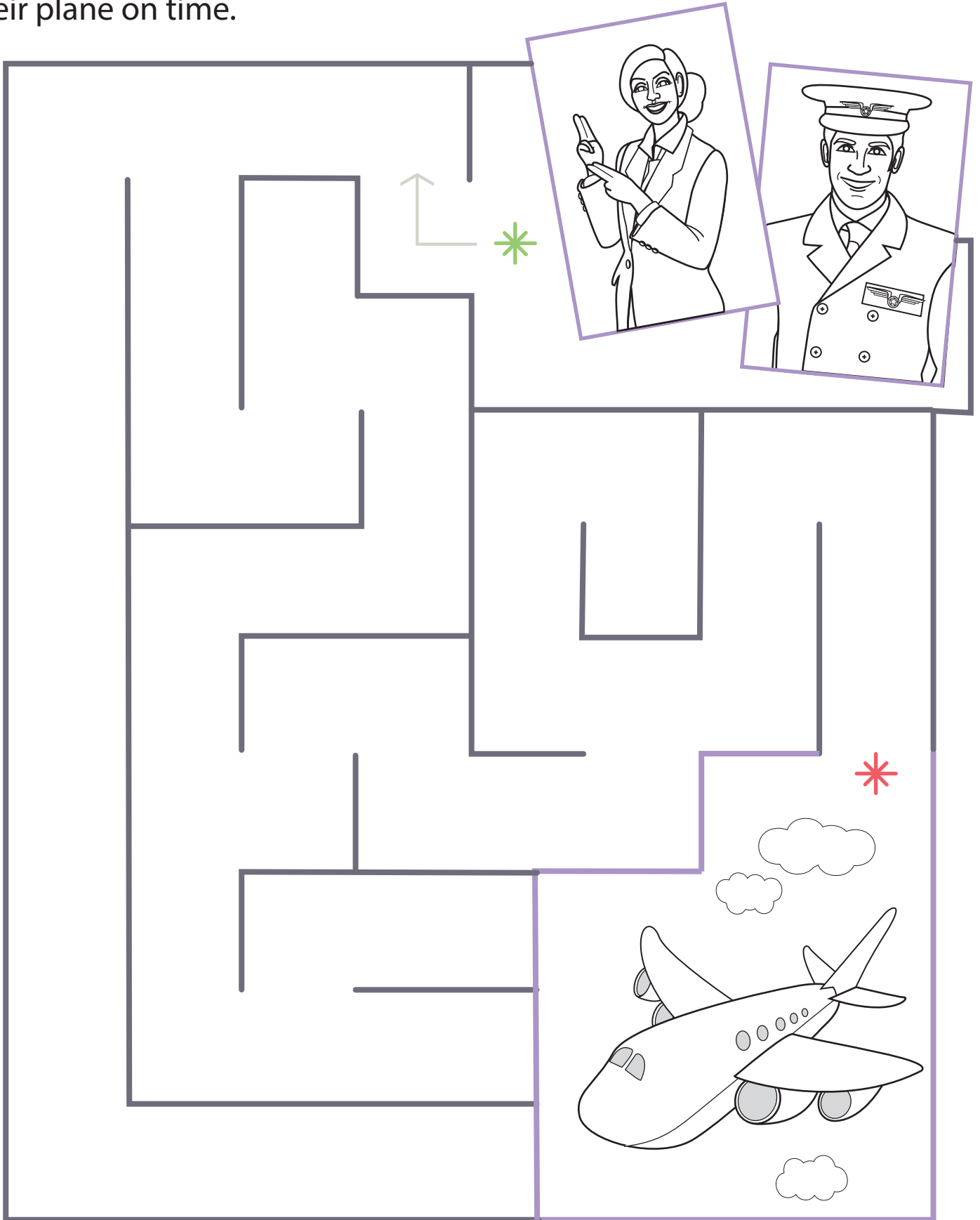

# Vacation Sight Words

**Directions:** Parents, read the words out loud along with your child. During your trip this page can be used like a bingo card to practice reading and recognizing words when heard, or, torn into sight words cards.

Use some of these plane and vacation sight words to talk about your trip! Ask your child to color in any rectangles with words that she can read, or, that she recognizes when she hears them.

airport	cab	vacation	takeoff	flew
airplane	camera	visit	ticket	fly
ate	bus	voyage	tourist	food
backpack	carry-on	walk	ship	fun
baggage	coast	wander	museum	go
beach	cruise	travel	outdoors	journey
bike	drove	sights	pack	leave
boat	explore	sun	photo	map
bus	trip	swim	play	run
landing	unpack	swimsuit	ran	rest

# Draw a picture

Draw a picture of what you are going to do once you reach your destination.  
Or, if you're on your way home, draw some of the fun stuff you've already done.





**Great job!**

---

is an [ThuVienTiengAnh.Com](http://ThuVienTiengAnh.Com) writing superstar

