

**WEEK 1**



**FALL**  
**REVIEW PACKET**

**5 Days of Activities**



Reading

Writing

Math

Other Fun Stuff

# Helpful Hints

## Materials You Will Need:

- Pencils
- Colored pencils, markers, or crayons for some of the activities
- Scissors, glue, and other materials for some of the activities





## Directions & Tips:

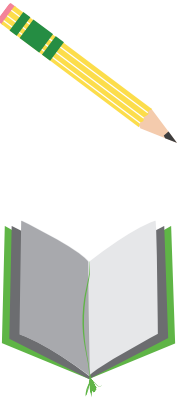

- There is a schedule for each day. You may complete the activities in any order.
- Make sure to plan your time so that you don't let things pile up at the end.
- Read the directions carefully before completing each activity.
- Check off each of the activities when you finish them on the menu.

# Activity Menu

	Day 1	Day 2	Day 3	Day 4	Day 5
<p><b>Literacy</b></p> 	<p>Uppercase Alphabet in Color</p> <p>Find the Letter A: Did You Ever See a Lassie?</p> <p>First, Next, Last</p>	<p>Connect the Dots with Uppercase Letters: Whale</p> <p>Find the Letter M: Do You Know the Muffin Man?</p> <p>The Color Red</p>	<p>Connect the Dots with Lowercase Letters: Shark</p> <p>Find the Letter T: Twinkle, Twinkle, Little Star</p> <p>Animal Roundup</p>	<p>Hidden Image</p> <p>Find the Letter P: Peter Piper</p> <p>The Color Orange</p>	<p>Beginning Letter Sounds: Matching</p> <p>Find the Letter O: Little Boy Blue</p> <p>How Many Words Are There?</p>
<p><b>Math</b></p> 	<p>Counting Practice: 1-10</p> <p>Number Line</p>	<p>Circle the Number</p> <p>Color By Numbers: Kite</p>	<p>Counting Raindrops</p> <p>Writing Numbers Many Ways</p>	<p>Counting Animals: Birds</p> <p>Get on Track</p>	<p>Ordering Numbers to 10</p> <p>Order 'Em Up!</p>
<p><b>Fun Stuff</b></p>	<p>My Parent's Phone Number</p>	<p>Nursery Rhyme Coloring: Hot Cross Buns</p>	<p>Categorizing</p>	<p>Animal Alphabet Placemat</p>	<p>Wash Your Hands</p>

# DAY 1



<b>Literacy</b>	<p>Color in each uppercase alphabet letter.</p> <p>Identify all the letter A's in the poem.</p> <p>Put the pictures in order from first to last.</p>
<b>Math</b>	<p>Practice counting up to 10.</p> <p>Trace and write the numbers 1-10 on the train.</p>
<b>Fun Stuff</b>	<p>Practice writing and dialing your parent's phone number!</p>

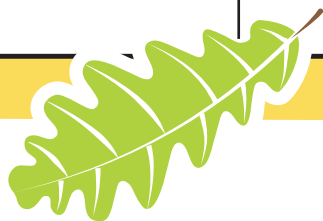

Name .....

Date .....

# Uppercase Alphabet in Color

Have fun coloring in each uppercase letter with a different color of your choice.  
For extra fun, outline each letter with multiple different colors to create a rainbow effect!

A B C D E

F G H I J K

L M N O P

Q R S T U

V W X Y Z



Read the poem. Circle each A that you see.

What is a lassie? Lassie means girl.

Did you ever see a lassie  
A lassie, a lassie?  
Did you ever see a lassie  
Go this way and that?  
Go this way and that way,  
Go this way and that way.  
Did you ever see a lassie  
Go this way and that?



How many A's did you find?

\_\_\_\_\_

-----

\_\_\_\_\_



# FIRST, NEXT, LAST

Cut out the pictures at the bottom of the page. Then paste them in the right order.

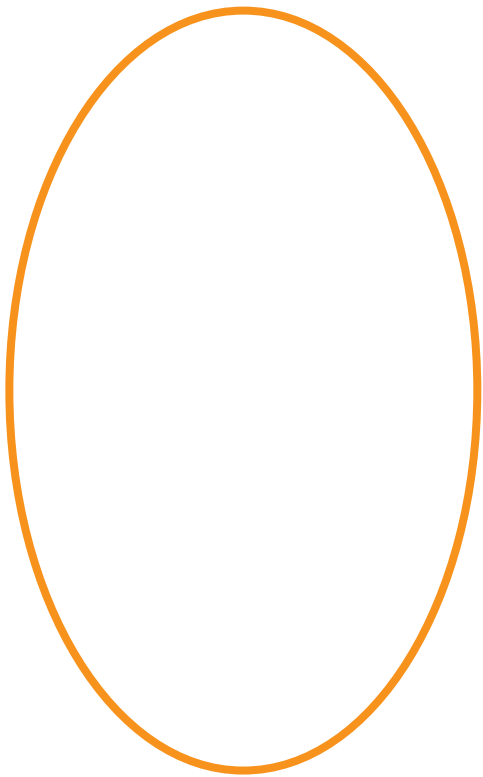

First

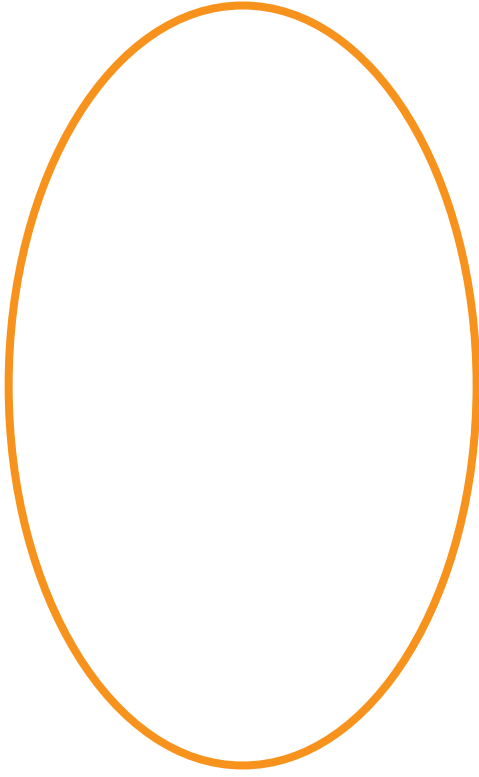

Next

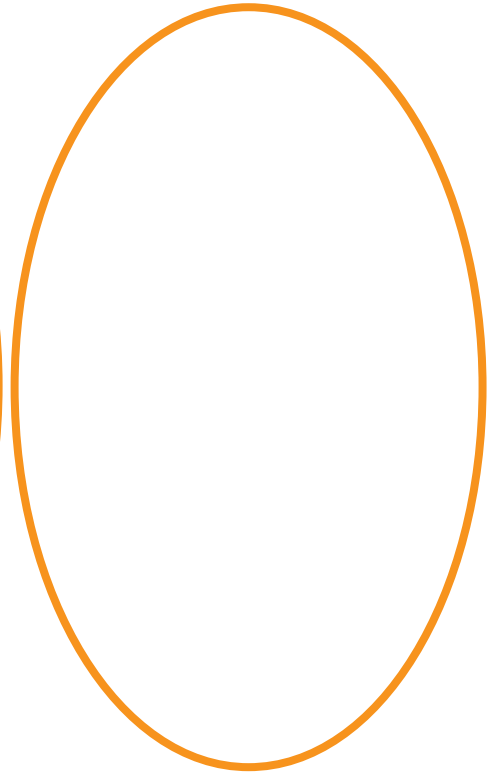

Last

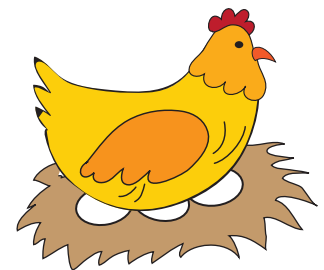
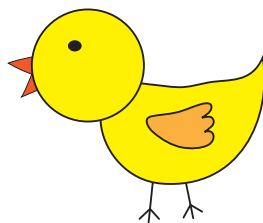
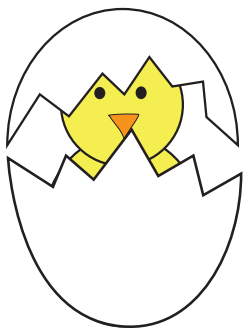

# Counting Practice: 1-10



How many horses do you see? How many chicks do you see?  
Count them out loud.

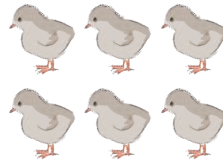
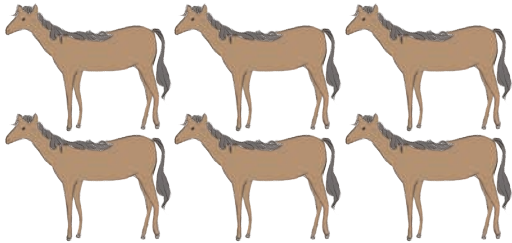

The number of  is the same as the number of .

**Directions:** Count the farm animals and equipment on each card.  
Circle the cards that have the same number.

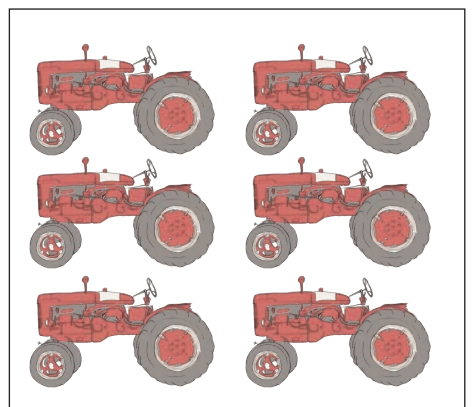
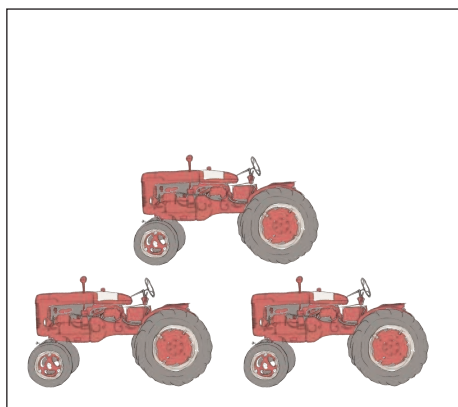
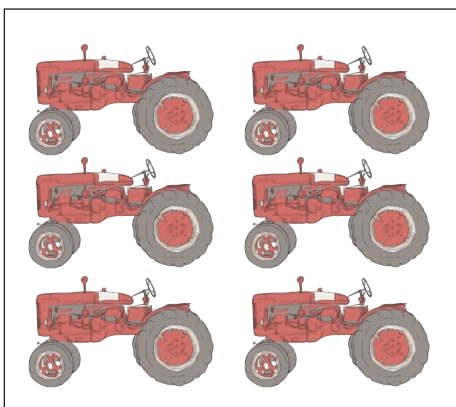
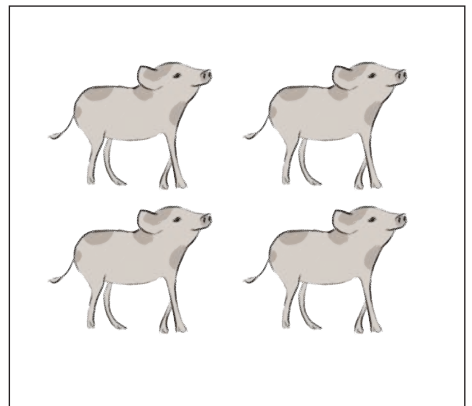
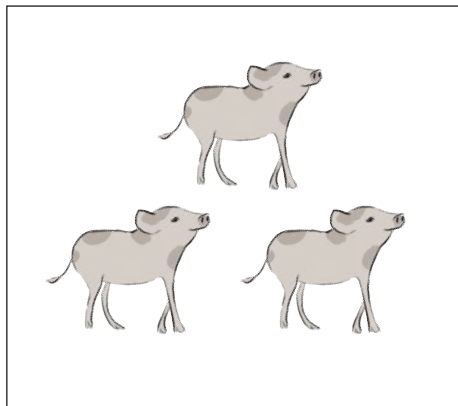
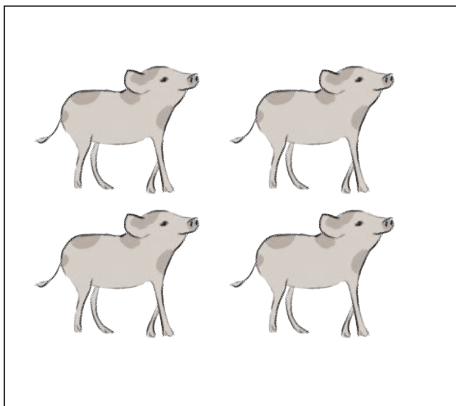



Name \_\_\_\_\_ Date \_\_\_\_\_

# Counting Practice: 1-10

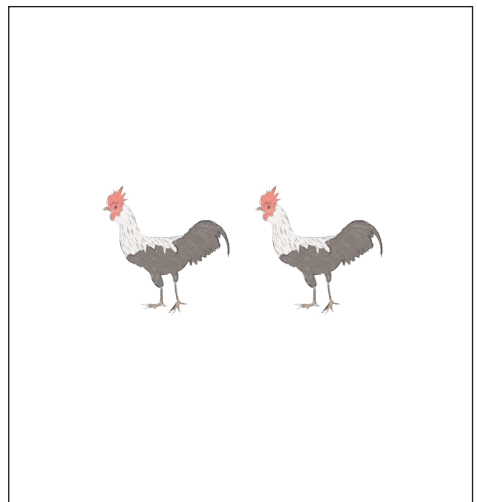
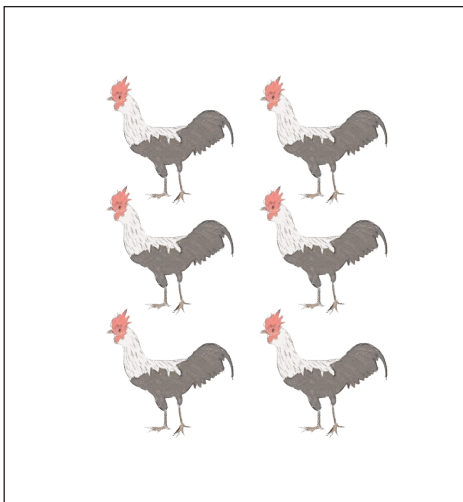
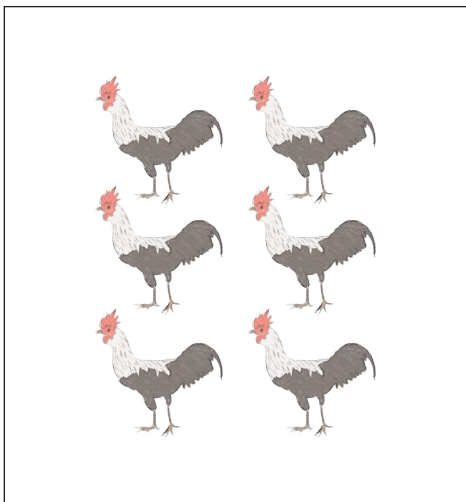
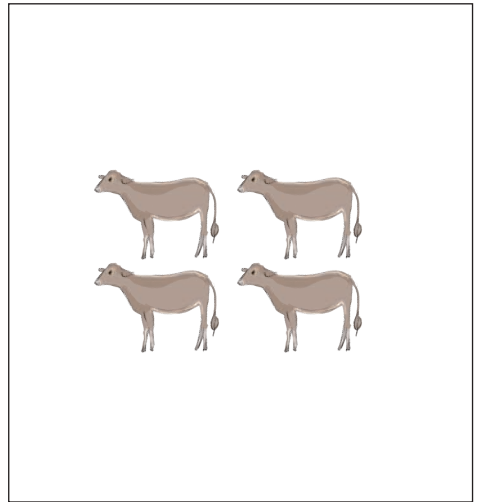
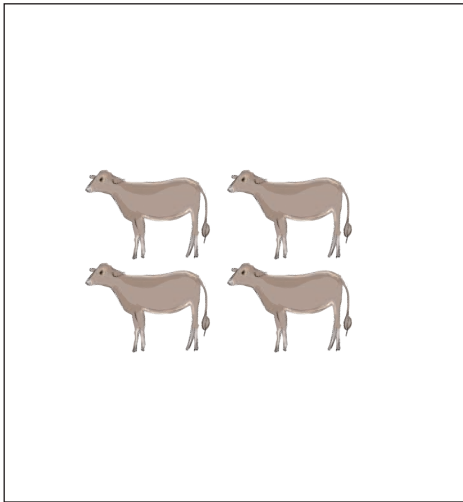
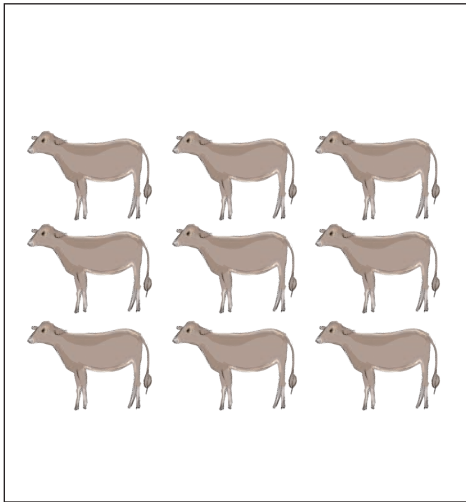
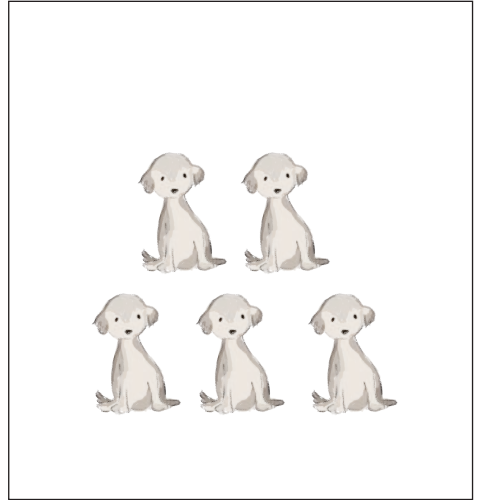

Name \_\_\_\_\_  
Date \_\_\_\_\_

# Number Line

Trace numbers 1-10.

1 2 3 4 5 6 7 8 9 10

Try it yourself! Write numbers 1-10.

1 2 3 4 5 6 7 8 9 10

Name \_\_\_\_\_

Date \_\_\_\_\_

# My Parent's Phone Number



Write your parent's phone number on the blanks below. Then, practice dialing their phone number on the telephone buttons below.

\_\_\_\_\_-\_\_\_\_\_-\_\_\_\_\_-\_\_\_\_\_-\_\_\_\_\_-\_\_\_\_\_-\_\_\_\_\_-\_\_\_\_\_-\_\_\_\_\_-\_\_\_\_\_-

1	2 ABC	3 DEF
4 GHI	5 JKL	6 MNO
7 PQRS	8 TUV	9 WXYZ
*	0	#

# DAY 2



## Literacy

Connect the dots in alphabetical order.

Identify all the letter M's in the poem.

Make a book about the color red!

## Math

Count the objects and circle the number to tell how many.

Color the kite by identifying numbers.

## Fun Stuff

Read the nursery rhyme and color the picture.

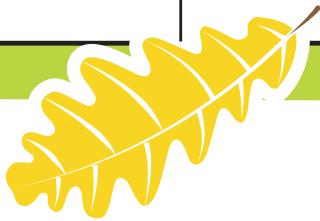

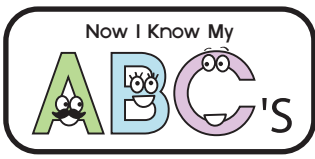

Connect the Dots with Uppercase Letters: Whale

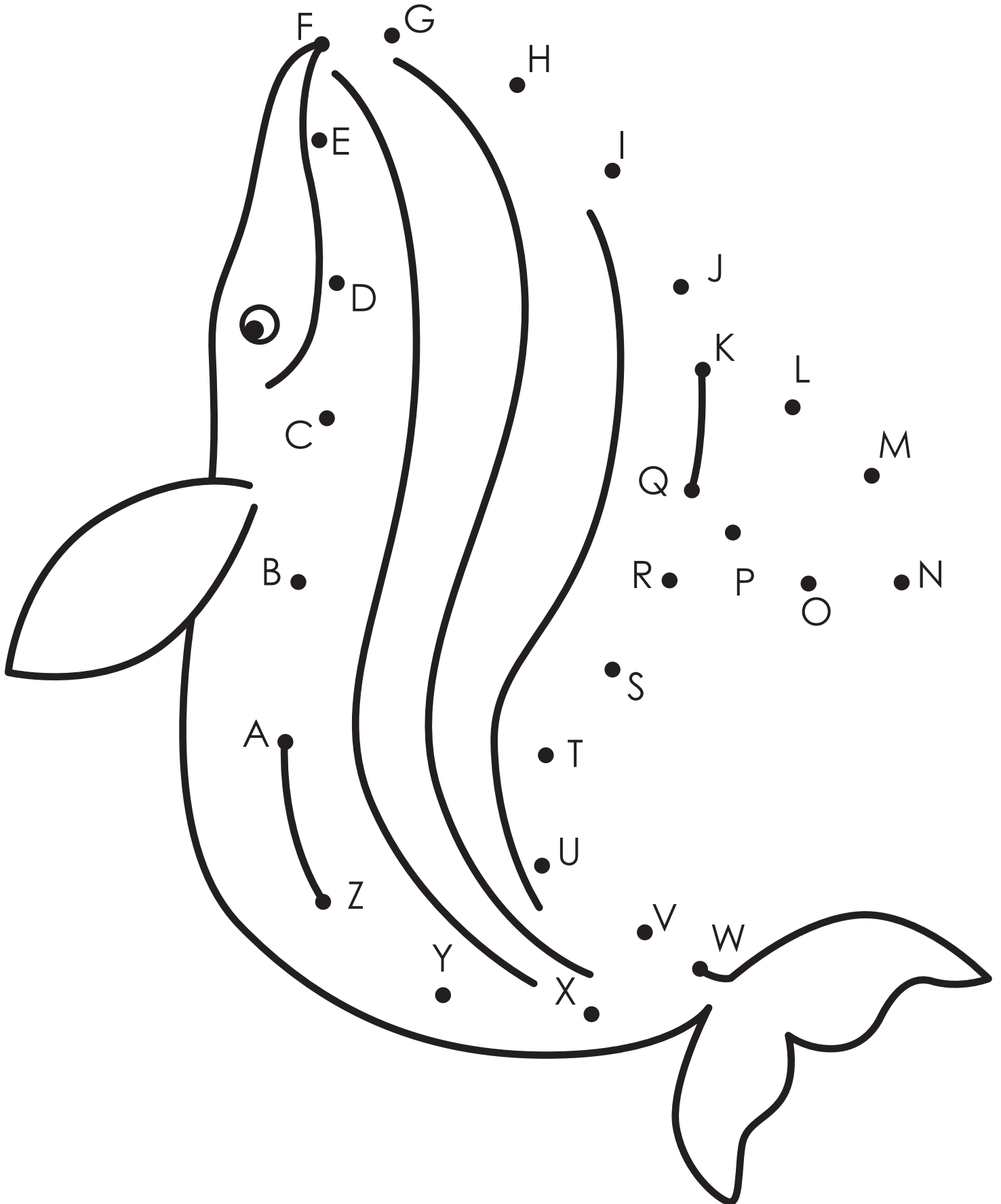



Read the poem. Circle each M that you see.

Do you know the Muffin Man,  
The Muffin Man,  
The Muffin Man?

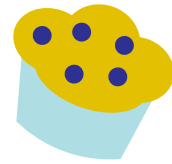

Do you know the Muffin Man  
Who lives in Drury Lane?

Yes, I know the Muffin Man,  
The Muffin Man,  
The Muffin Man.

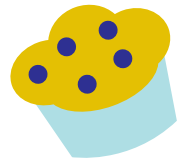

Yes, I know the Muffin Man  
Who lives in Drury Lane.

How many M's did you find?

\_\_\_\_\_

-----

\_\_\_\_\_



\_\_\_\_\_'s  
Book of Red



The apple is red.

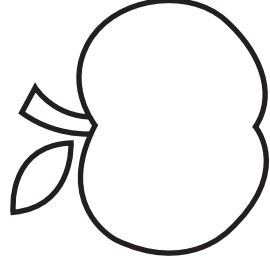

The balloon is red.

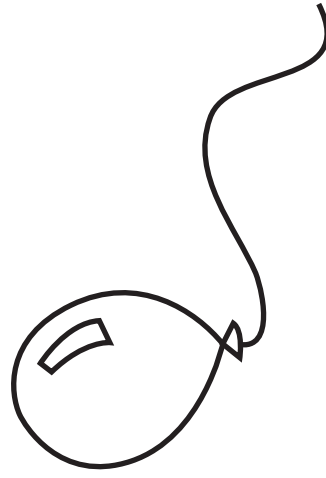

The heart is red.

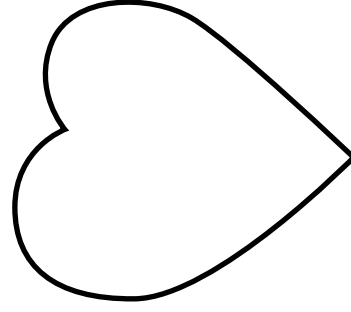

To make your book of red, first write your name. Then, use red to trace the words and color the pictures. When you are done, cut the pages on the dotted lines and have your parent staple them together!

# Circle the Number

Circle the number that matches the amount of objects.



4 5 7

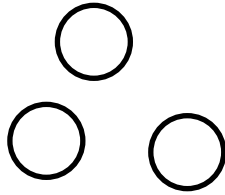

1 2 3

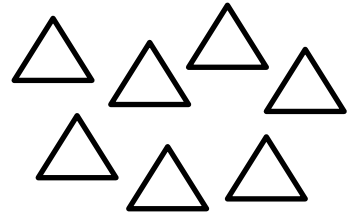

4 7 9

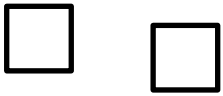

2 4 6

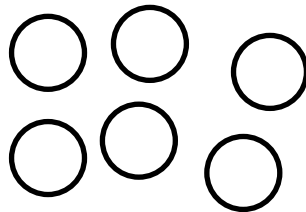

6 7 8



0 1 9

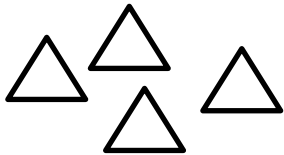

3 4 5

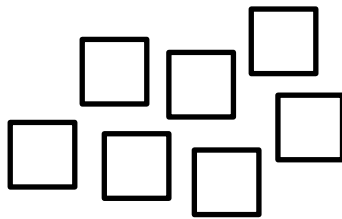

7 8 9

0 9 2

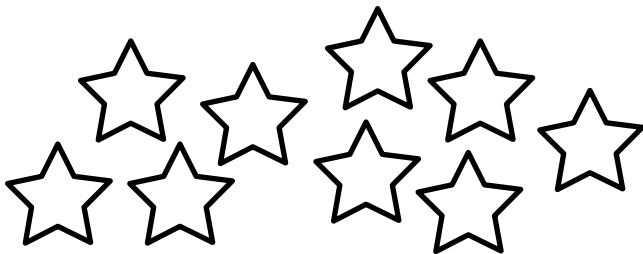

7 8 9

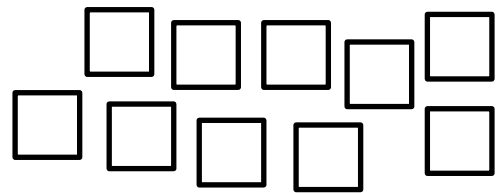

1 4 10



Name: \_\_\_\_\_

Date: \_\_\_\_\_

## Color by Numbers: Kite

Color the kite according to the color key.

1 = **Green**

2 = **Yellow**

3 = **Red**

4 = **Blue**

5 = **Purple**

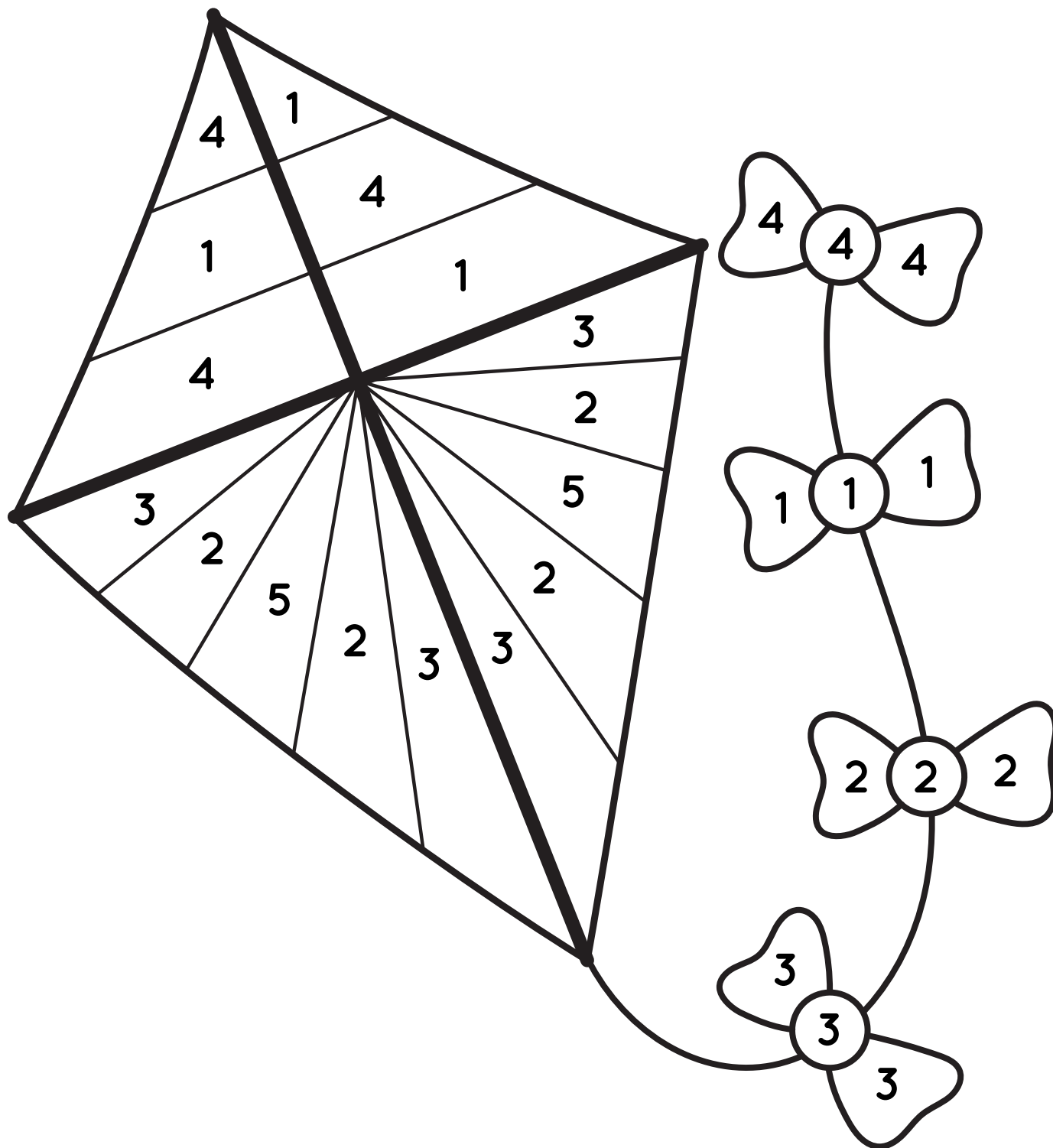

Hot cross buns!  
Hot cross buns!  
One a penny,  
two a penny,  
Hot cross buns!

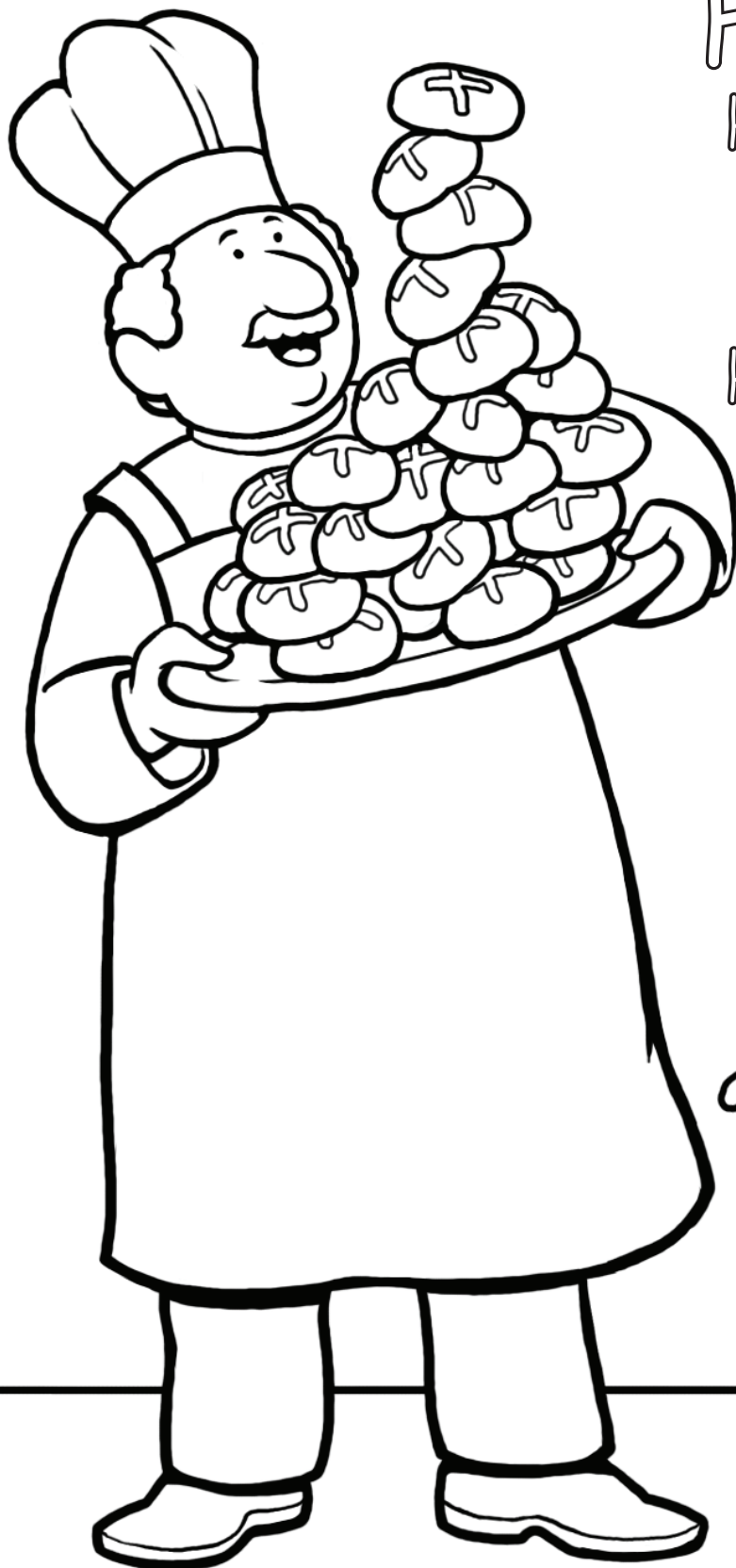

# DAY 3



## Literacy

Connect the dots in alphabetical order.

Identify all the letter T's in the poem.

Match the animal to its description.

## Math

Count the raindrops in the matching activity.

Trace and write 1-10 in number and word form.

## Fun Stuff

Sort the pictures into categories.

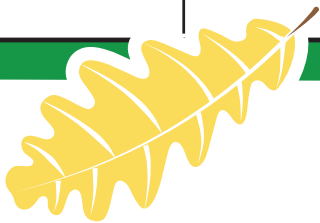

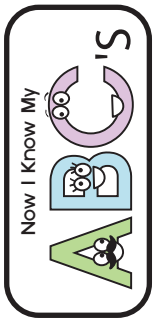

Connect the Dots with Lowercase Letters: Shark

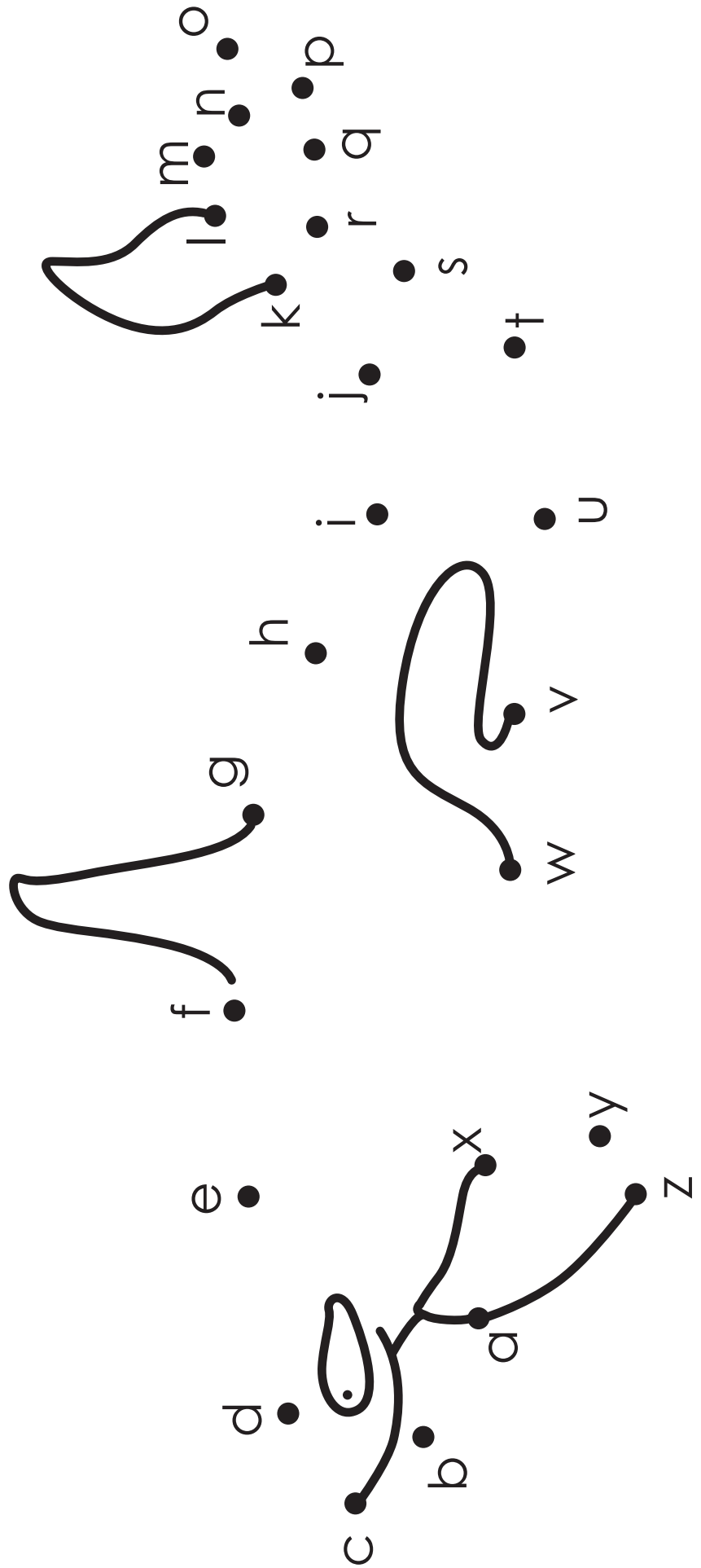
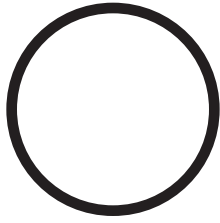



Read the poem. Circle each T that you see.



Twinkle, twinkle, little star,  
How I wonder what you are.  
Up above the world so high,  
Like a diamond in the sky.  
Twinkle, twinkle, little star,  
How I wonder what you are.

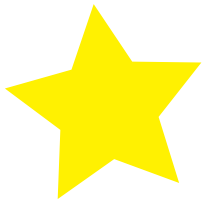

How many T's did you find?

\_\_\_\_\_

-----

\_\_\_\_\_



# Animal Roundup

Draw a line from the clue to the animal it matches.



I love to purr, nap in the sun and chase mice.



I like to eat bananas and climb trees.

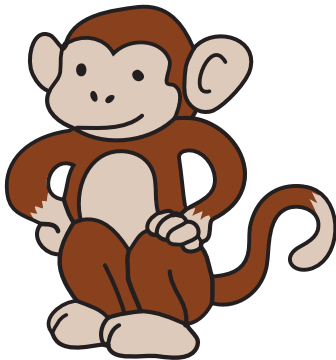

I am from Asia, and my favorite food is bamboo.

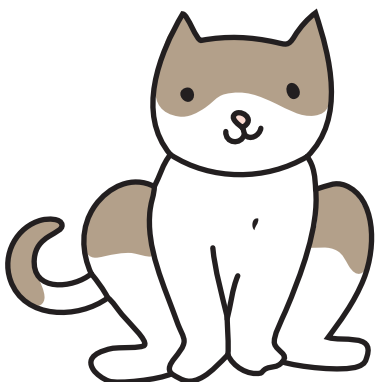

I bark and eat bones. I love to play fetch!

Name \_\_\_\_\_

Date \_\_\_\_\_

# Counting Raindrops

Color the raindrops and match the number!

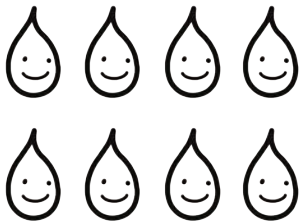

•

• 10

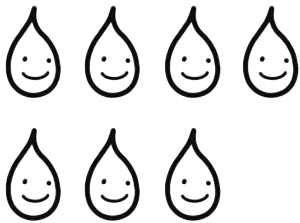

•

• 9

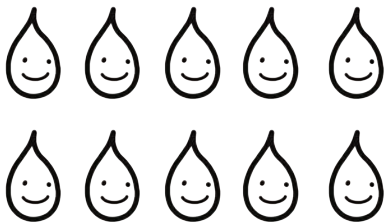

•

• 8

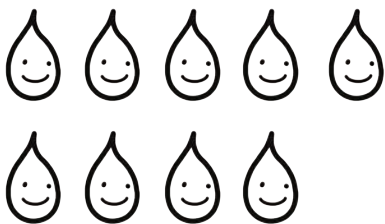

•

• 7

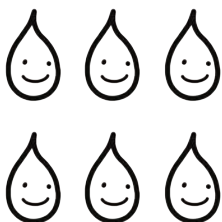

•

• 6

Name: \_\_\_\_\_

Date: \_\_\_\_\_

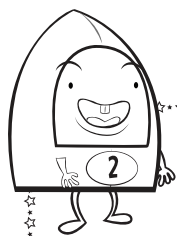

# WRITING NUMBERS MANY WAYS

Trace and write each number in a different way with a different instrument.

Trace the number in pen.

Write the number in pencil

Trace the word form in marker.

1 \_\_\_\_\_ one

6 \_\_\_\_\_ six

2 \_\_\_\_\_ two

7 \_\_\_\_\_ seven

3 \_\_\_\_\_ three

8 \_\_\_\_\_ eight

4 \_\_\_\_\_ four

9 \_\_\_\_\_ nine

5 \_\_\_\_\_ five

10 \_\_\_\_\_ ten



Name \_\_\_\_\_

Date \_\_\_\_\_

# Categorizing

Cut out the squares below. Then sort them into the correct category box.

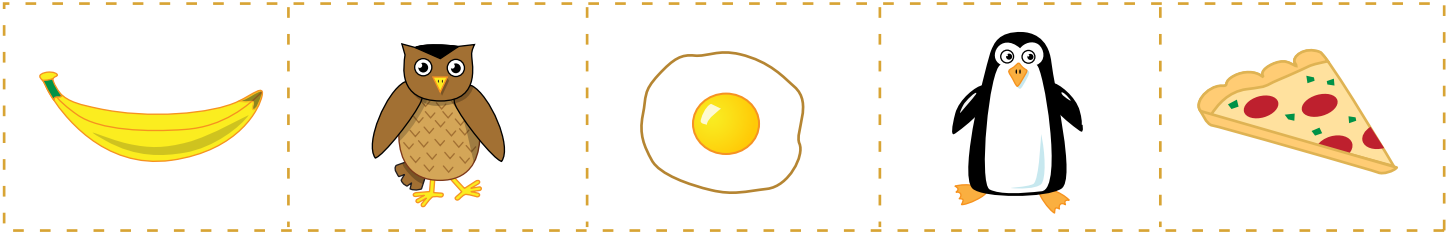
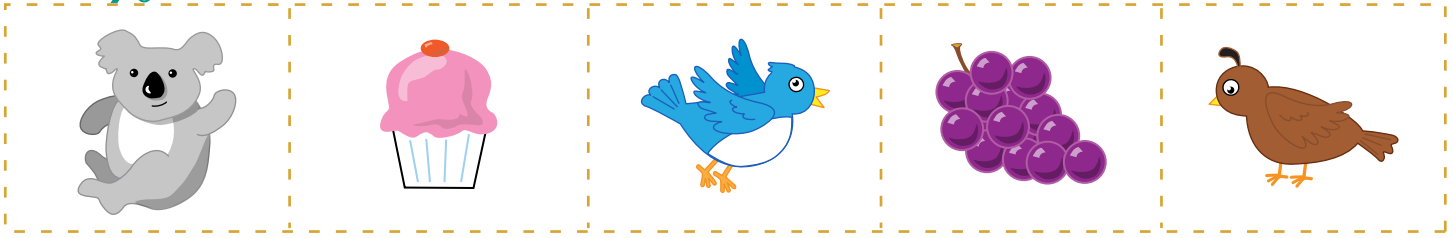

Animal	Food

# DAY 4



## Literacy

Color in the spaces to reveal a hidden picture.

Identify all the letter P's in the poem.

Make a book about the color orange!

## Math

Count the birds and tell how many beaks, wings, and feet they have.

Write the missing number on each train.

## Fun Stuff

Make a fun animal alphabet placemat!

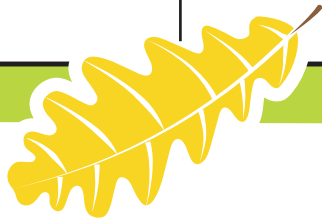

Name \_\_\_\_\_

Date \_\_\_\_\_

# HIDDEN

## IMAGE

Seashells are homes to animals that live in the ocean. Sometimes the animals leave their homes to find bigger homes. Test your letter skills and find the hidden seashells. Pick a color for each letter.

Color in each space that contains a letter.

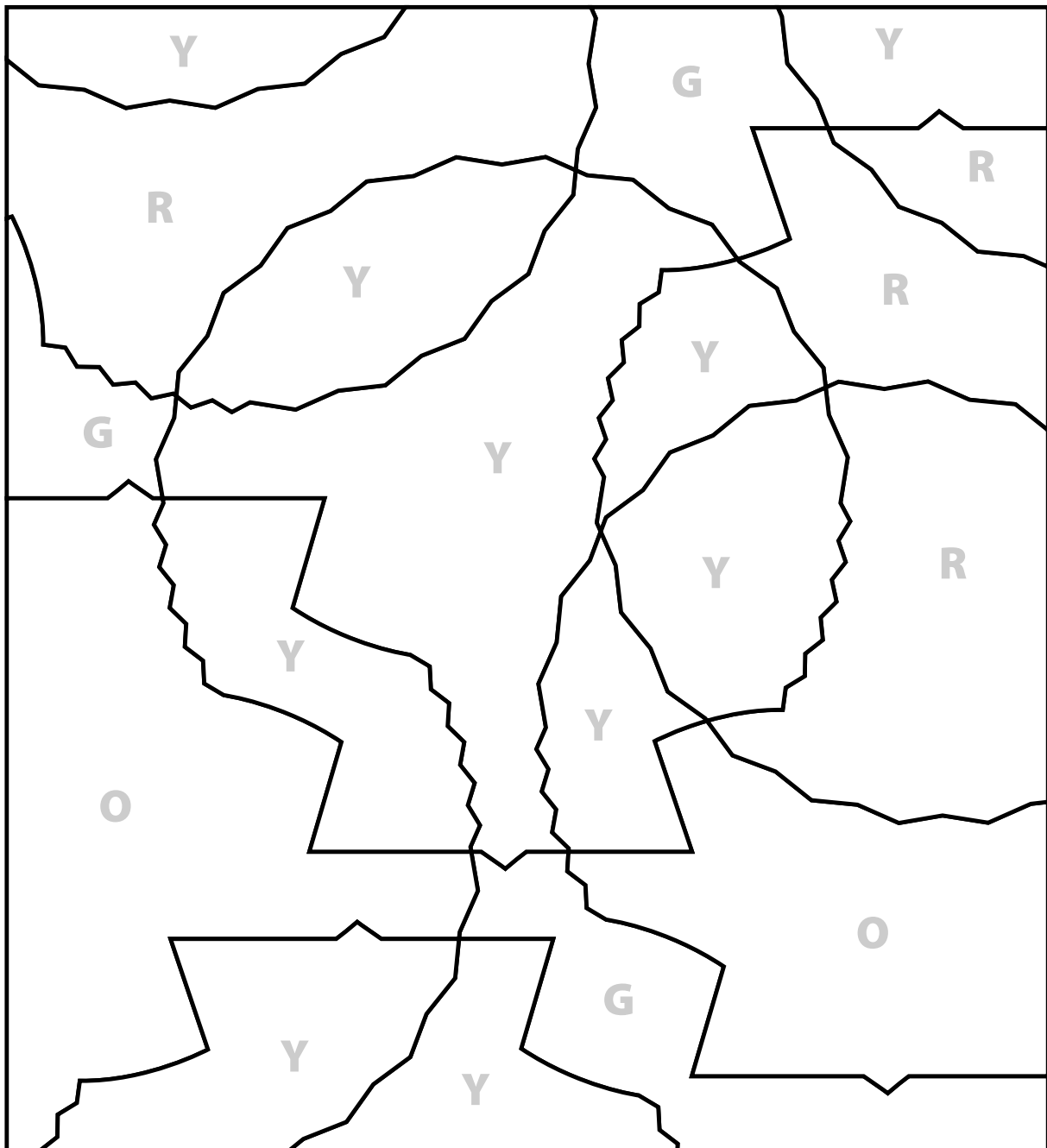

P

Read the poem. Circle each P that you see.



Peter Piper picked a  
peck of pickled peppers,  
A peck of pickled peppers  
Peter Piper picked.  
If Peter Piper picked a peck  
of pickled peppers,  
Where's the peck of pickled  
peppers Peter Piper picked?

How many P's did you find?

\_\_\_\_\_

-----

\_\_\_\_\_



\_\_\_\_\_s

Book of Orange



The carrot is orange.

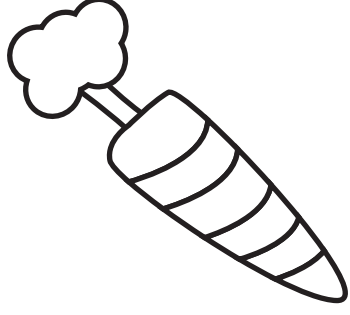

The fish is orange.

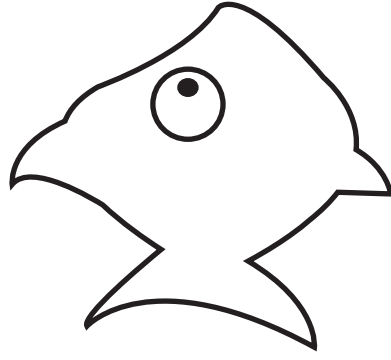

The orange is orange.

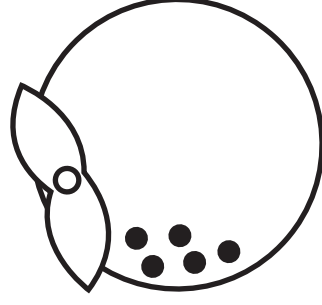

Name \_\_\_\_\_

Date \_\_\_\_\_

## COUNTING ANIMALS

# Birdy birds

Color the birds and fill in the blanks with the correct numbers.

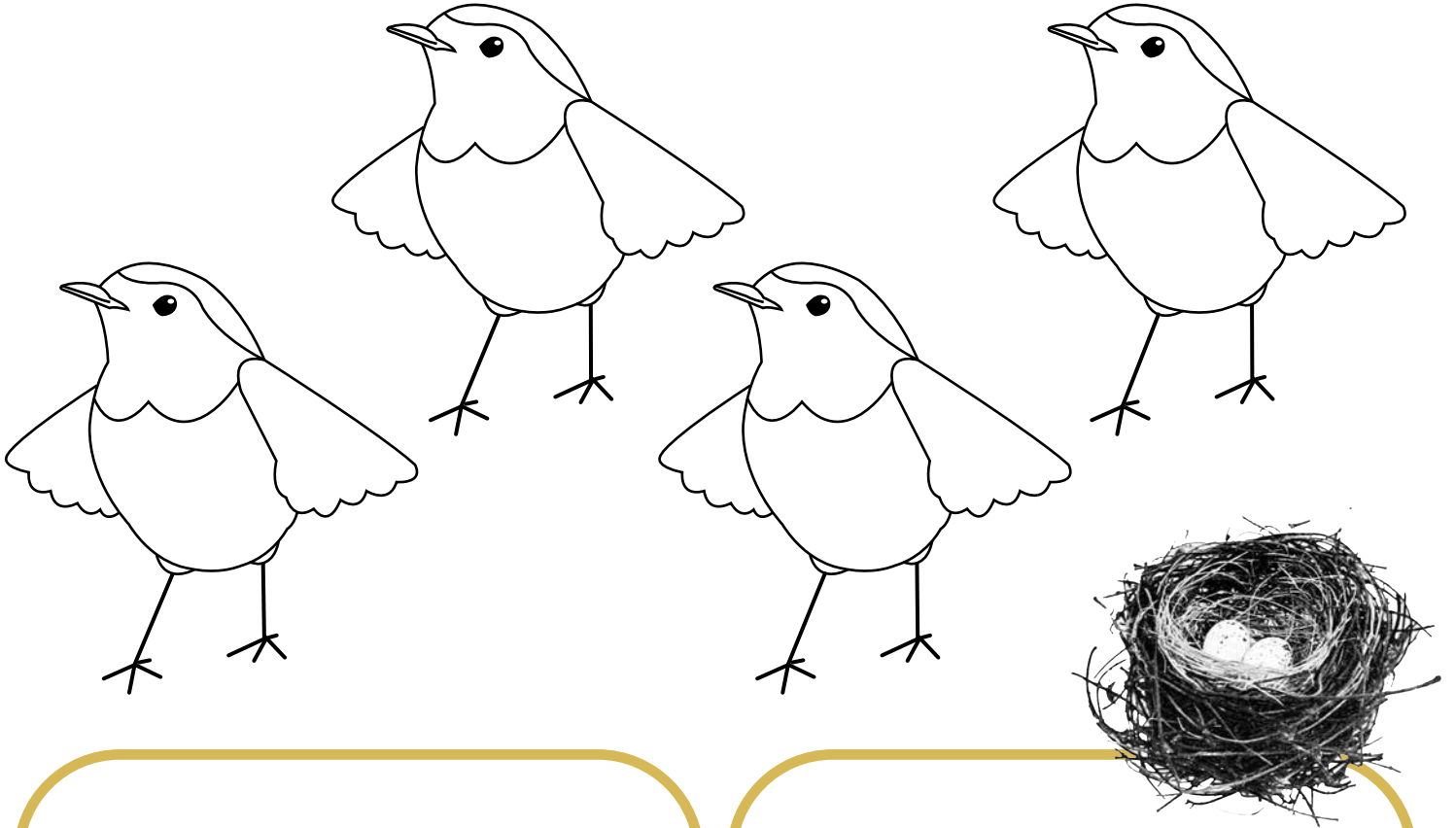

### one bird

1 bird has \_\_\_\_\_ beak.

1 bird has \_\_\_\_\_ wings.

1 bird has \_\_\_\_\_ feet.

### four birds

4 birds have \_\_\_\_\_ beaks.

4 birds have \_\_\_\_\_ wings.

4 birds have \_\_\_\_\_ feet.

# Get on Track

Can you find the missing car from each train? **Keep the numbers on each train in order!**



# Animal Alphabet Placemat



Armadillo



Bat

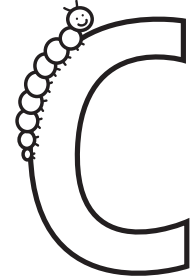

Caterpillar



Grasshopper

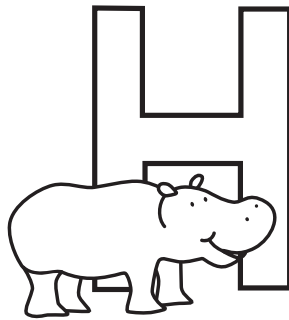

Hippopotamus

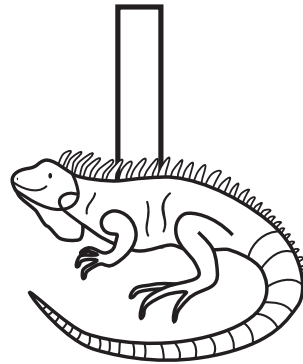

Iguana

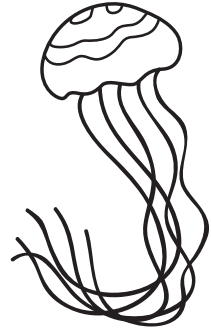

Jellyfish

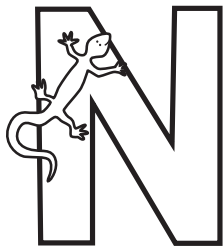

Newt

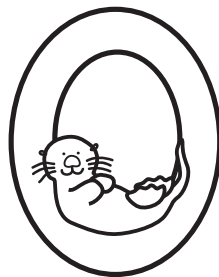

Otter

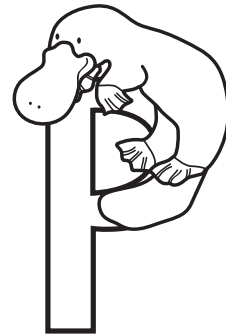

Platypus

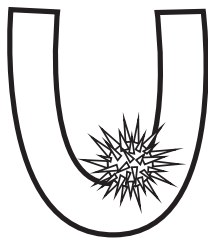

Urchin



Vulture



Walrus

Cut along the dotted line, then line up with the second page and tape or glue them together to make your placemat!



Color this placemat and practice the alphabet.

What other animals can you think of?

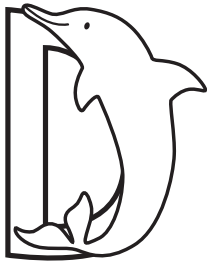

Dolphin

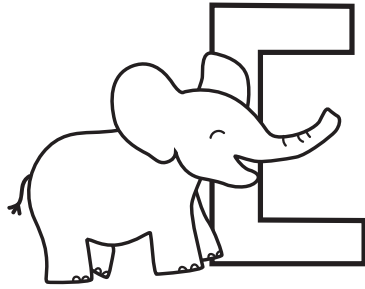

Elephant

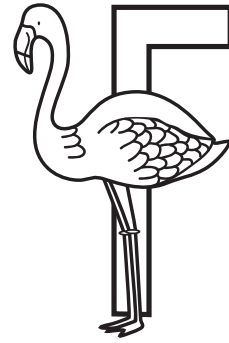

Flamingo

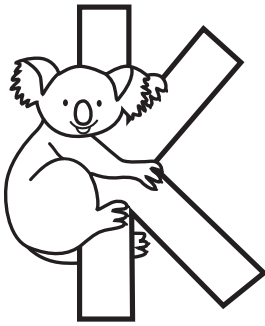

Koala

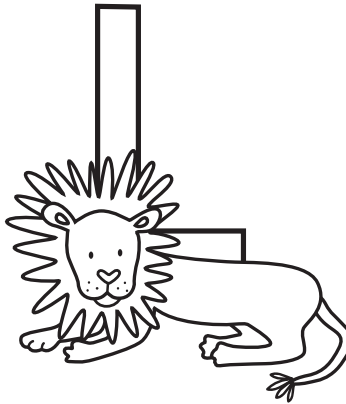

Lion

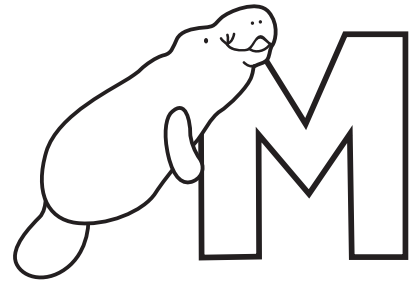

Manatee

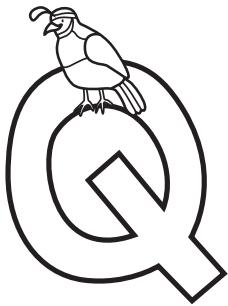

Quail

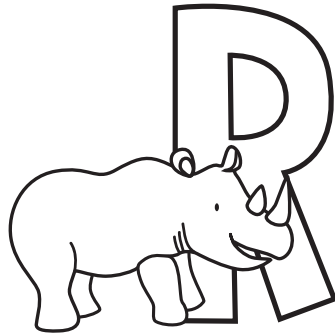

Rhinoceros



Seahorse

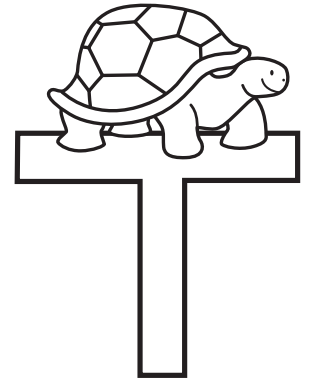

Turtle

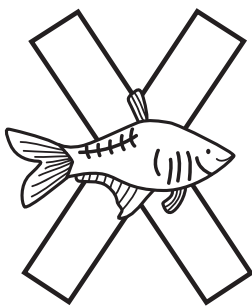

X-ray Tetra

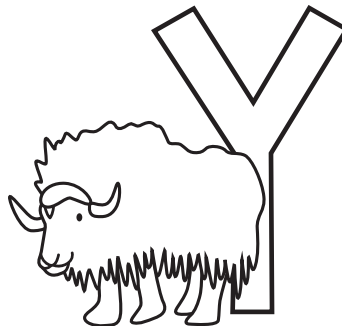

Yak

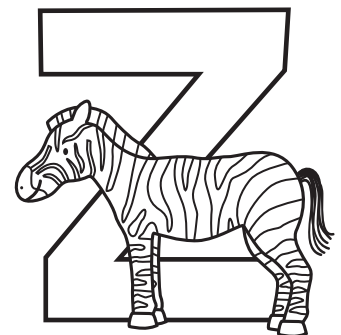

Zebra

Tape or glue first page here.

# DAY 5



## Literacy

Match the items that have the same beginning sound.

Identify all the letter O's in the poem.

Count the number of words in each sentence.

## Math

Put the numbers in order from smallest to largest.

Practice writing numbers up to 10 in the correct order.

## Fun Stuff

Color the picture and learn a trick for washing your hands.

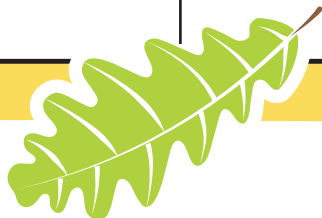

## Beginning Letter Sounds: Matching

Match the items that have the same beginning sound.

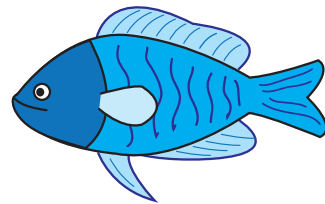
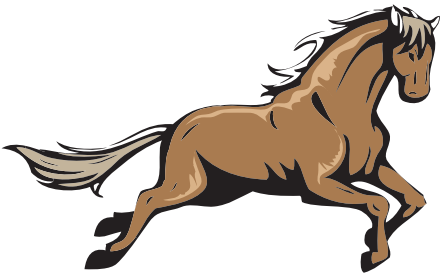
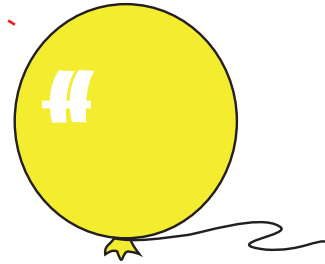
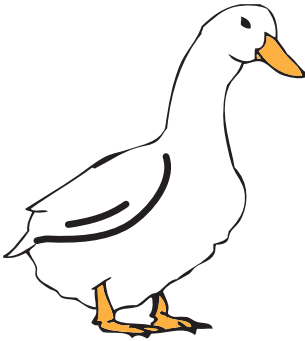
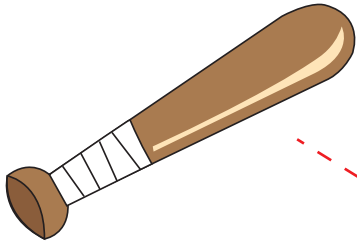

Name \_\_\_\_\_

Date \_\_\_\_\_

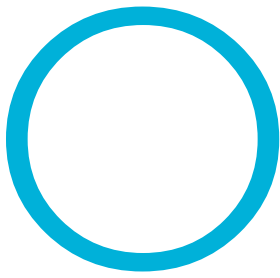

Read the poem. Circle each O that you see.



Little Boy Blue,  
come blow your horn,  
the sheep's in the meadow,  
the cow's in the corn.  
But where is the boy  
who looks after the sheep?  
He's under the haystack  
fast asleep.  
Will you wake him?  
Oh no, not I — for if I do  
he will surely cry.



How many O's did you find?

\_\_\_\_\_

-----

\_\_\_\_\_

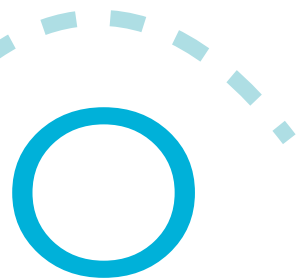

Name: \_\_\_\_\_

Date: \_\_\_\_\_

# How Many Words Are There?

First, circle each word. Then, count each circled word. Write that number on the line at the end of the sentence.

The rat is named Ben. \_\_\_\_\_

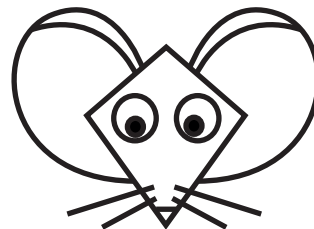

Ben is small. \_\_\_\_\_

Ben is big. \_\_\_\_\_

The black dog is named Fred. \_\_\_\_\_

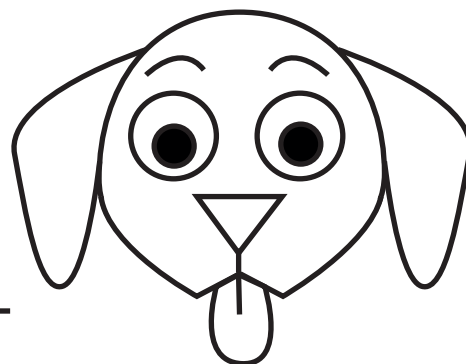

Fred is still a puppy. \_\_\_\_\_

Ben is smaller than Fred. \_\_\_\_\_

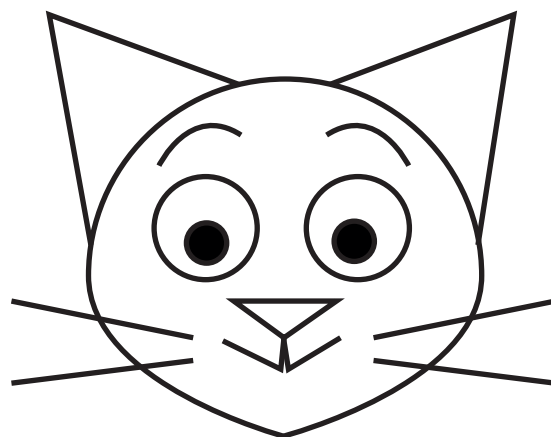









The cat's name is Catherine. \_\_\_\_\_

Catherine is the biggest. \_\_\_\_\_

# Ordering Numbers to 10

Put the numbers in order from smallest to largest.

1				

9 	2 	6 
4 	7 	3 
8 	10 	5 

# Order Em Up!

Can you put these numbers in order?

6

8

9

7

10

5

---

3

1

2

4

0

5

---

4

8

6

10

2

---

6

3

2

7

9

---

5

7

3

1

9

---

# WASH YOUR HANDS

for as long as it takes to sing the  
HAPPY BIRTHDAY song two times.

This will help you make sure  
your hands are clean.





**WEEK 1**



**FALL**  
**REVIEW PACKET**

**ANSWER**  
**KEYS**

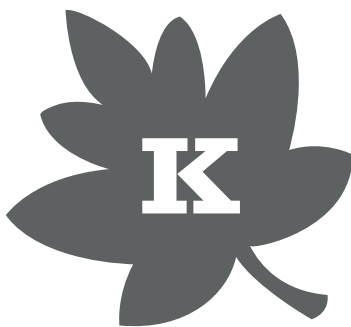

Use these answer keys  
to check your work!



Read the poem. Circle each A that you see.

What is a lassie? Lassie means girl.

### Answer Key

Did you ever see a lassie

A lassie, a lassie?

Did you ever see a lassie

Go this way and that?

Go this way and that way,

Go this way and that way.

Did you ever see a lassie

Go this way and that?



How many A's did you find?

24

# FIRST, NEXT, LAST

Cut out the pictures at the bottom of the page. Then paste them in the right order.

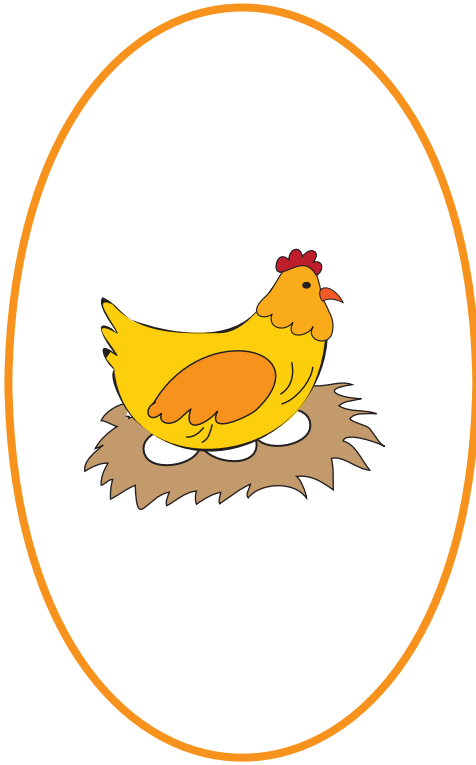

First

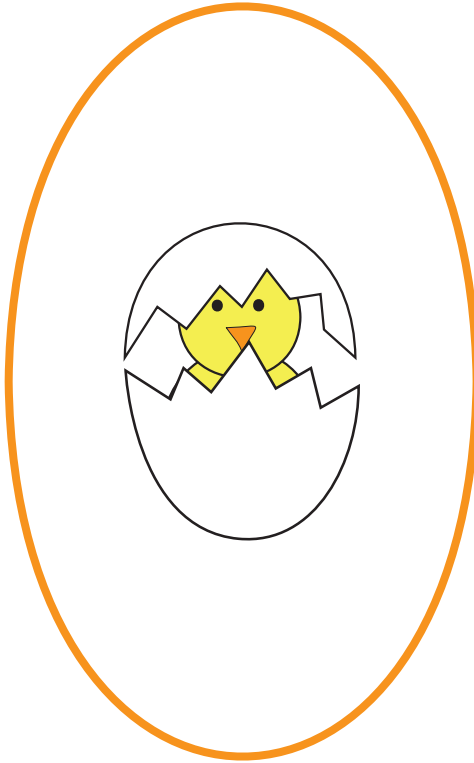

Next

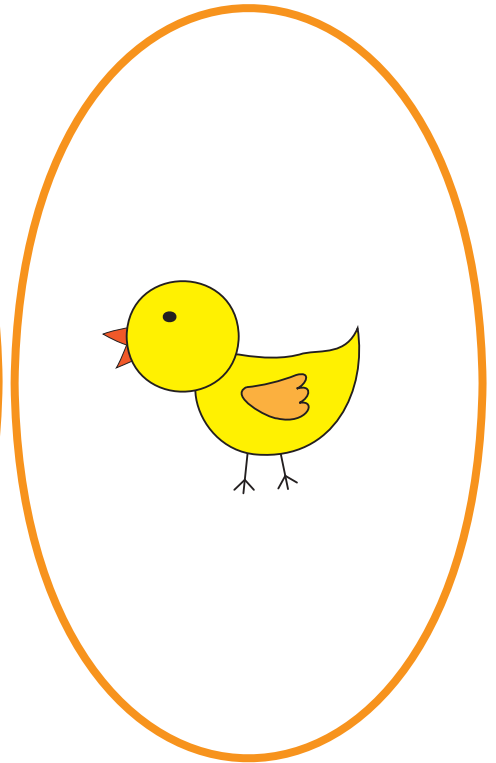



Last

# Answer Key Counting Practice: 1-10

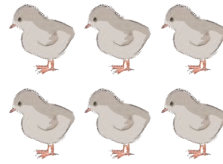
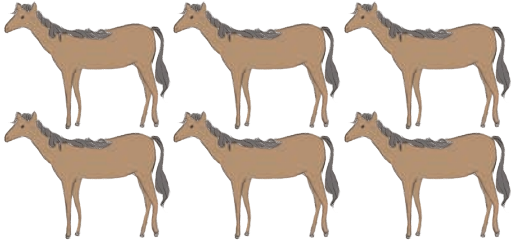

How many horses do you see? How many chicks do you see?  
Count them out loud.



The number of  is the same as the number of .

**Directions:** Count the farm animals and equipment on each card.  
Circle the cards that have the same number.

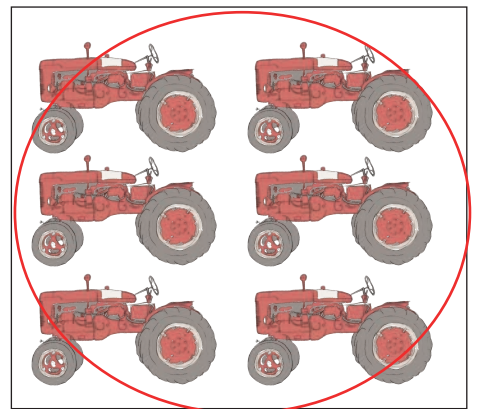
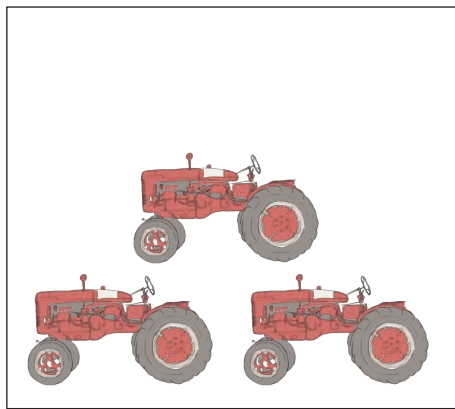
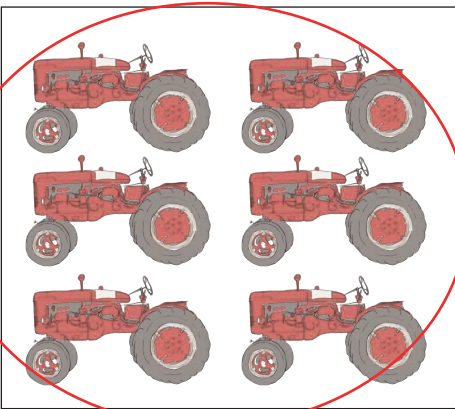
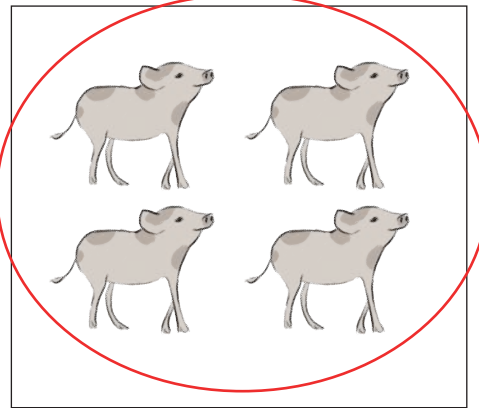
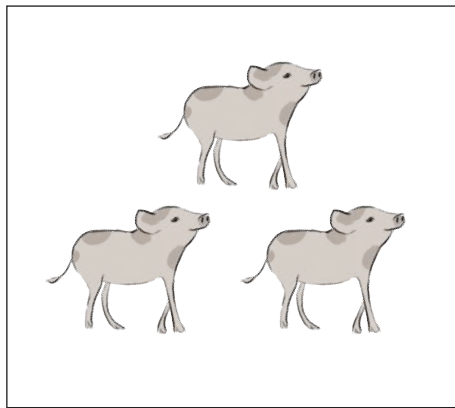
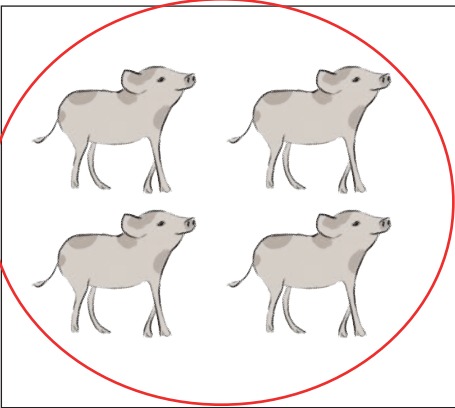

me \_\_\_\_\_

Date \_\_\_\_\_

# Answer Key Counting Practice: 1-10

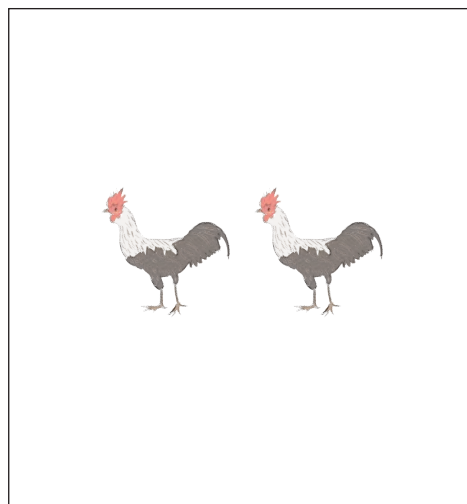
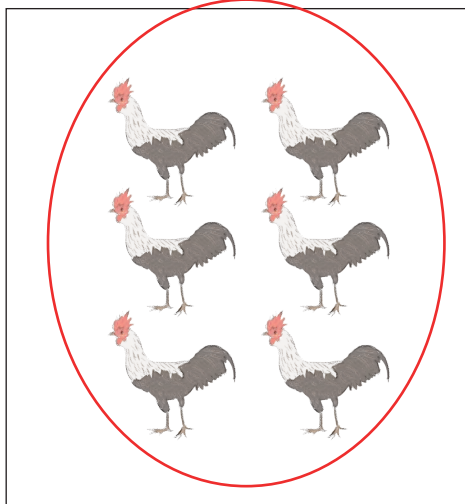
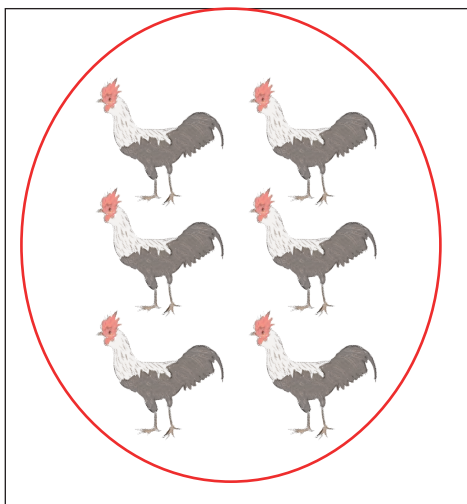
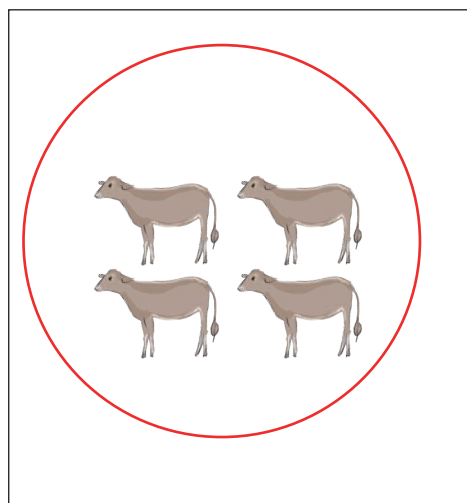
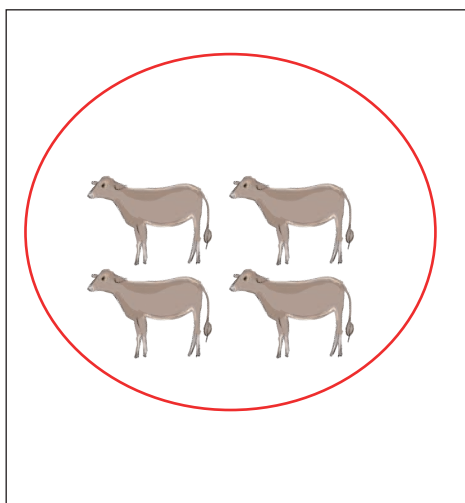
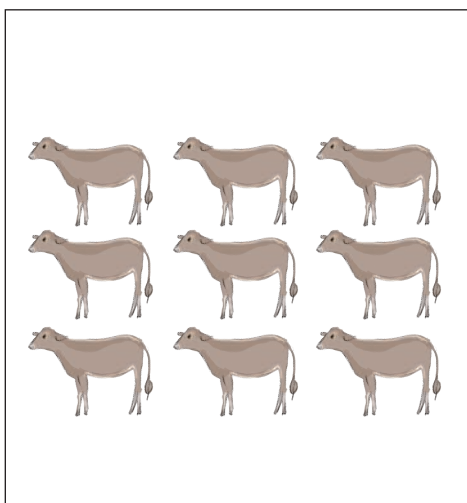
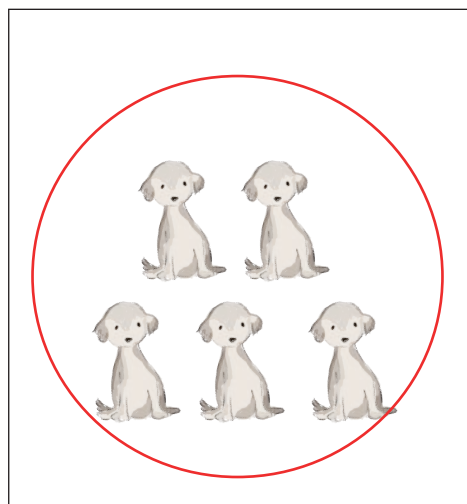
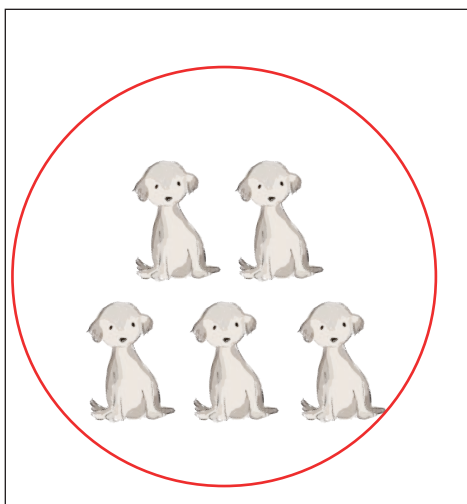

Name \_\_\_\_\_

Date \_\_\_\_\_

# Number Line Answer Key

Trace numbers 1-10.

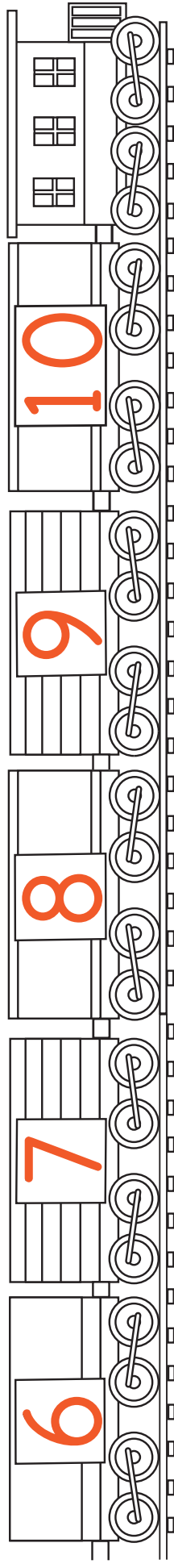
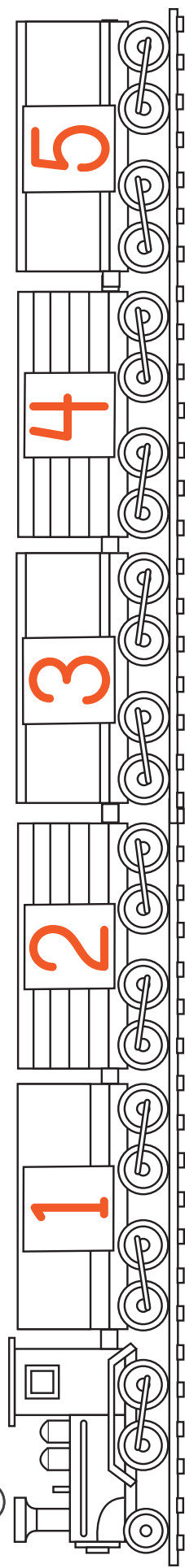

Try it yourself! Write numbers 1-10.

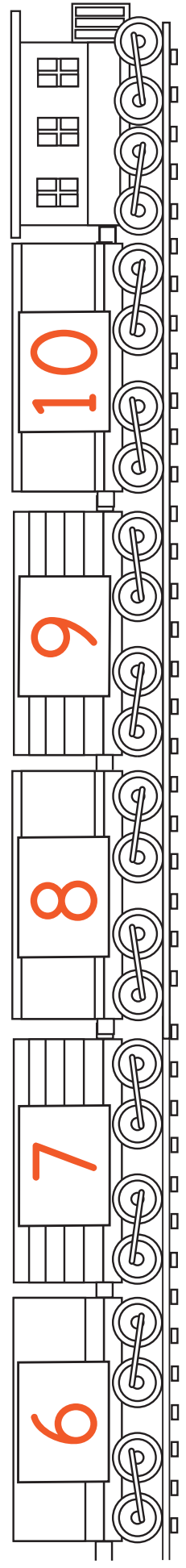
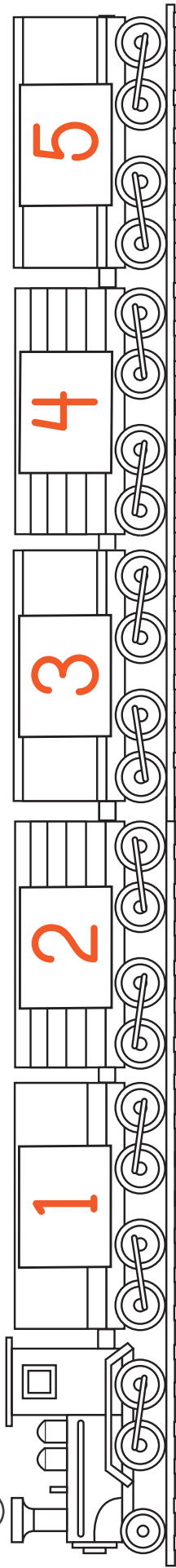

# Answer Key

Connect the Dots with Uppercase Letters: Whale

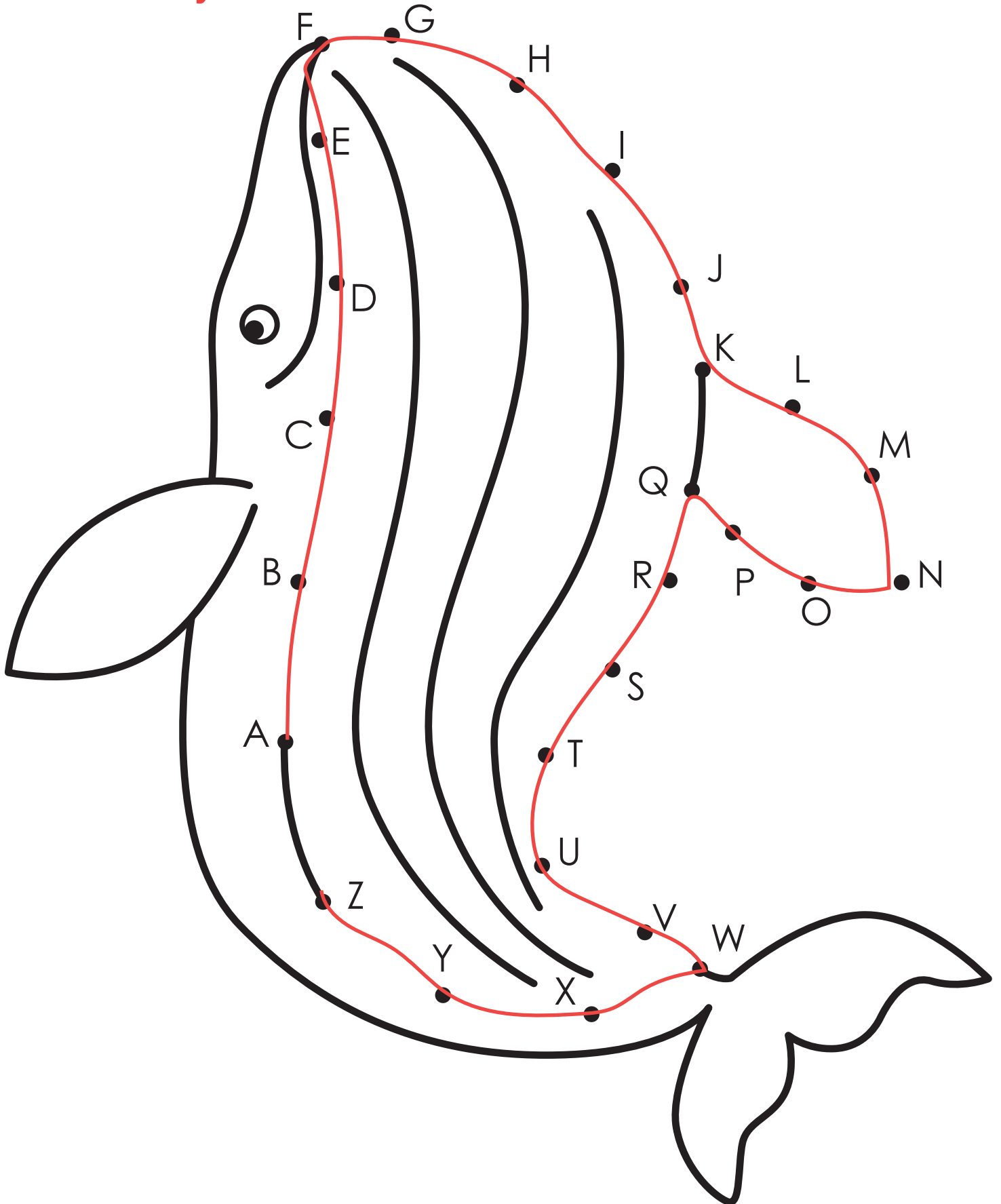



Read the poem. Circle each M that you see.

**Answer Key**

Do you know the Muffin Man,  
The Muffin Man,  
The Muffin Man?

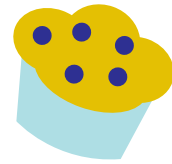

Do you know the Muffin Man  
Who lives in Drury Lane?

Yes, I know the Muffin Man,  
The Muffin Man,  
The Muffin Man.

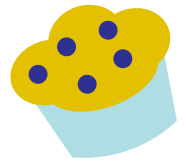

Yes, I know the Muffin Man  
Who lives in Drury Lane.

How many M's did you find?

16





# Circle the Number

Name: \_\_\_\_\_

Date: \_\_\_\_\_

Circle the number that matches the amount of objects.



4 **5** 7

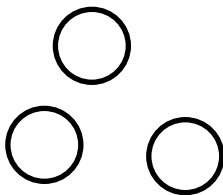

1 2 **3**

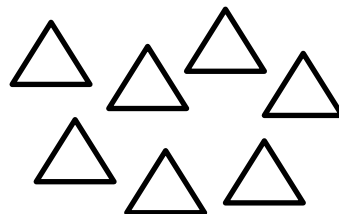

4 **7** 9

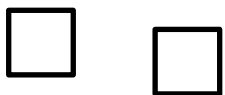

**2** 4 6

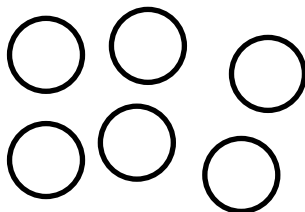

**6** 7 8



0 **1** 9

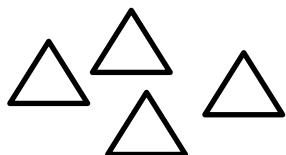

3 **4** 5

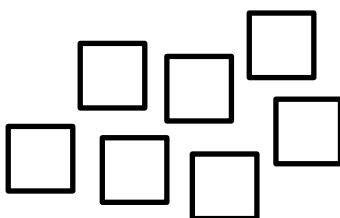

**7** 8 9

**0** 9 2

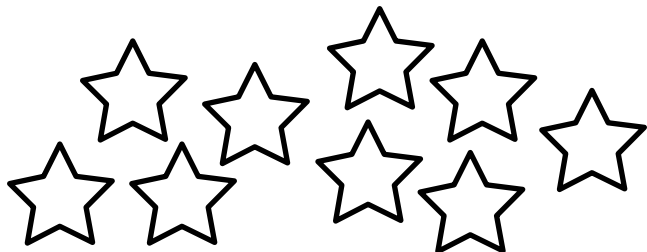

7 8 **9**

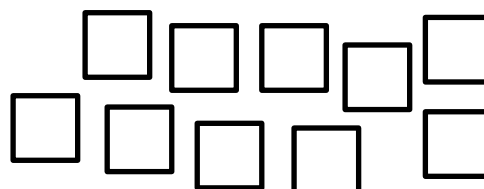

1 4 **10**

Name: Answer Key

Date: \_\_\_\_\_

## Color by Numbers: Kite

Color the kite according to the color key.

1 = Green

2 = Yellow

3 = Red

4 = Blue

5 = Purple

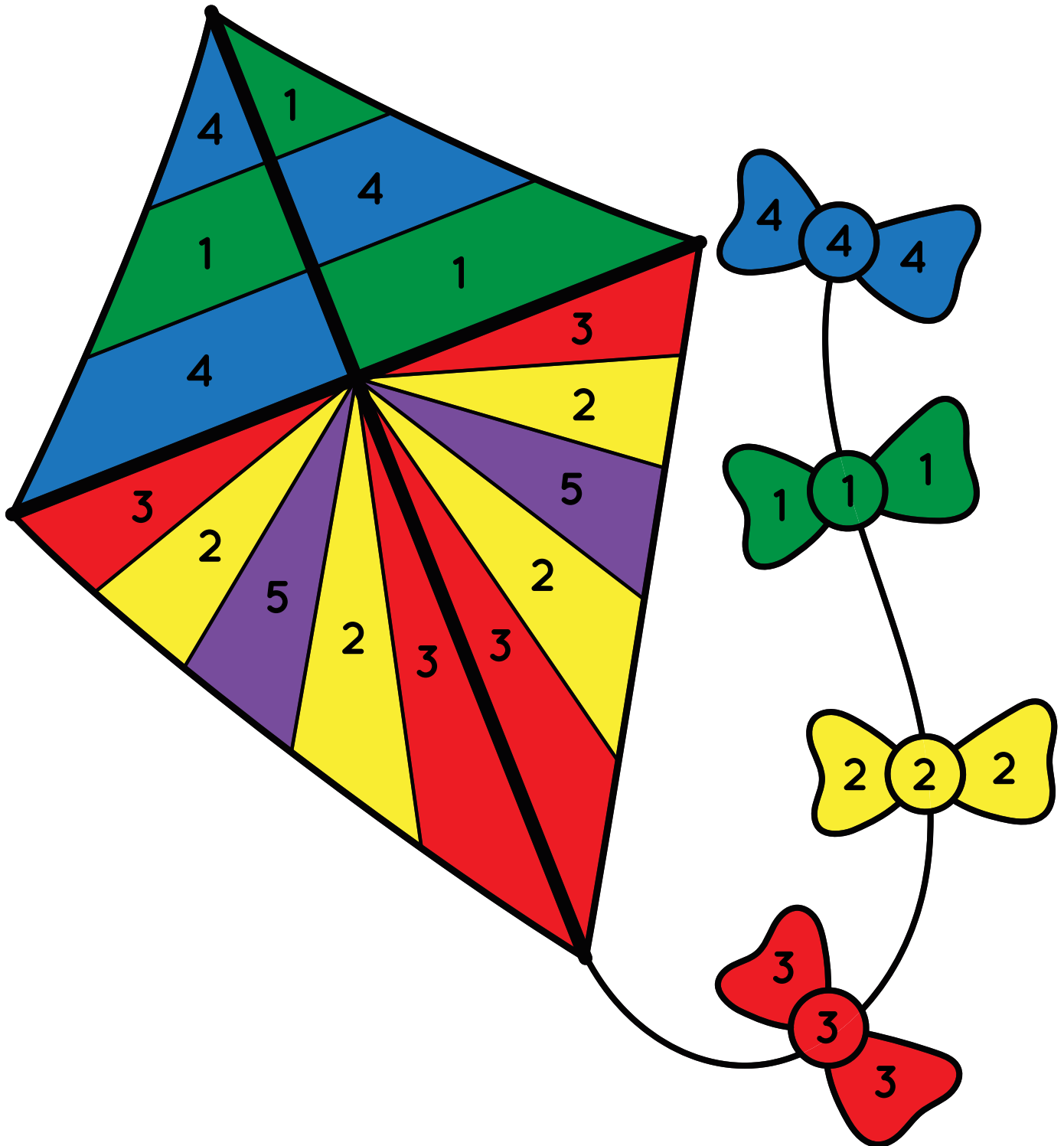

# Answer Key

Connect the Dots with Lowercase Letters: Shark

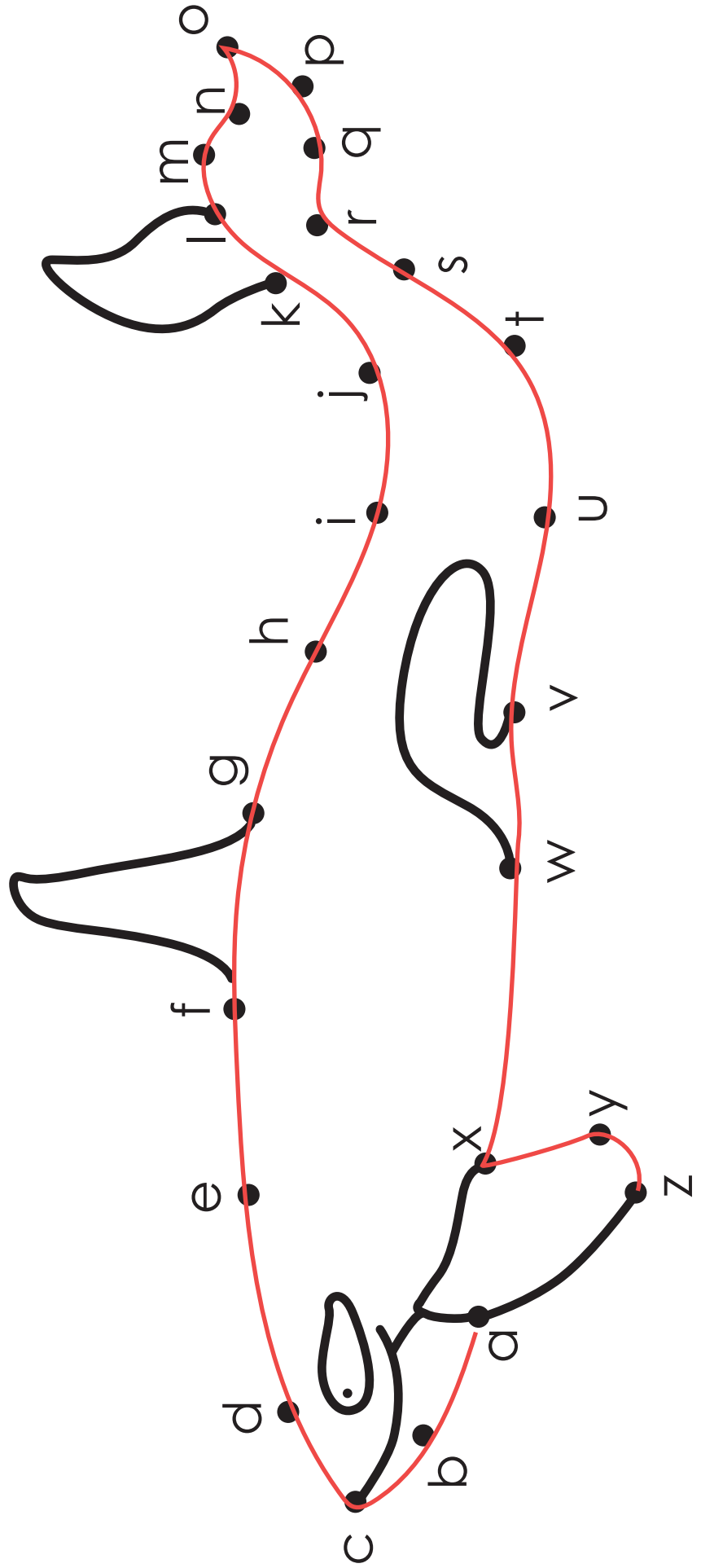
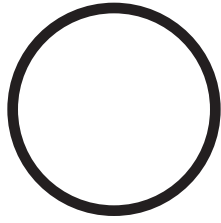



Read the poem. Circle each T that you see.

Answer Key



Twinkle, twinkle, little star,  
How I wonder what you are.  
Up above the world so high,  
Like a diamond in the sky.

Twinkle, twinkle, little star,  
How I wonder what you are.

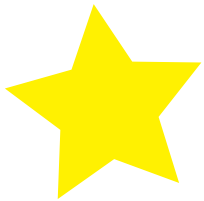

How many T's did you find?

14



# Answer Key Animal Roundup

Draw a line from the clue to the animal it matches.

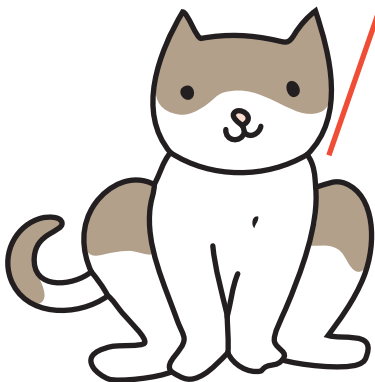
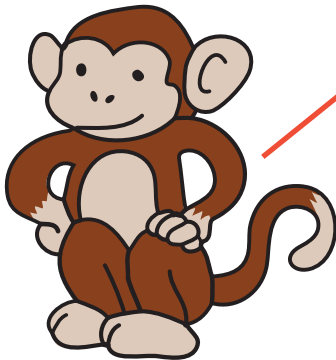
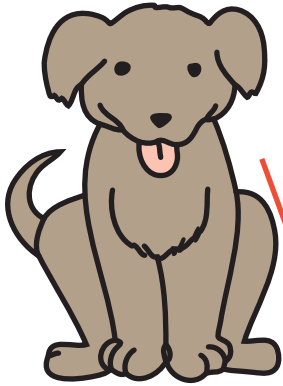

I love to purr, nap in the sun and chase mice.

I like to eat bananas and climb trees.

I am from Asia, and my favorite food is bamboo.

I bark and eat bones. I love to play fetch!

Name \_\_\_\_\_

Date \_\_\_\_\_

Answer Key

# COUNTING RAINDROPS

Color the raindrops and match the number!

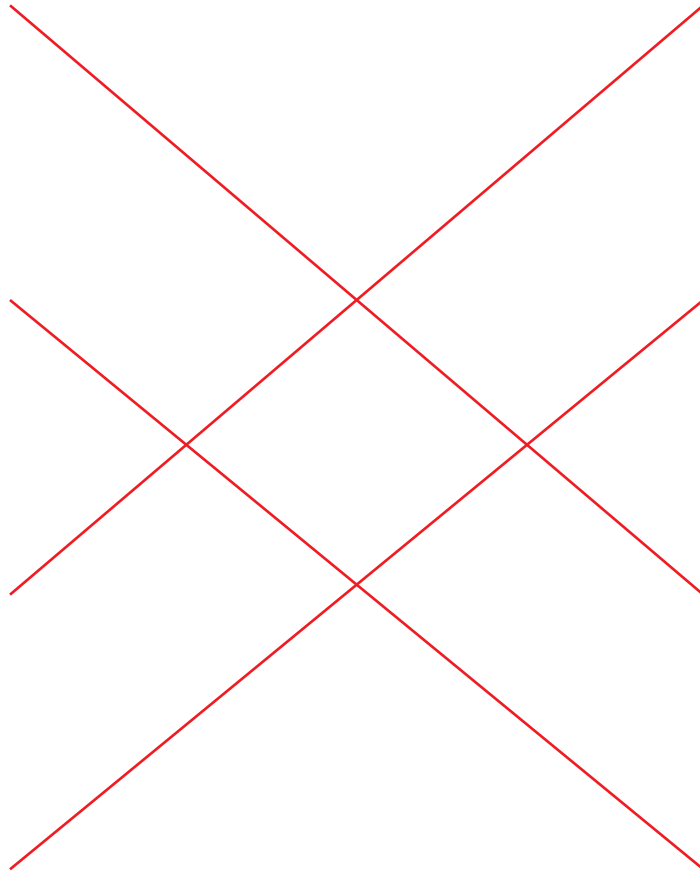
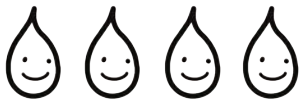
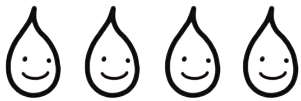
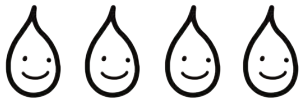
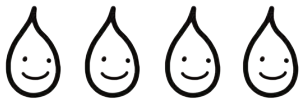

10

9

8

7

6

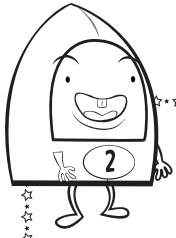

# WRITING NUMBERS MANY WAYS

Trace and write each number in a different way with a different instrument.

Trace the number in pen.

Write the number in pencil

Trace the word form in marker.

1 1 one

6 6 six

2 2 two

7 7 seven

3 3 three

8 8 eight

4 4 four

9 9 nine

5 5 five

10 10 ten

Name \_\_\_\_\_

Date \_\_\_\_\_

## Answer Key

# Categorizing

Cut out the squares below. Then sort them into the correct category box.

**Animal**

**Food**

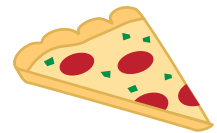
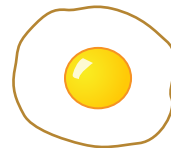
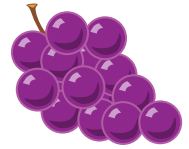
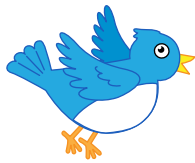



# Answer Key HIDDEN

## IMAGE

Seashells are homes to animals that live in the ocean. Sometimes the animals leave their homes to find bigger homes. Test your letter skills and find the hidden seashells. Pick a color for each letter.

Color in each space that contains a letter.

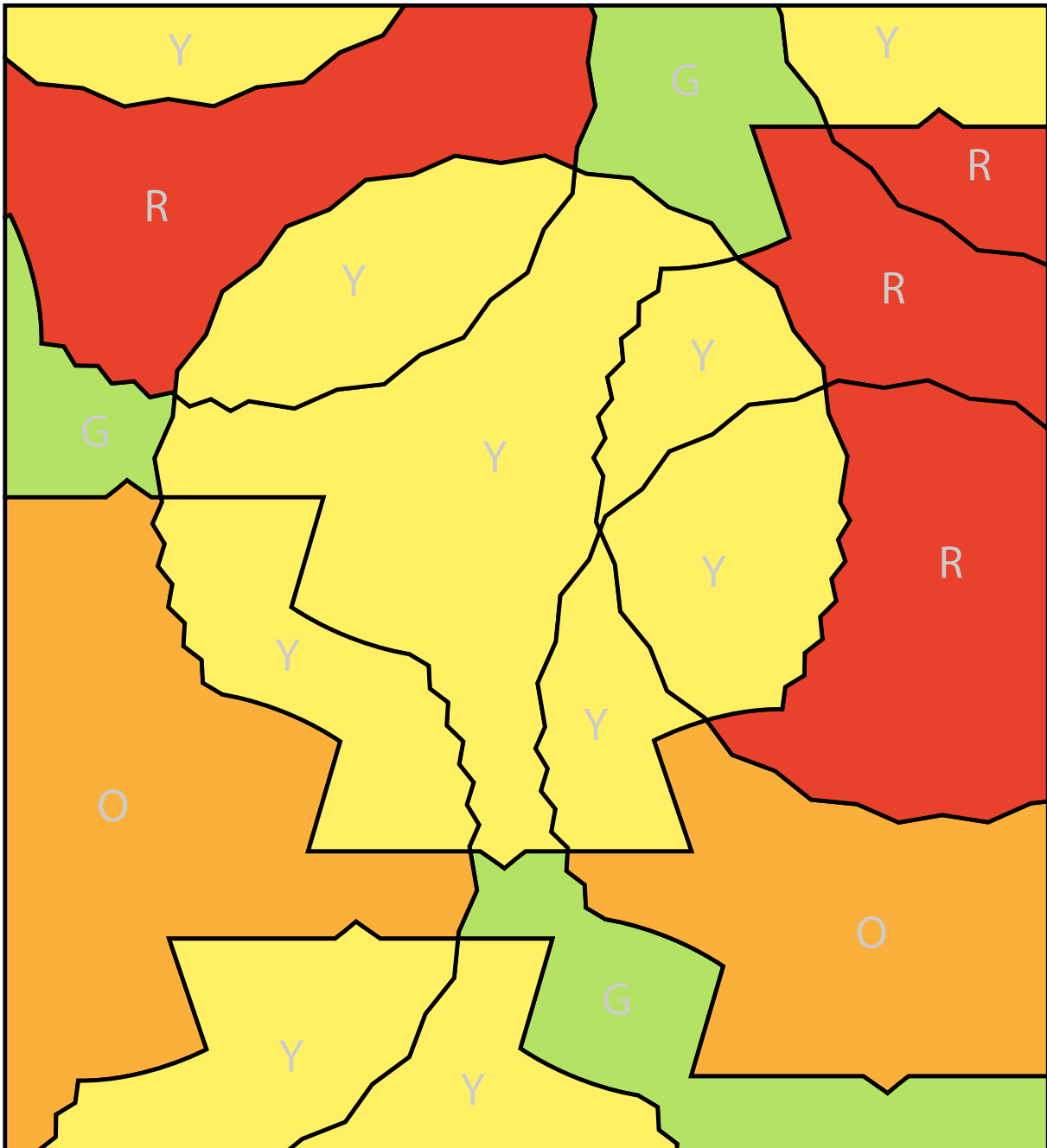

# P

Read the poem. Circle each P that you see.

## Answer Key

Peter Piper picked a  
peck of pickled peppers,  
A peck of pickled peppers  
Peter Piper picked.  
If Peter Piper picked a peck  
of pickled peppers,  
Where's the peck of pickled  
peppers Peter Piper picked?



How many P's did you find?

34



# COUNTING ANIMALS

## Birdy birds

Color the birds and fill in the blanks with the correct numbers.

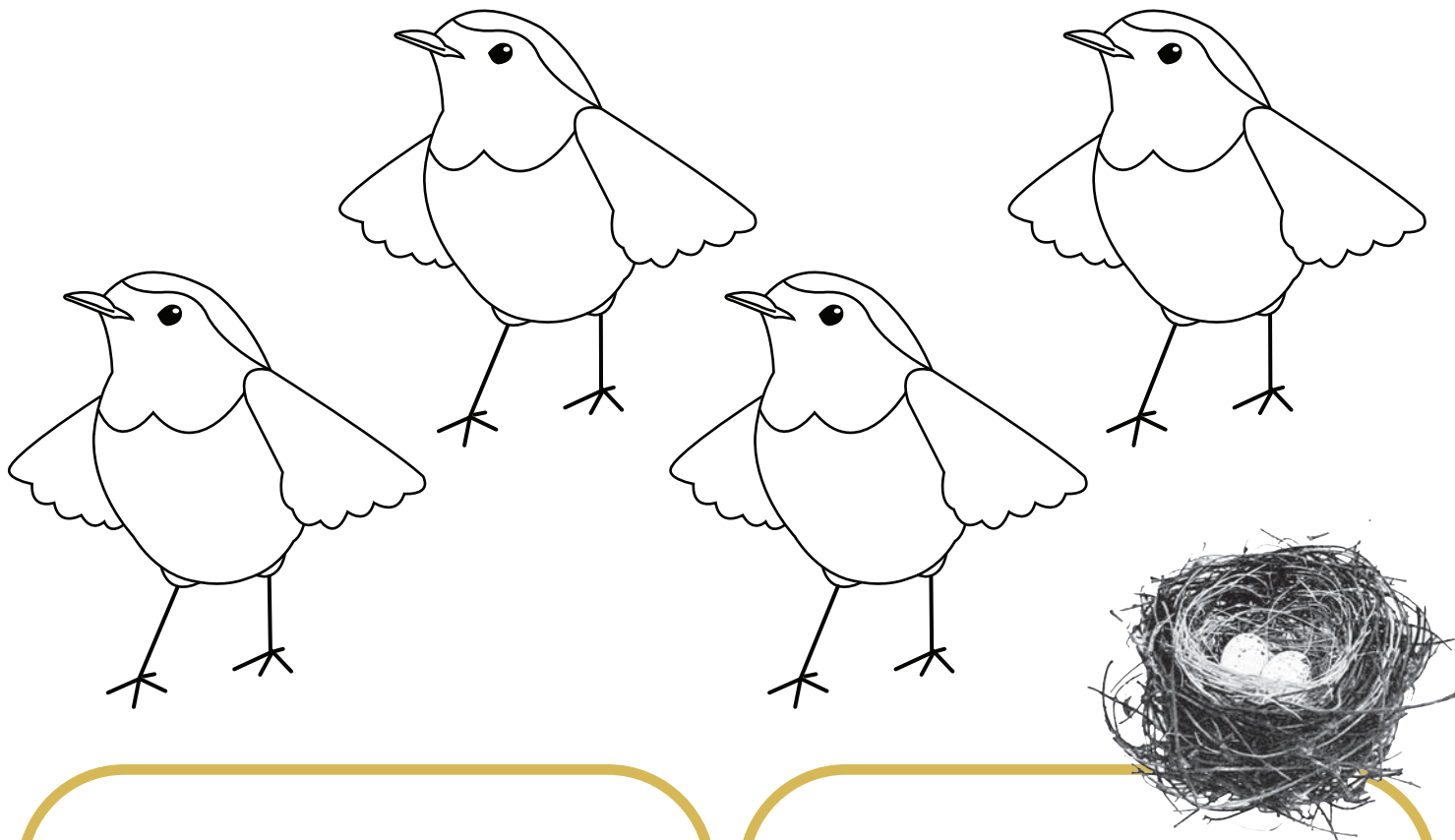

### one bird

1 bird has 1 beak.

1 bird has 2 wings.

1 bird has 2 feet.

### four birds

4 birds have 4 beaks.

4 birds have 8 wings.

4 birds have 8 feet.

Name \_\_\_\_\_

Date \_\_\_\_\_

Answer Key

# Get on Track

Can you find the missing car from each train? **Keep the numbers on each train in order!**

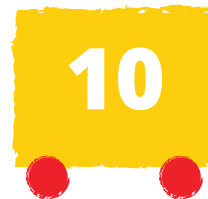

## Beginning Letter Sounds: Matching

Match the items that have the same beginning sound.

### Answer Key

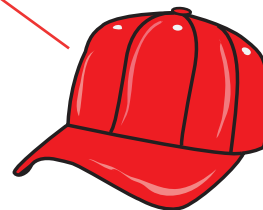
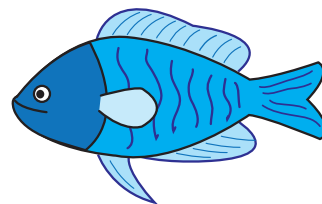
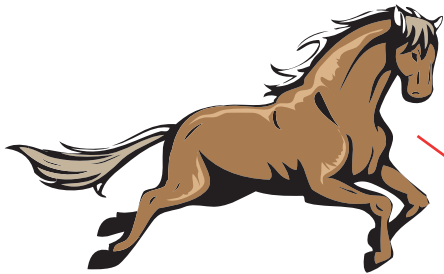
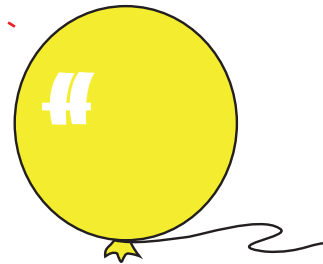
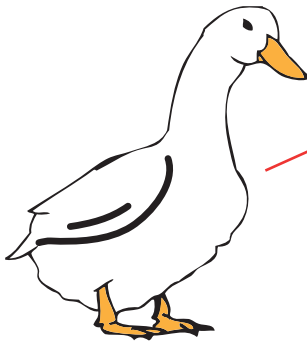
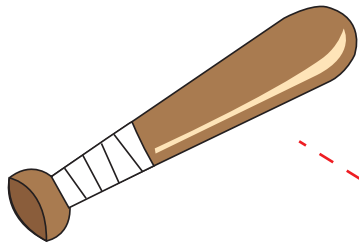

Name \_\_\_\_\_

Date \_\_\_\_\_

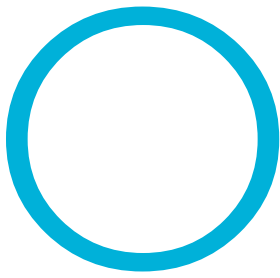

Read the poem. Circle each O that you see.

## Answer Key

Little Boy Blue,  
come blow your horn,  
the sheep's in the meadow,  
the cow's in the corn.  
But where is the boy  
who looks after the sheep?  
He's under the haystack  
fast asleep.  
Will you wake him?  
Oh no, not I — for if I do  
he will surely cry.



How many O's did you find?

17

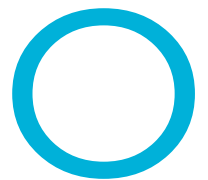

Name: Answer Key

Date: \_\_\_\_\_

# How Many Words Are There?

First, circle each word. Then, count each circled word. Write that number on the line at the end of the sentence.

The rat is named Ben. 5

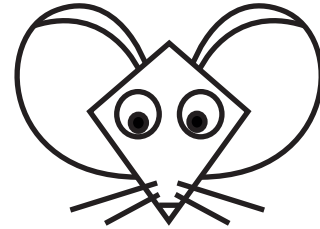

Ben is small. 3

Ben is big. 3

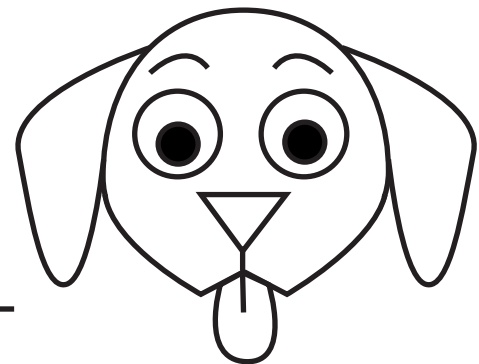

The black dog is named Fred. 6

Fred is still a puppy. 5

Ben is smaller than Fred. 5

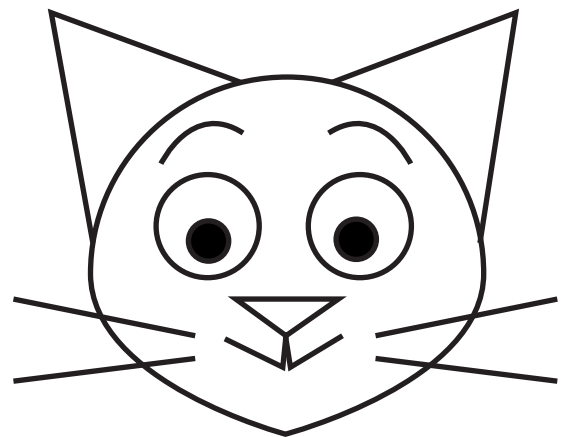

The cat's name is Catherine. 5

Catherine is the biggest. 4

Answer Key

# Ordering Numbers to 10

Put the numbers in order from smallest to largest.

1 ●	2 ●●	3 ●●●	4 ●● ●●	5 ●●● ●●
6 ●●● ●●●	7 ●●●● ●●●	8 ●●●● ●●●●	9 ●●●●● ●●●●	10 ●●●●● ●●●●●

9 ●●●●● ●●●●	2 ●●	6 ●●● ●●●
4 ●● ●●	7 ●●●● ●●●	3 ●●●
8 ●●●● ●●●●	10 ●●●●● ●●●●●	5 ●●● ●●



Answer Key

# Order Em Up!

Can you put these numbers in order?

6

8

9

7

10

5

5

6

7

8

9

10

3

1

2

4

0

5

0

1

2

3

4

5

4

8

6

10

2

2

4

6

8

10

6

3

2

7

9

2

3

6

7

9

5

7

3

1

9

1

3

5

7

9