

Community HELPERS

K
Kindergarten

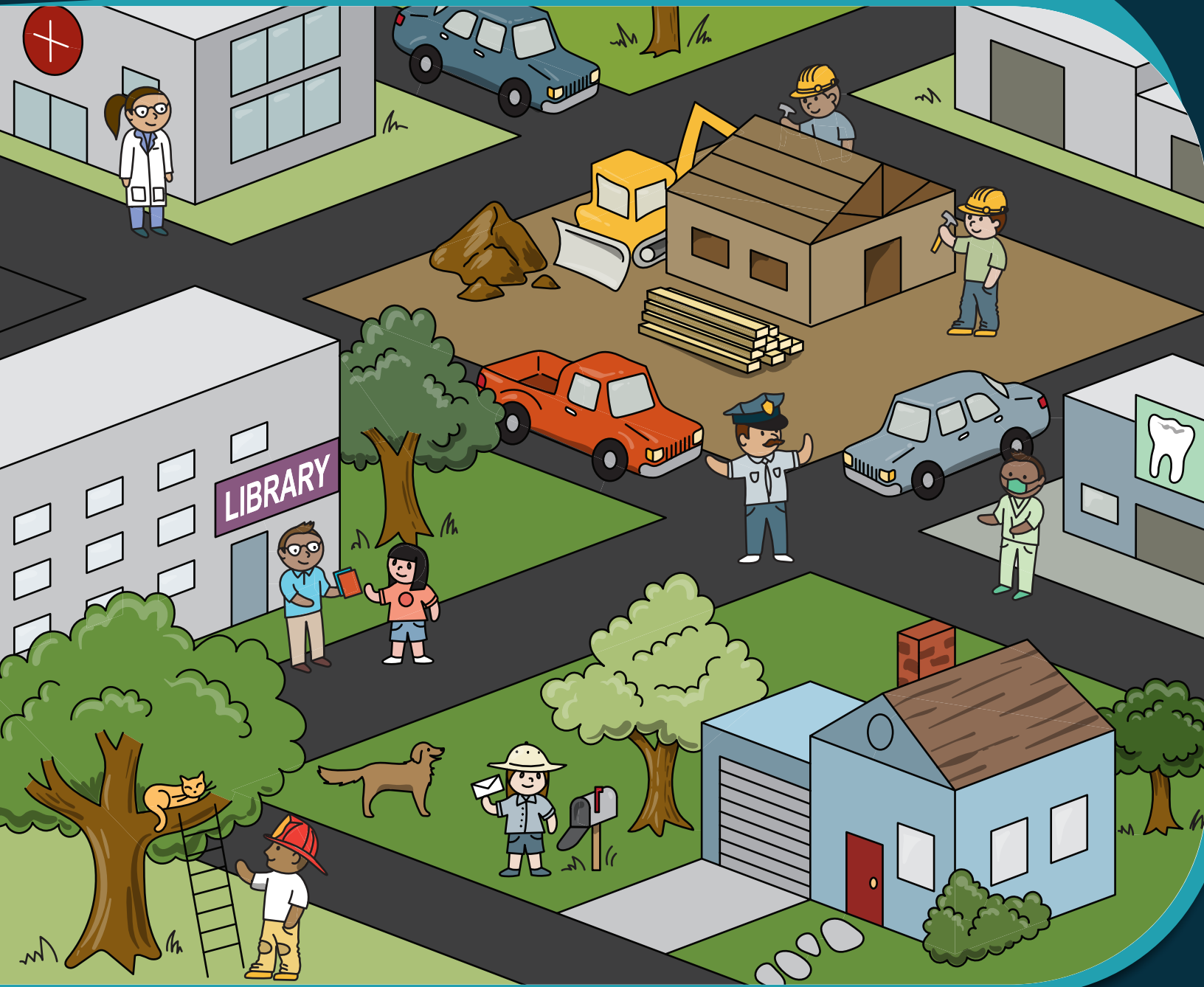

Table of Contents

Community Helpers

- Community Helpers *
- P is for Police Officer *
- F is for Firefighter *
- D is for Doctor *
- M is for Mail Carrier *
- B is for Builder *
- Community Vehicles *
- Which of These Things Is Not Like the Other? (Part One) *
- Which of These Things Is Not Like the Other? (Part Two) *
- Tools of Trade *
- Match the Tools *
- Community Helpers Word Search *
- Who Are Your Community Helpers?
- Community Helpers: Who's Who? *
- Community Helper Hunt *
- Community Helper Paper Doll
- Certificate of Completion
- Answer Sheets

** Includes Answer Sheet*

Name: _____

Date: _____

Community Helpers

Circle the people whose job is to care for others.

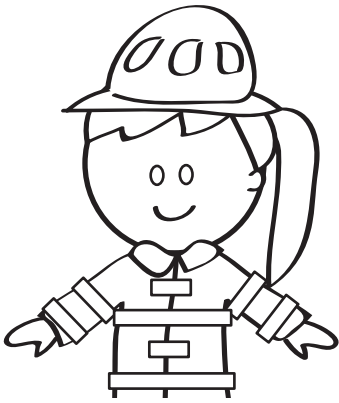

Firefighter

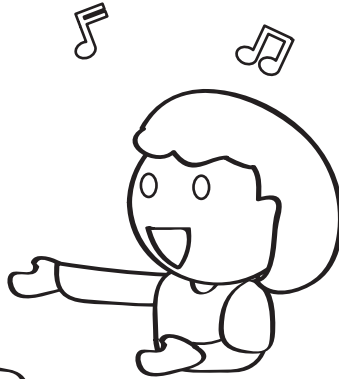

Singer

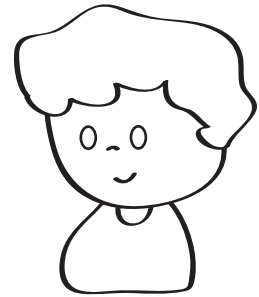

Teacher



Scientist

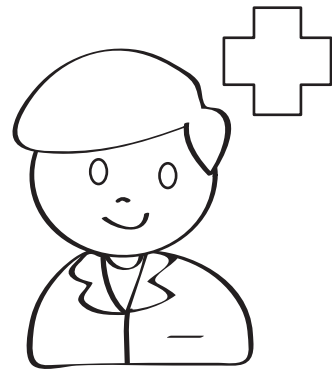

Doctor



Police Officer

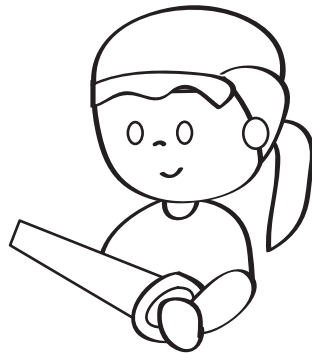

Carpenter

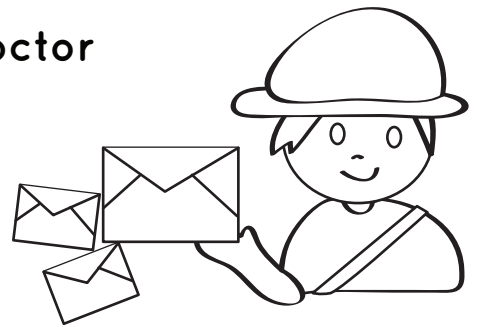

Postman

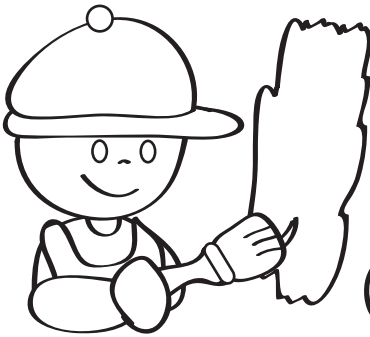

Painter



Babysitter



Nurse

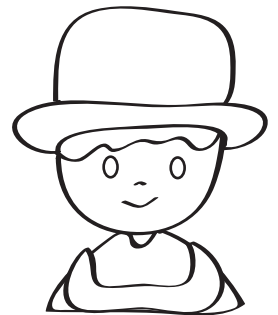

Farmer

Name: _____

Date: _____

P is for Police Officer

Police officers patrol the streets to keep us safe. They also help to direct traffic and help people when in need. Police officers wear a special uniform and carry special things that tell us who they are.

Directions: Color in all of the objects that a police officer uses in the line of duty. Then label each one with the correct name using the word bank at the bottom of the page.



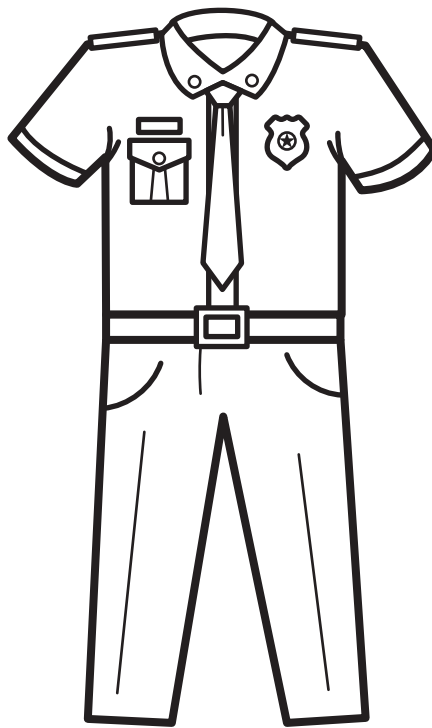

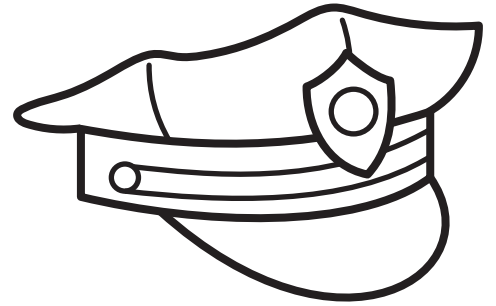

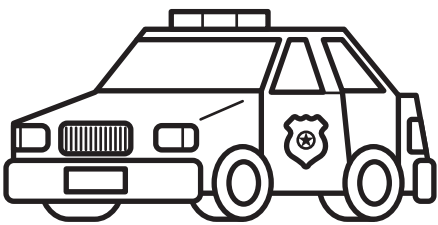

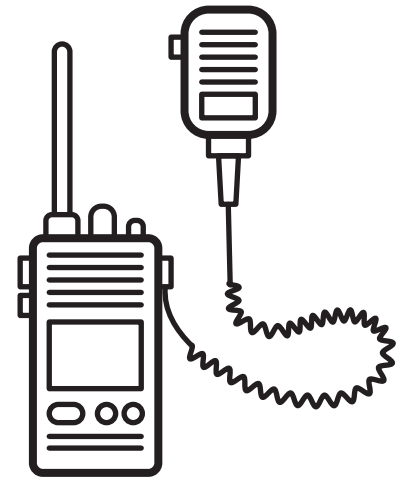

police car badge radio
police hat uniform

Name: _____

Date: _____

F is for Firefighter

Firefighters have a very dangerous job! Firefighters rescue people in danger and put out fires, but they also teach us about fire prevention and how to stay safe.

Directions: Color in all of the objects that a firefighter uses in the line of duty. Then label each one with the correct name using the word bank at the bottom of the page.

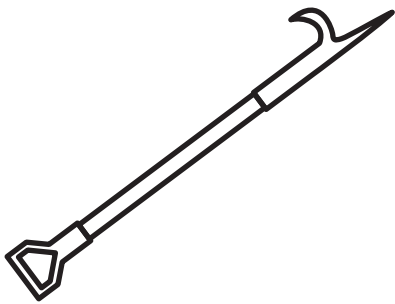





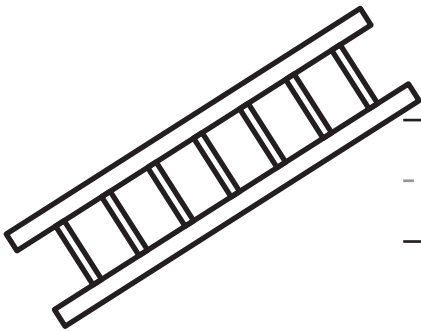

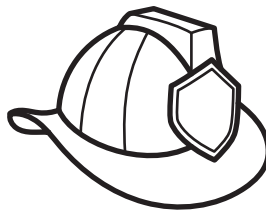

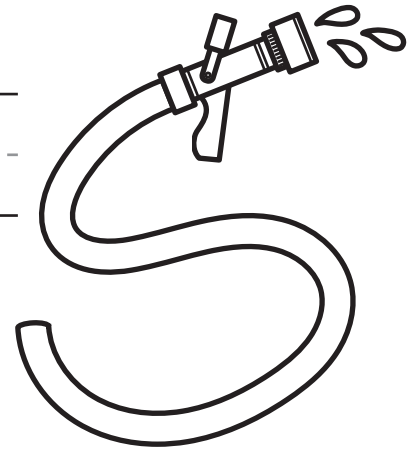

helmet

fire-proof suit

hose

ladder

hook

boots

Name: _____

Date: _____

D is for Doctor

Doctors have a very important job! They take care of us when we are sick and help to make us healthy by giving us medicine, taking our temperatures, and bandaging our wounds. You can visit a doctor in an office or in the hospital.

Directions: Color in all of the objects that a doctor uses to help keep us healthy. Then label each one with the correct name using the word bank at the bottom of the page.

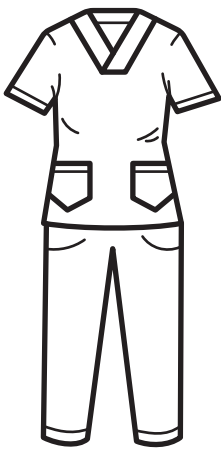

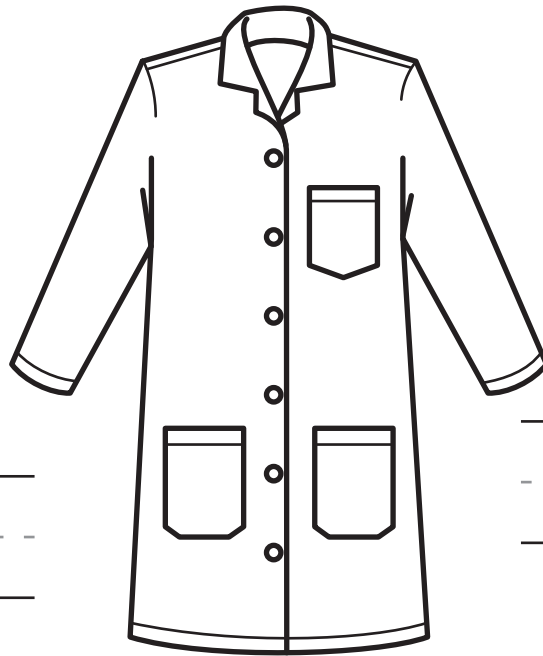



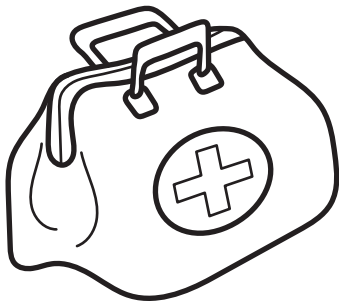

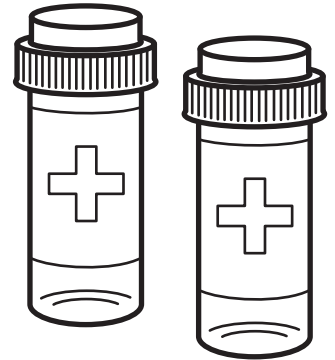

scrubs lab coat stethoscope
medicine medical bag

Name: _____

Date: _____

M is for Mail Carrier

Mail carriers have a very important job! They deliver letters and packages to us each day. Mail carriers sometimes drive mail trucks and sometimes walk from house to house to deliver the mail.

Directions: Color in all of the objects that a mail carrier might use to deliver the mail. Then label each one with the correct name using the word bank at the bottom of the page.

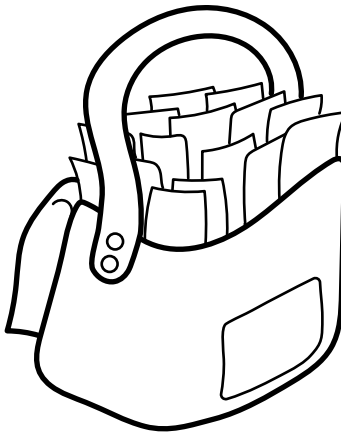
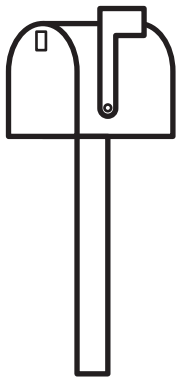

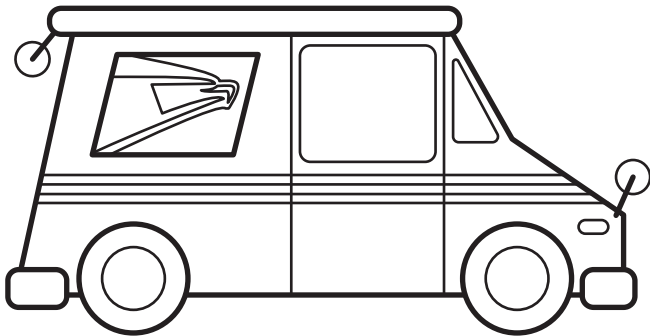

mail truck mail bag letters
stamps mailbox

Name: _____

Date: _____

B is for Builder

Builders and construction workers have a very important job! They help to build things in our community like roads, bridges, skyscrapers, and houses. Builders use big machines like diggers and bulldozers to get the job done. They wear hard hats to keep them safe on the job!

Directions: Color in all of the objects that a builder might use when they are working in the community. Then label each one with the correct name using the word bank at the bottom of the page.

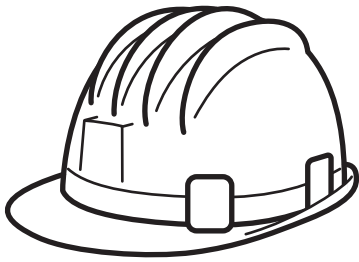

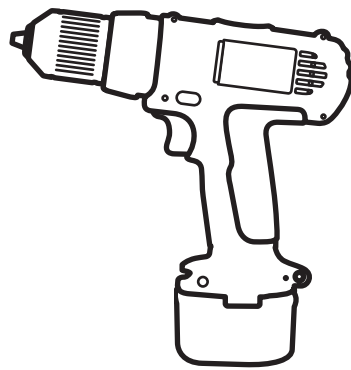

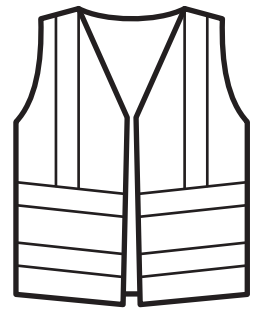



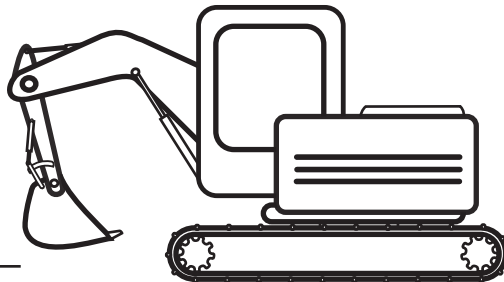

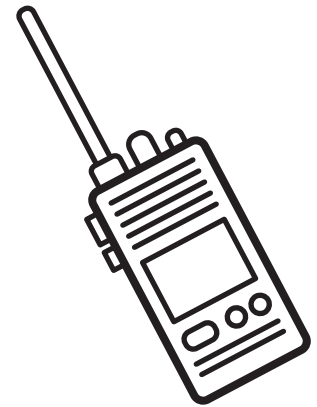

hard hat digger walkie-talkie boots
safety vest drill

Name: _____

Date: _____

Community Vehicles

Draw a line through the maze connecting the community workers with their vehicles.



Name: _____

Date: _____

Which Of These Things Is Not Like the Other?

In each row, circle the thing that does not go with the first picture.

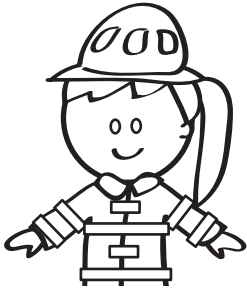

Firefighter

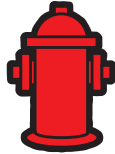

Hydrant



Spoon



Fire Truck

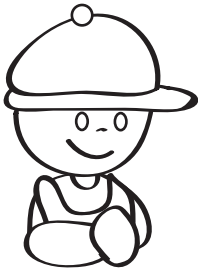

Builder



Juice



Hammer



House

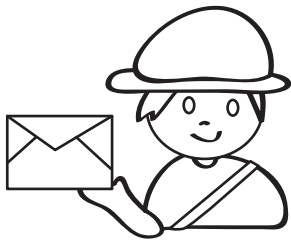

Mail Carrier

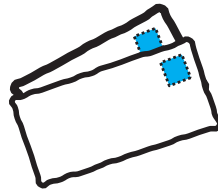

Letters



Ice Cream

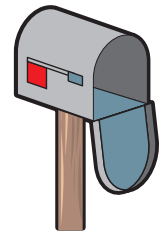

Mail Box

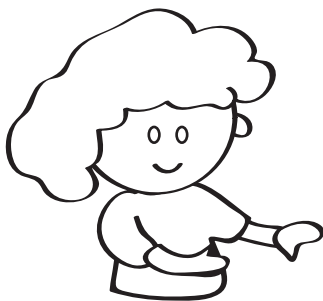

Grocer



Money

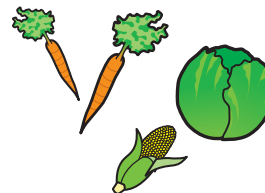

Vegetables

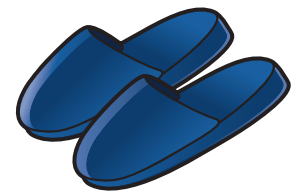

Slippers

Name: _____

Date: _____

Which Of These Things Is Not Like the Other? PART 2!

In each row, circle the thing that does not go with the first picture.



Librarian



Books



Basketball



Library Card

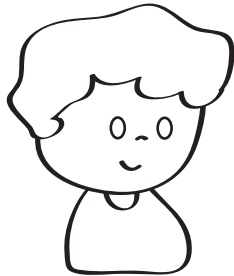

Teacher



Tractor

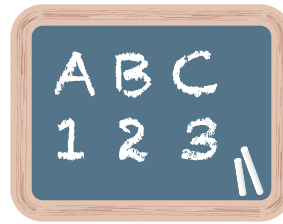

Chalkboard

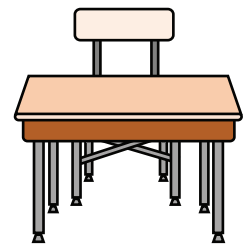

Desk

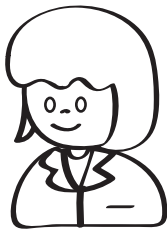

Doctor



Medicine



Hard Hat



Stethoscope

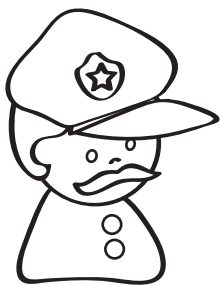

Police Officer



Police Car



Badge



Drums

Name: _____

Date: _____

Tools of the Trade

Draw a line to match each type of tool with the correct community worker.

Doctor



Paint

Farmer

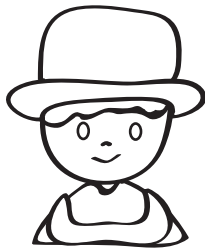

Pot

Hair
Dresser



Shovel &
Rake

Chef

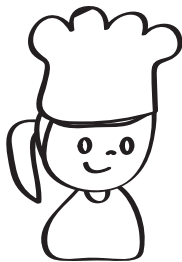

Stethoscope

Painter

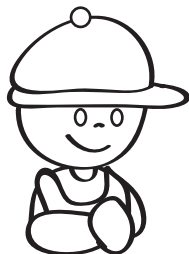

Scissors

Name: _____

Date: _____

Tools of the Trade *PART 2!*

Draw a line to match each type of tool with the correct community worker.

Police Officer



Nuts & Bolts

Singer

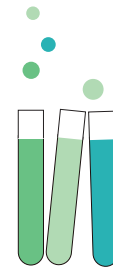
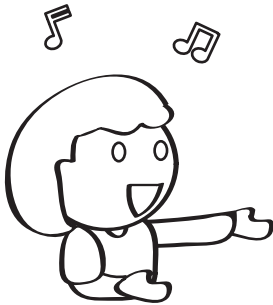

Test Tubes

Scientist

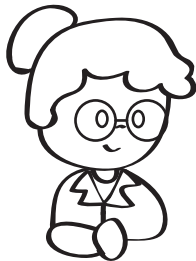

Whistle

Mechanic



Taxi

Taxi Driver

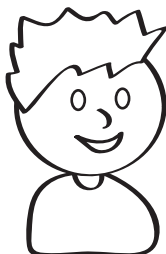

Microphone

Name: _____

Date: _____

Community Helpers Word Search

Directions: Look for the community helpers and their equipment in the puzzle below. Use the word bank to help find all of the community helper words. Look up and down and side to side!

M	A	I	L	C	A	R	R	I	E	R	A	H
F	D	U	S	K	Y	S	C	R	A	P	E	R
P	O	L	I	C	E	O	F	F	I	C	E	R
S	C	U	C	B	O	E	B	I	S	H	H	U
H	T	O	K	U	S	T	A	M	P	A	E	L
H	O	S	E	I	S	K	D	A	D	R	L	E
S	R	B	A	L	C	H	G	S	I	D	M	T
E	S	W	L	D	A	Y	E	P	R	H	E	T
H	A	M	M	E	R	S	T	E	T	A	T	E
I	O	F	I	R	E	F	I	G	H	T	E	R

police officer firefighter doctor hose
letter hard hat sick mail carrier
skyscraper builder stamp
badge dirt hammer

Name: _____

Date: _____

Who Are Your Community Helpers?

Directions: Who are the important community helpers in your neighborhood? Draw four different people who help you in your community and write about each helper using words. Don't forget to add details to your drawings!

<hr/> <hr/> <hr/>	<hr/> <hr/> <hr/>
<hr/> <hr/> <hr/>	<hr/> <hr/> <hr/>

Name: _____

Date: _____

Who's Who?

Directions: Use the word bank below to fill in the community helper sentences. Then draw a line connecting each sentence with the correct picture.

hose hard hat safe teeth
medicine letters books learn



A police officer helps to keep us _____.



A firefighter uses a _____ to put out fires.



A doctor gives us _____ when we are sick.



A builder wears a _____ on the job to stay safe.



A librarian helps us check out _____ from the public library.



A mail carrier delivers _____ to your mailbox.



A dentist helps to keep your _____ clean.



A teacher helps you to _____ new things in school.

Name: _____

Date: _____

Community Helpers

Directions: Can you find all of the community helpers in this busy city scene? Search the picture for all of the hidden community helpers and their equipment. Color in each item when you find it!

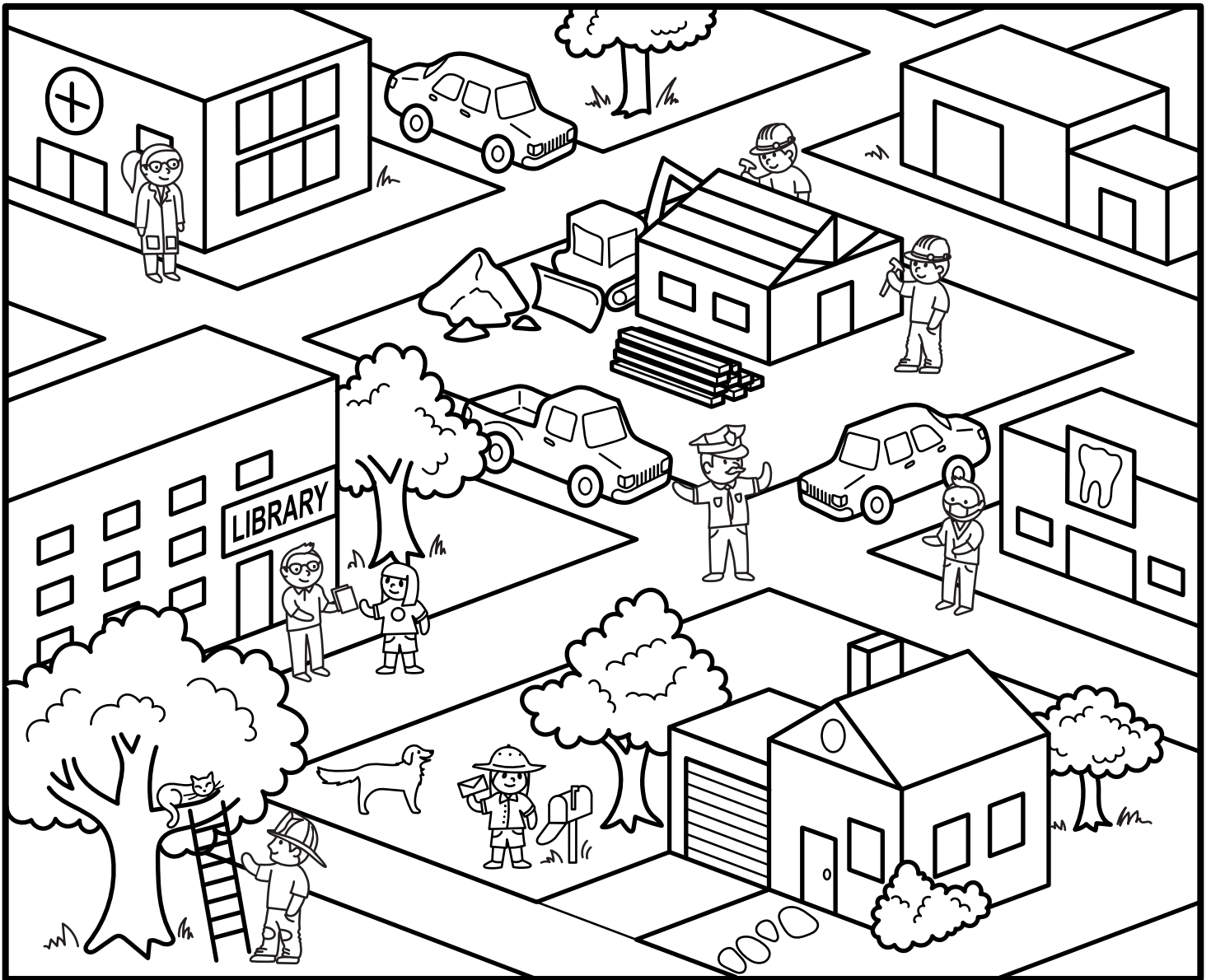

Name: _____

Date: _____

Community Helper Paper Doll

Directions:

1. Color the doll and create a face.
2. Have a parent help cut the doll out.
3. Choose a uniform that you want to go on an adventure with first.
4. Use your imagination and color the uniform the way you see it.
5. Have a parent help cut out the finished outfit.

Hint: Be careful not to cut off the tabs that will help you attach the uniform to the doll.

6. Attach the clothes by folding the tabs toward the back of the doll.
7. Have fun!

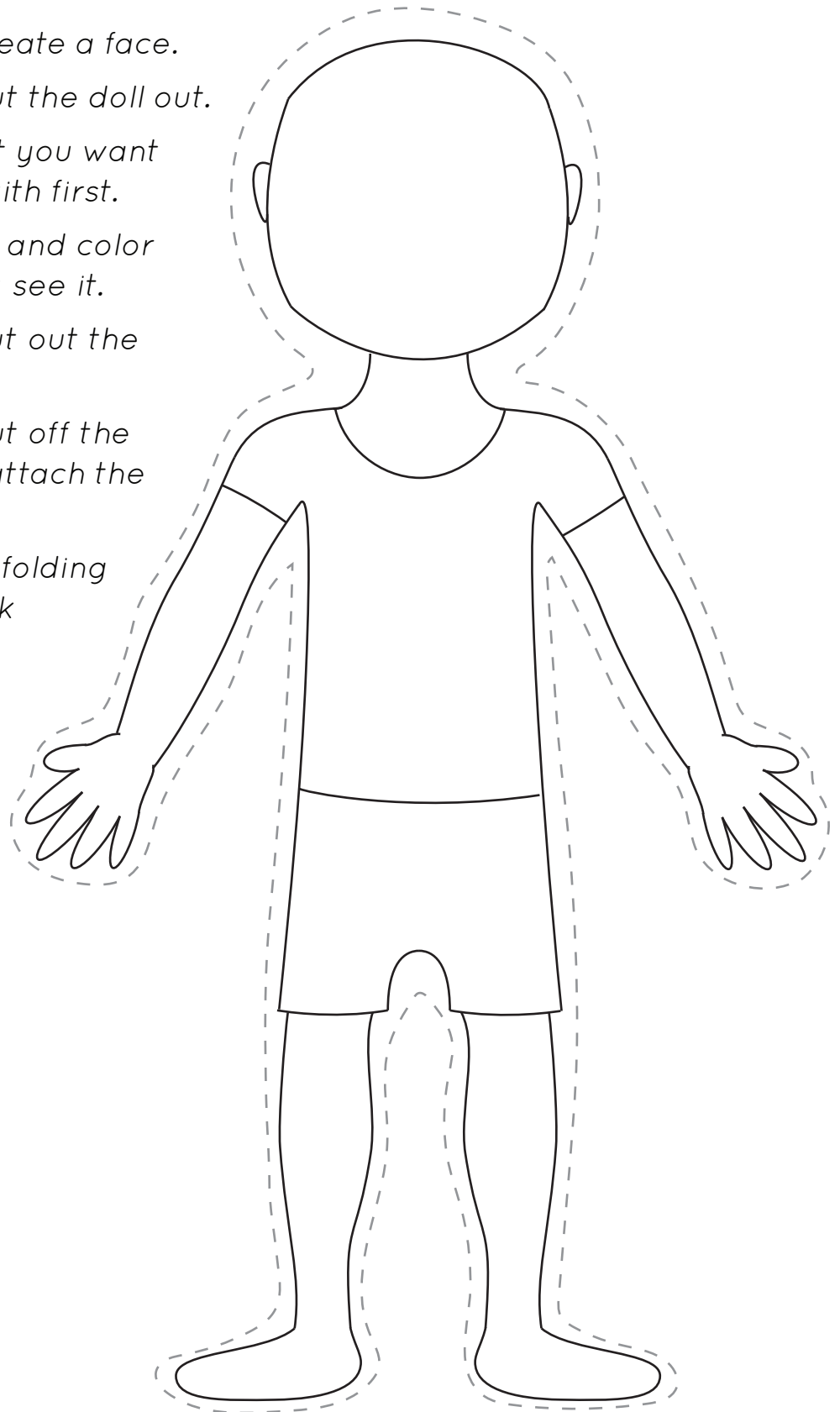

Name: _____

Date: _____

I Want to Be a:

What kind of community worker would you like to be? Use the paper doll to turn yourself into a community worker.

Blank writing area with horizontal lines and dashed midlines for handwriting practice.

Firefighter

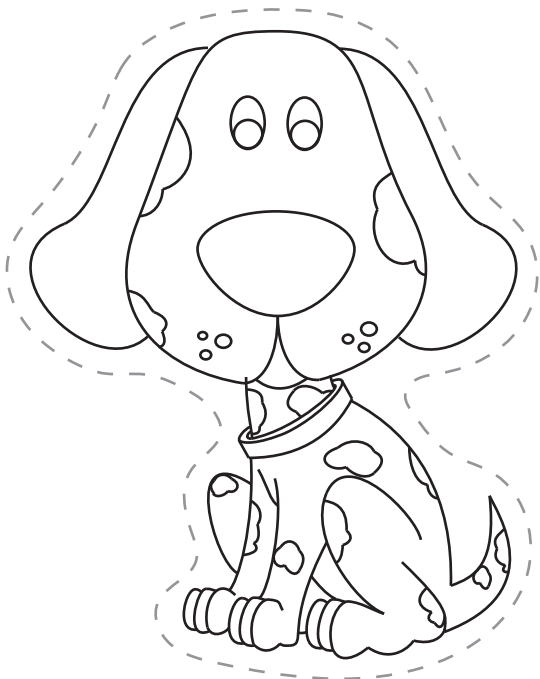
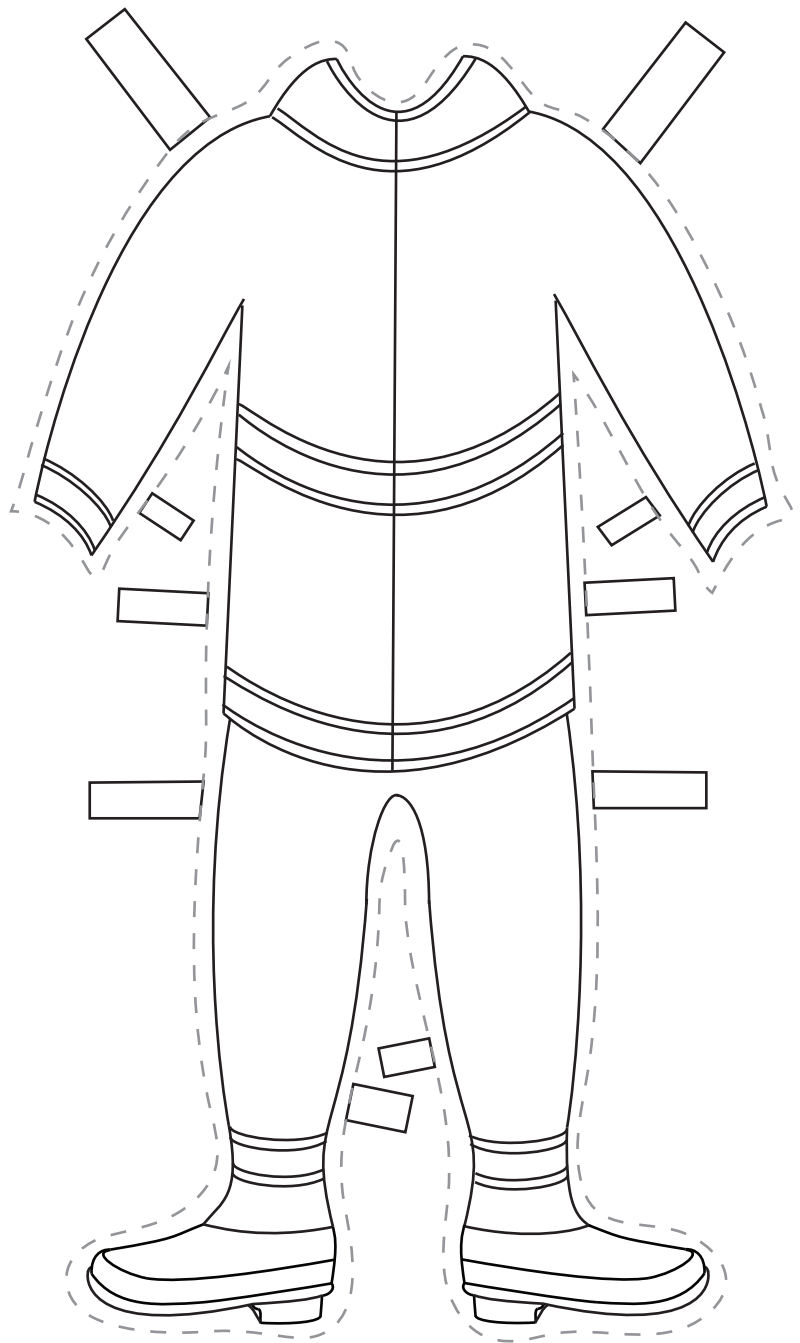
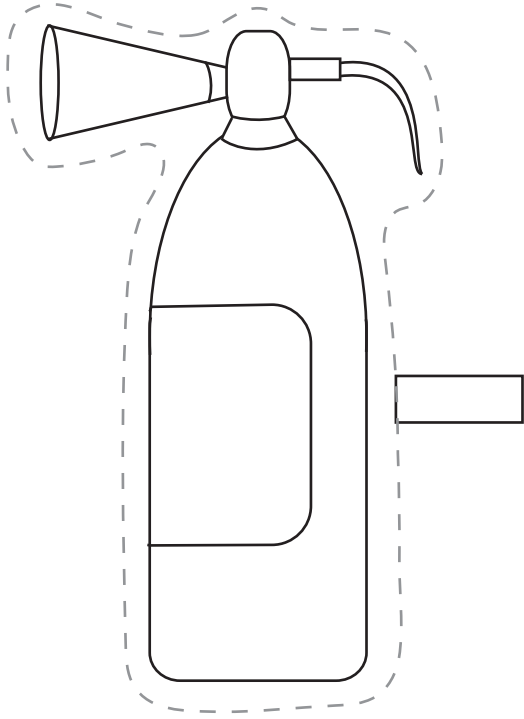
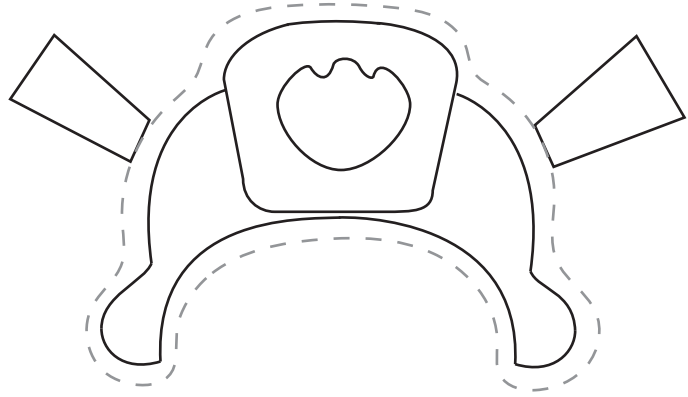

Teacher

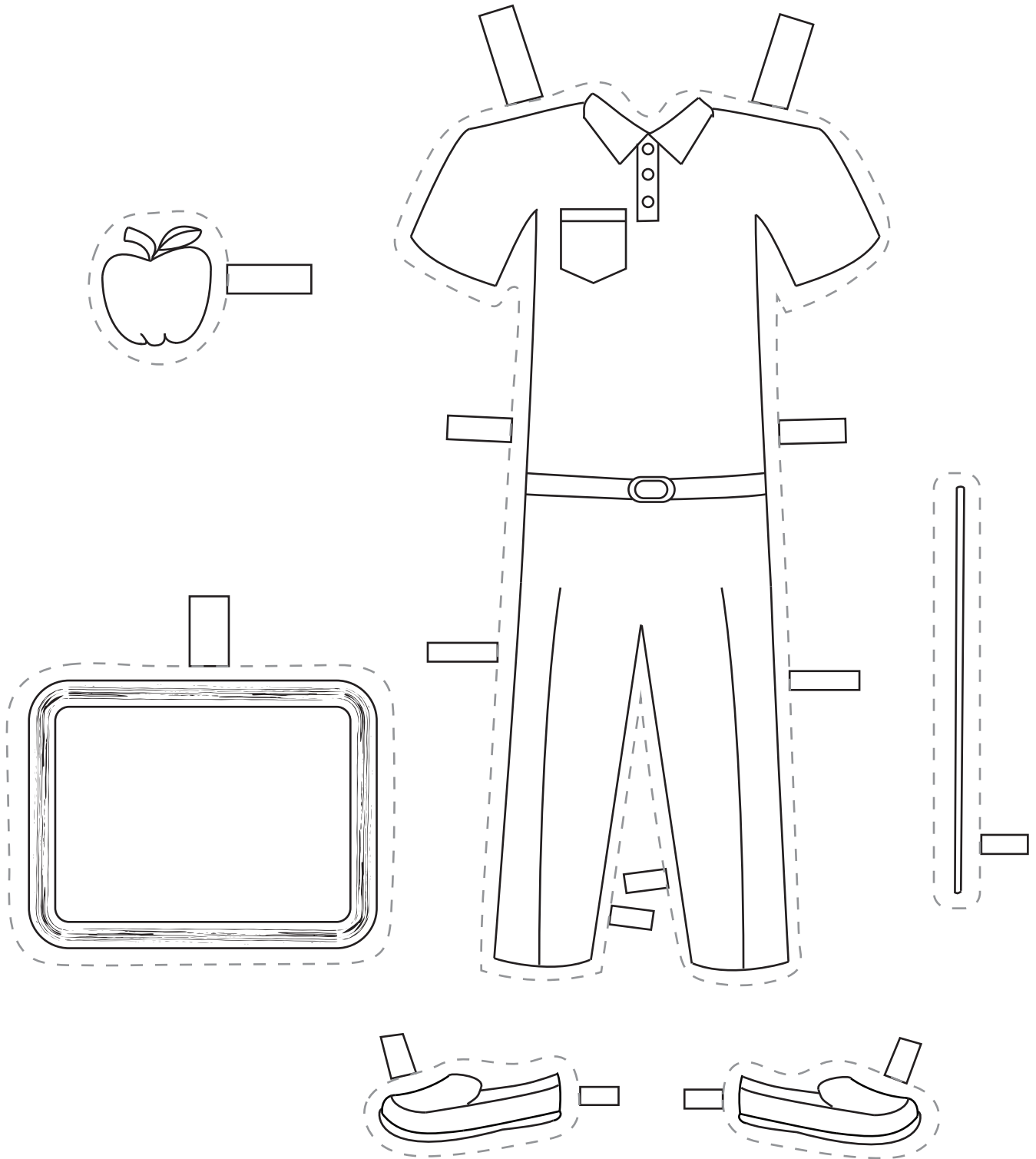

Librarian

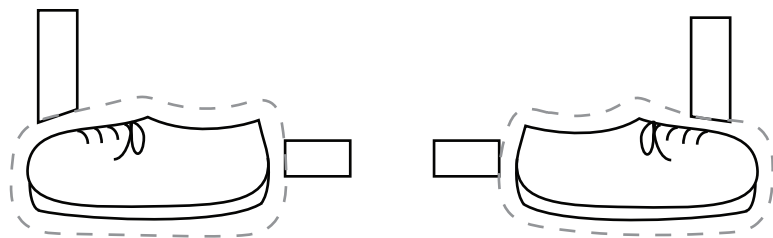
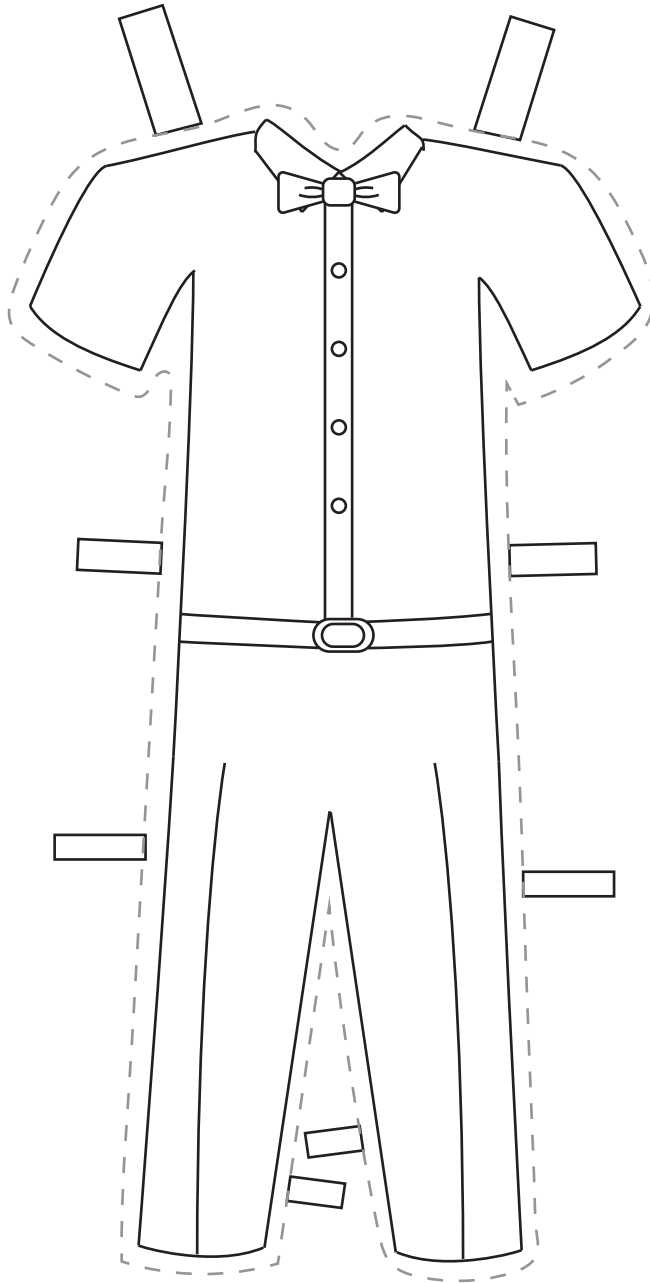
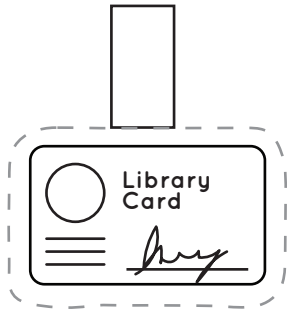

Doctor

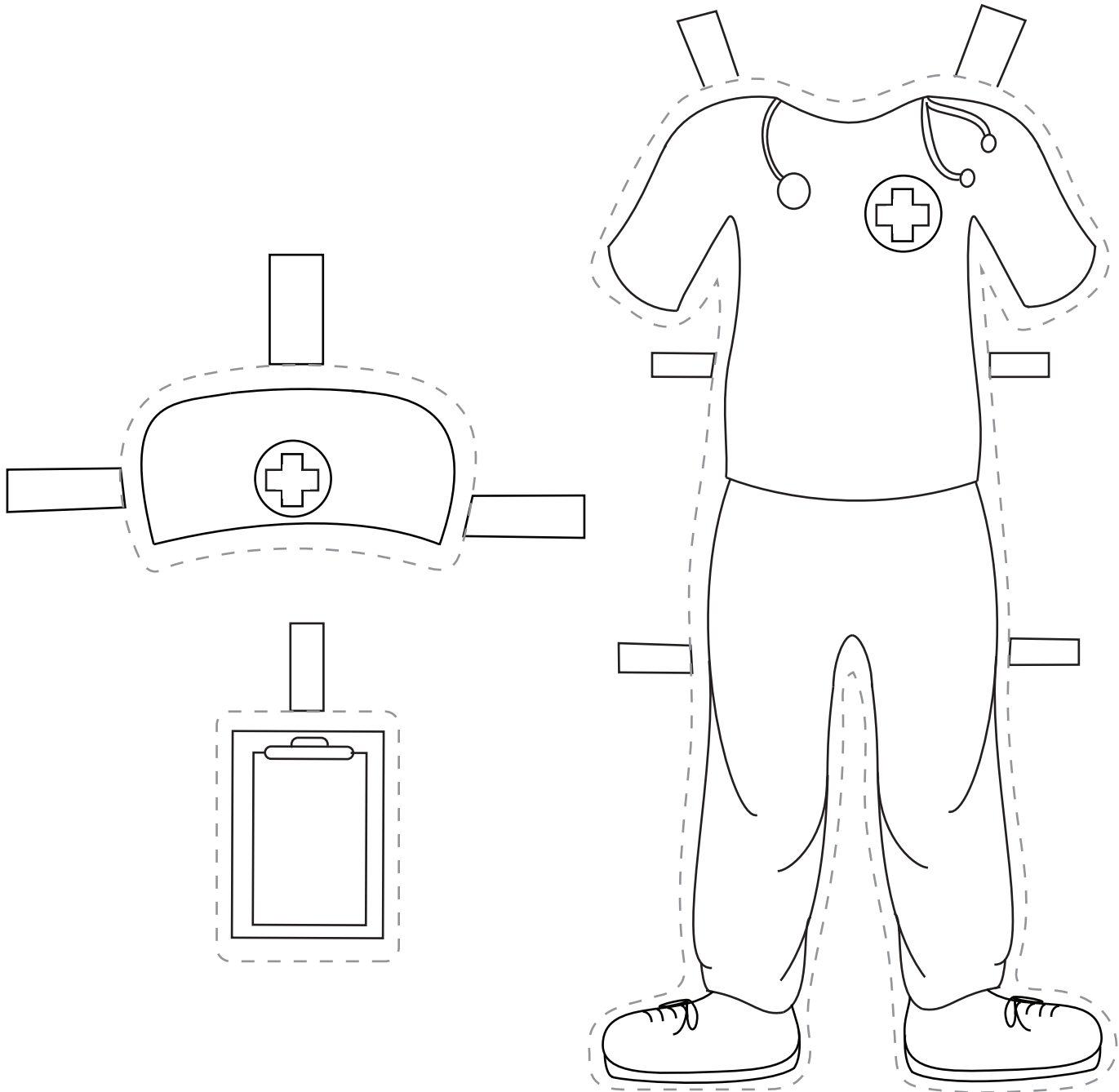

Police Officer

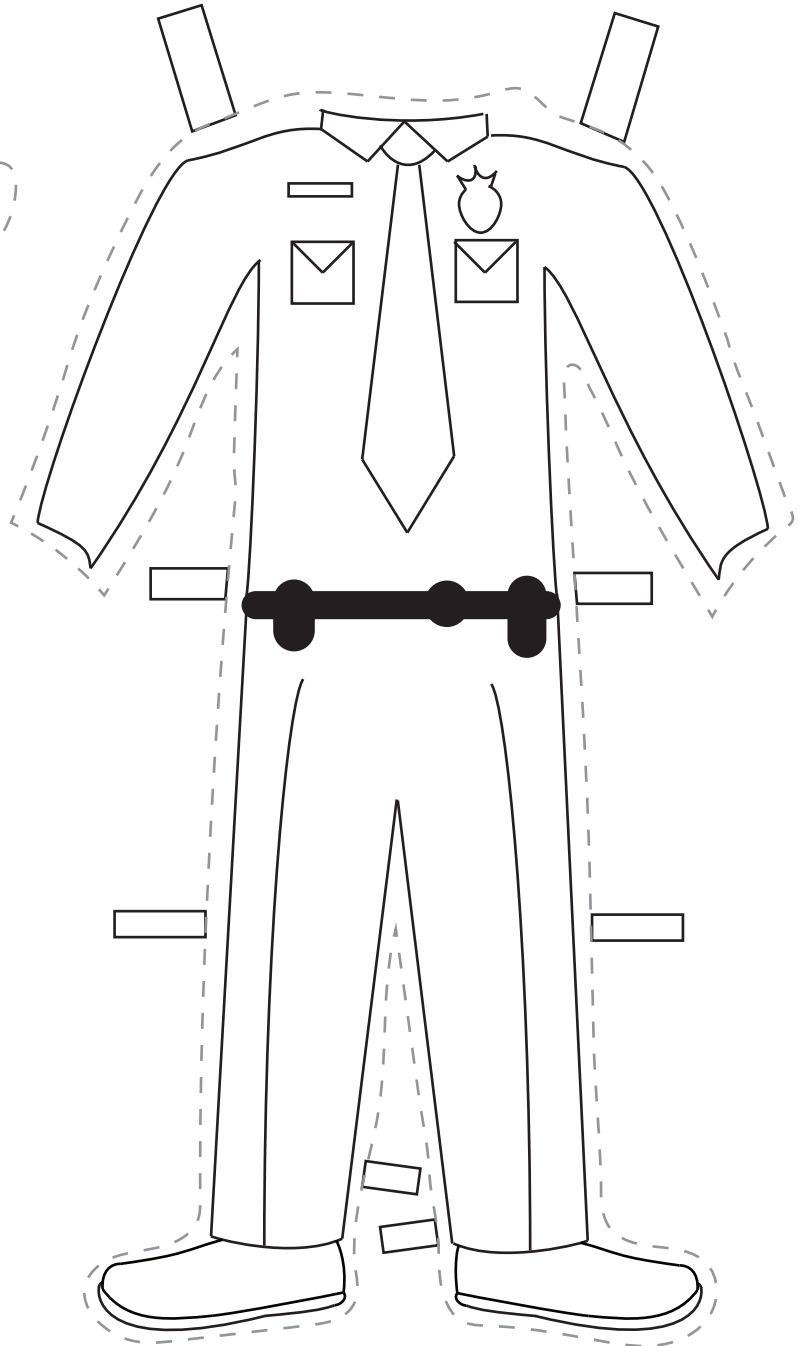
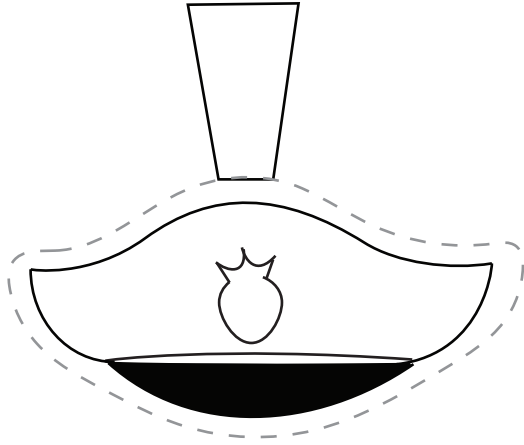

Chef

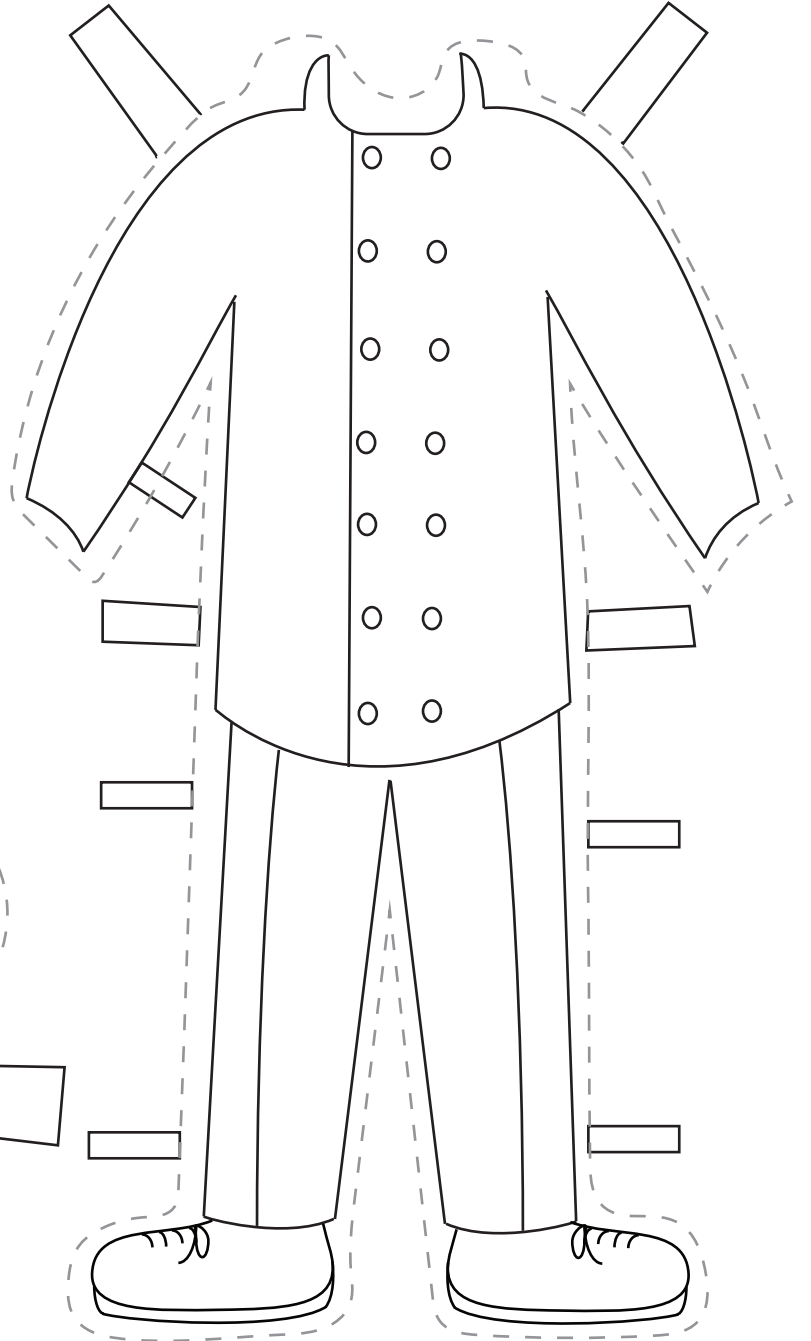
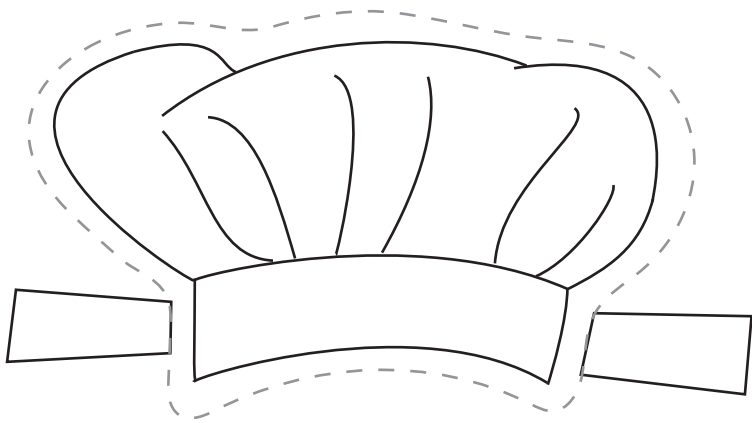
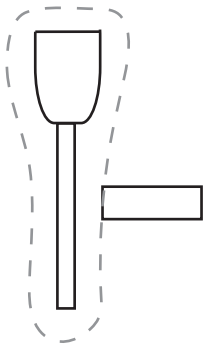
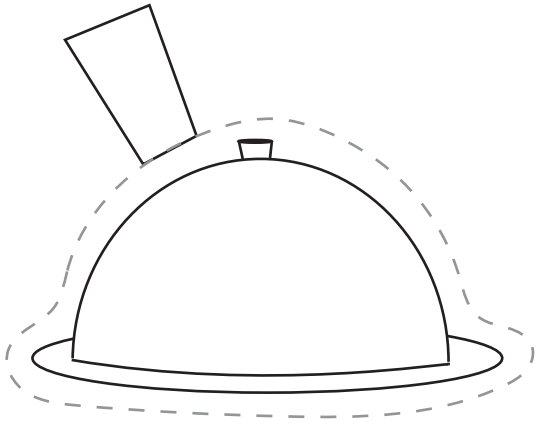

Builder

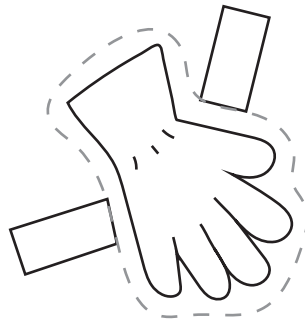
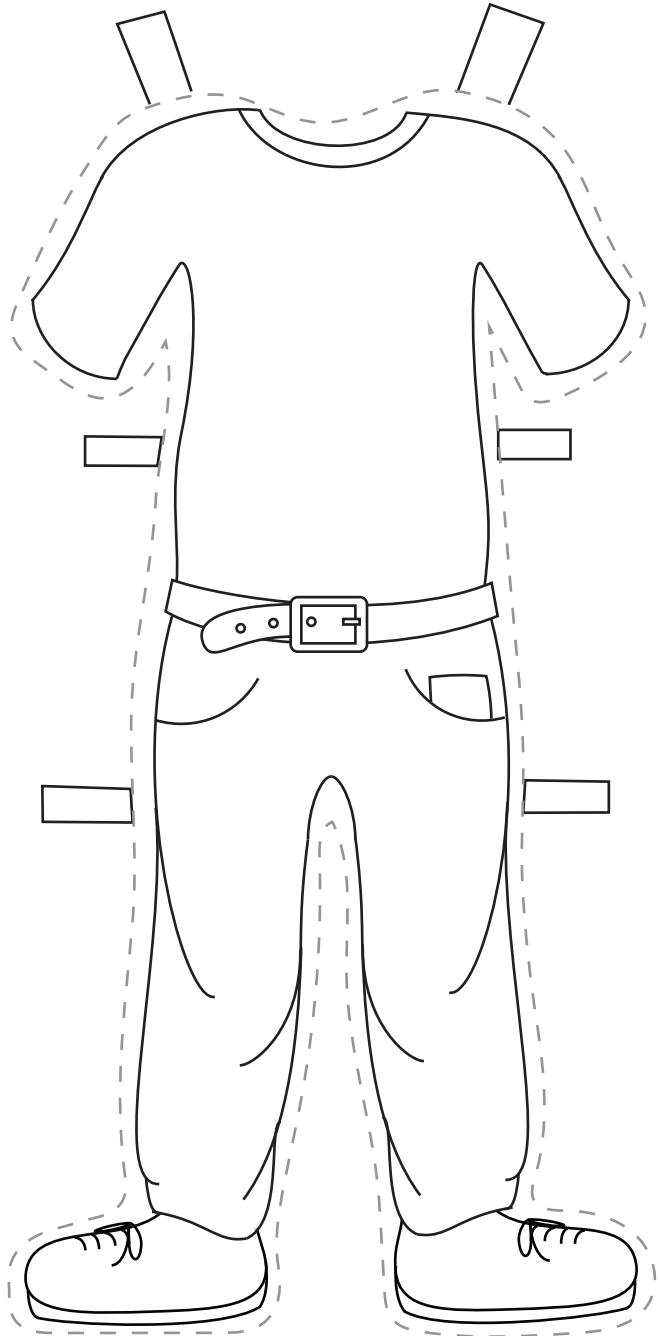
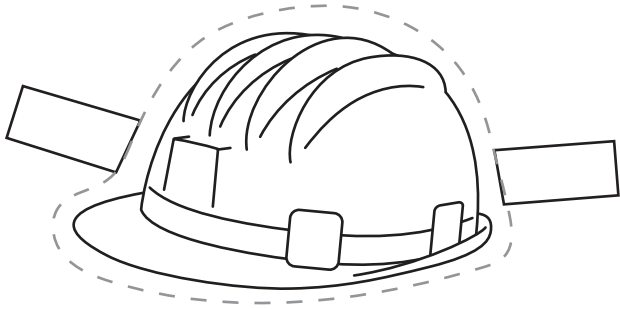

Postal Worker

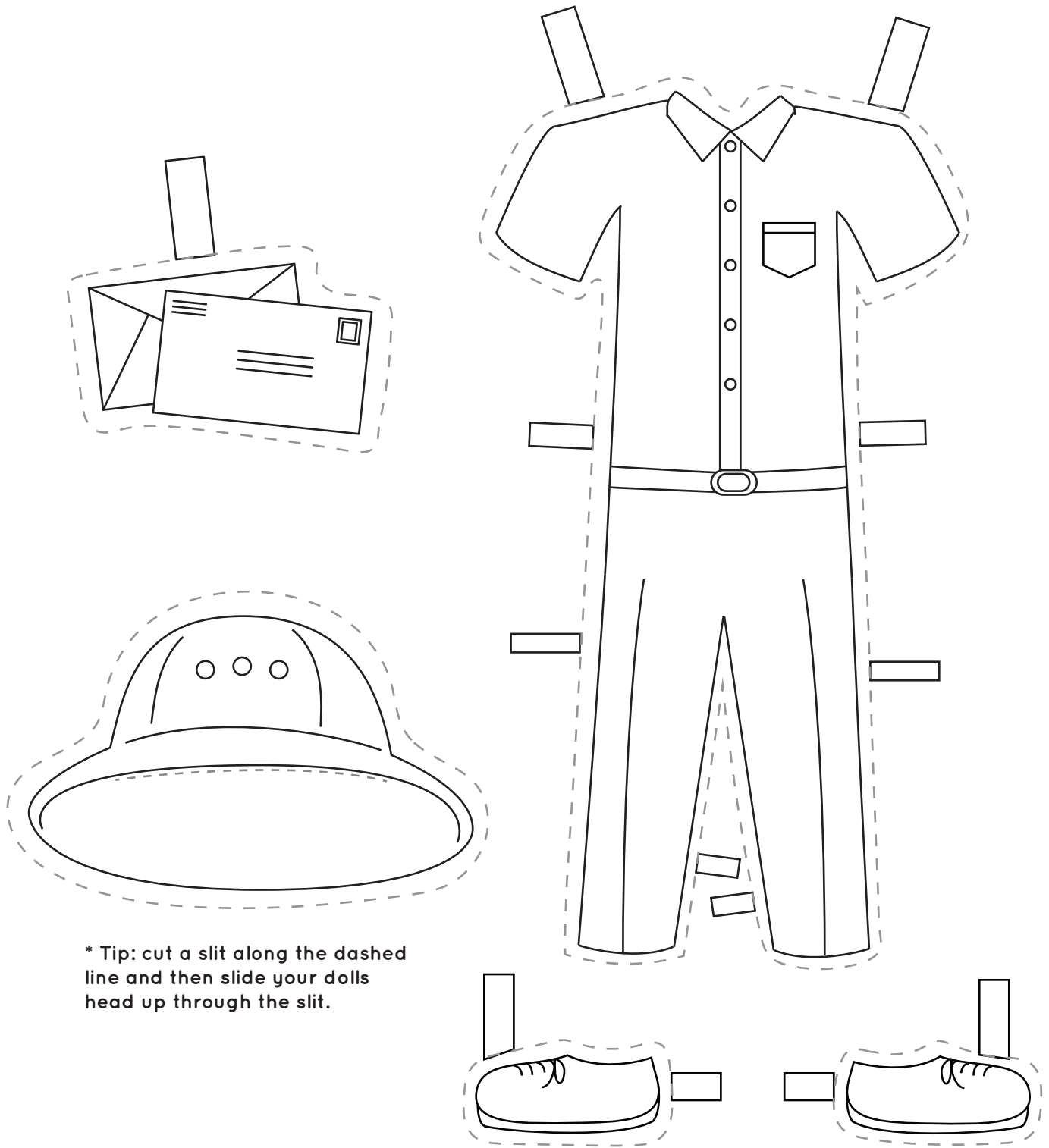

* Tip: cut a slit along the dashed line and then slide your dolls head up through the slit.

Dentist

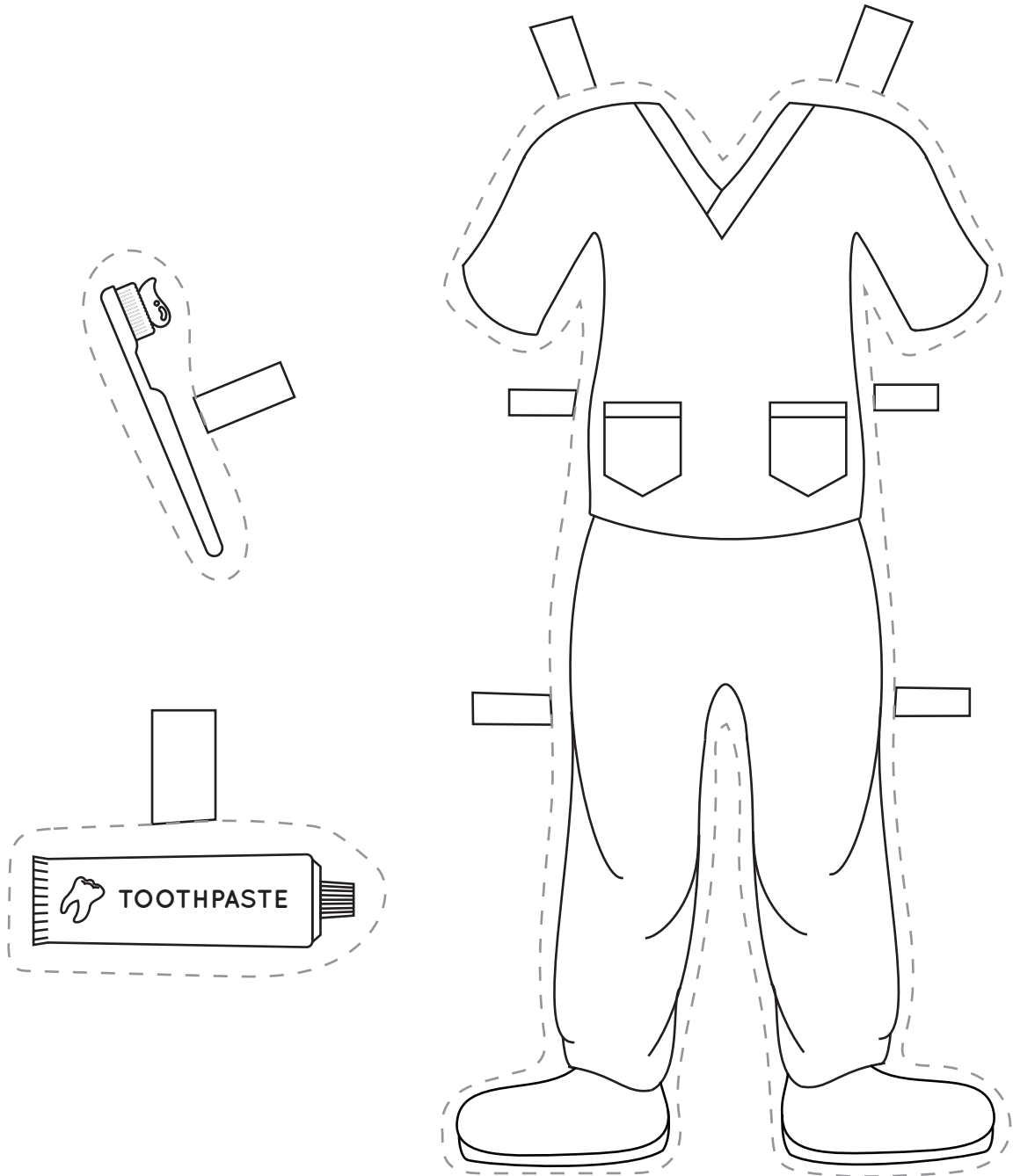

Astronaut

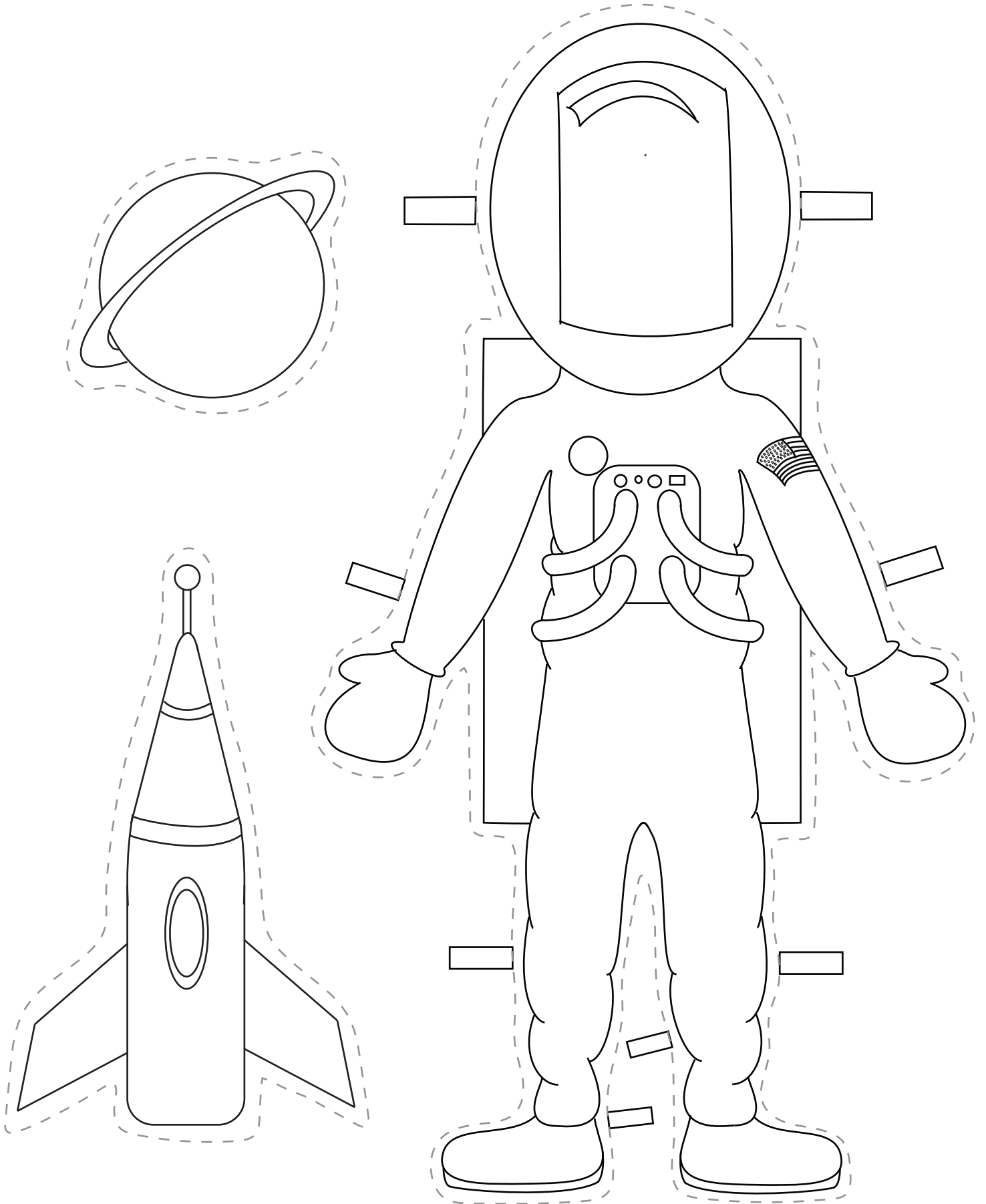

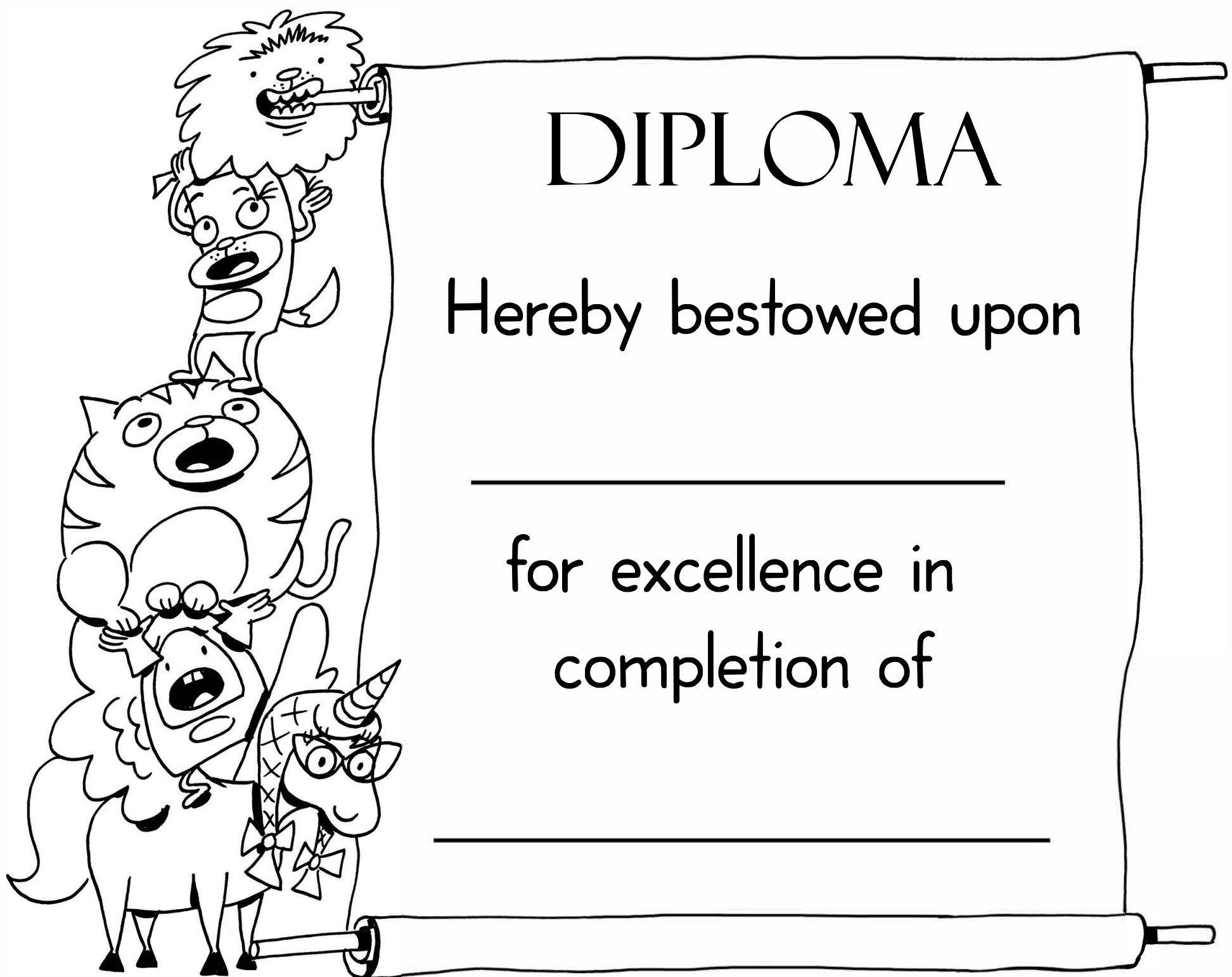

DIPLOMA

Hereby bestowed upon

for excellence in
completion of

Answer Sheets

Community Helpers

Community Helpers

P is for Police Officer

F is for Firefighter

D is for Doctor

M is for Mail Carrier

B is for Builder

Community Vehicles

Which of These Things Is Not Like the Other? (Part One)

Which of These Things Is Not Like the Other? (Part Two)

Tools of Trade

Match the Tools

Community Helpers Word Search

Community Helpers: Who's Who?

Community Helper Hunt

Answer Sheet

Name: _____

Date: _____

ANSWERS Community Helpers

Circle the people whose job is to care for others.

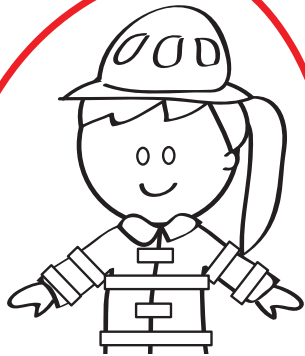

Firefighter

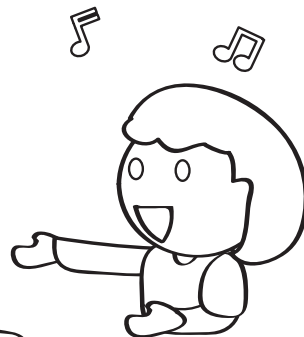

Singer

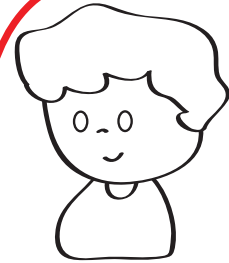

Teacher



Scientist



Doctor



Police Officer

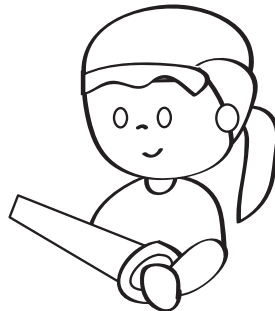

Carpenter



Postman

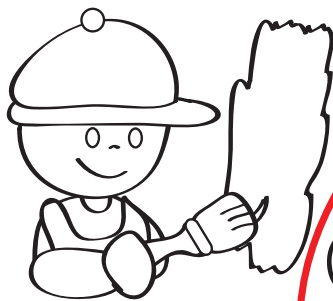

Painter



Babysitter



Nurse

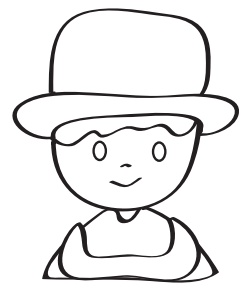

Farmer

Answer Sheet

Name: _____

Date: _____

ANSWERS P is for Police Officer

Police officers patrol the streets to keep us safe. They also help to direct traffic and help people when in need. Police officers wear a special uniform and carry special things that tell us who they are.

Directions: Color in all of the objects that a police officer uses in the line of duty. Then label each one with the correct name using the word bank at the bottom of the page.



badge

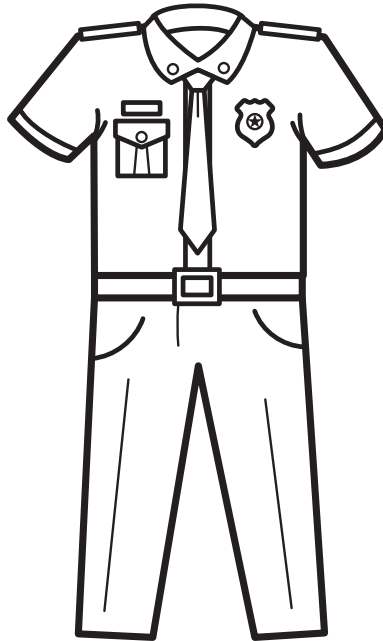

uniform

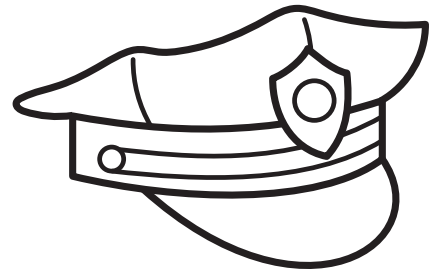

police hat

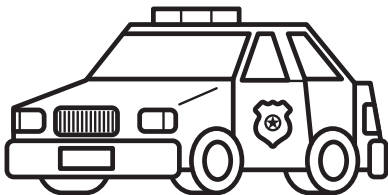

police car

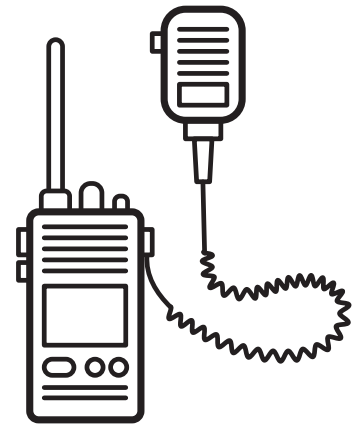

radio

police car badge radio
police hat uniform

Answer Sheet

Name: _____

Date: _____

ANSWERS F is for Firefighter

Firefighters have a very dangerous job! Firefighters rescue people in danger and put out fires, but they also teach us about fire prevention and how to stay safe.

Directions: Color in all of the objects that a firefighter uses in the line of duty. Then label each one with the correct name using the word bank at the bottom of the page.

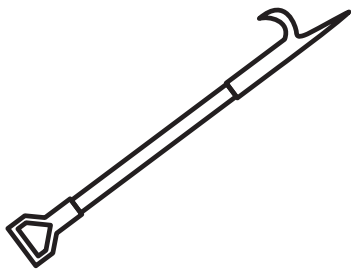

hook



fire-proof suit



boots

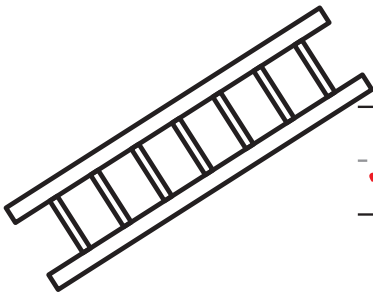

ladder

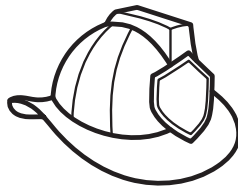

helmet

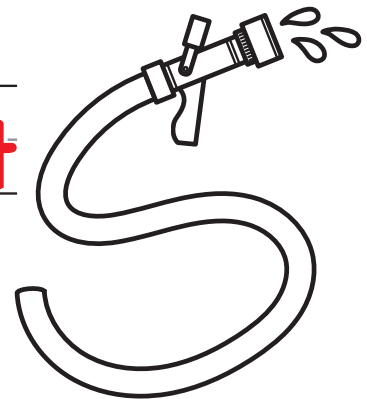

hose

helmet

fire-proof suit

hose

ladder

hook

boots

Answer Sheet

Name: _____

Date: _____

ANSWERS

D is for Doctor

Doctors have a very important job! They take care of us when we are sick and help to make us healthy by giving us medicine, taking our temperatures, and bandaging our wounds. You can visit a doctor in an office or in the hospital.

Directions: Color in all of the objects that a doctor uses to help keep us healthy. Then label each one with the correct name using the word bank at the bottom of the page.

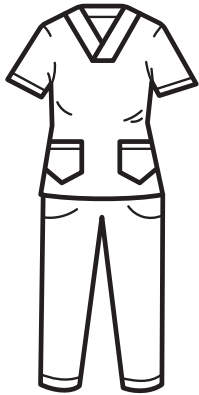

scrubs

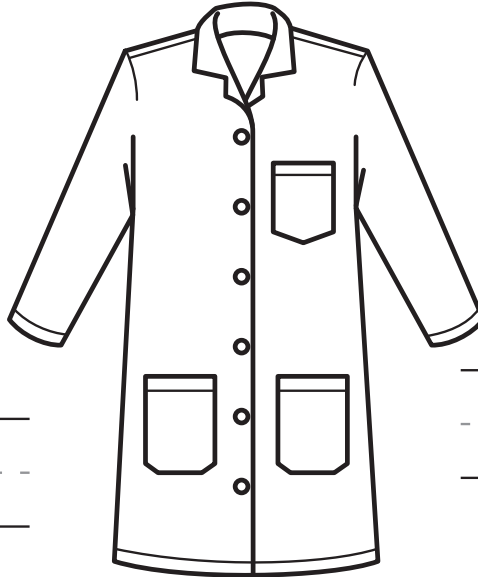

lab coat



stethoscope

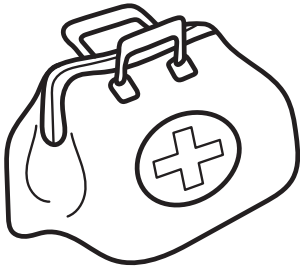

medical bag

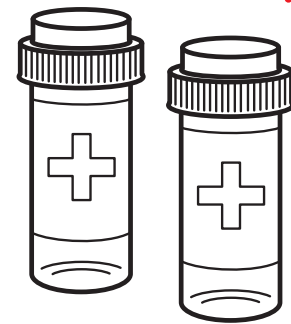

medicine

scrubs lab coat stethoscope
medicine medical bag

Answer Sheet

Name: _____

Date: _____

ANSWERS M is for Mail Carrier

Mail carriers have a very important job! They deliver letters and packages to us each day. Mail carriers sometimes drive mail trucks and sometimes walk from house to house to deliver the mail.

Directions: Color in all of the objects that a mail carrier might use to deliver the mail. Then label each one with the correct name using the word bank at the bottom of the page.

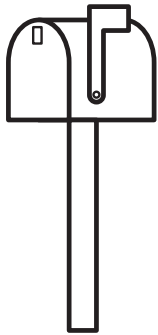

mailbox

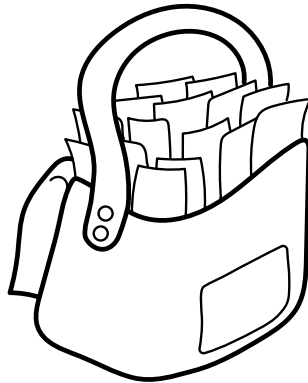

mail bag



letters

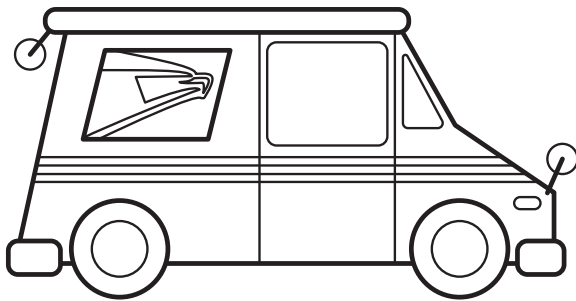

mail truck

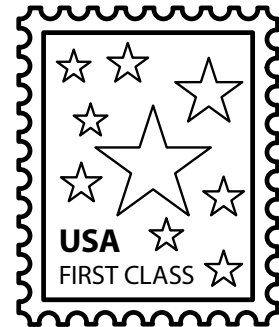

stamps

mail truck mail bag letters
stamps mailbox

Answer Sheet

Name: _____ Date: _____

ANSWERS

B is for Builder

Builders and construction workers have a very important job! They help to build things in our community like roads, bridges, skyscrapers, and houses. Builders use big machines like diggers and bulldozers to get the job done. They wear hard hats to keep them safe on the job!

Directions: Color in all of the objects that a builder might use when they are working in the community. Then label each one with the correct name using the word bank at the bottom of the page.

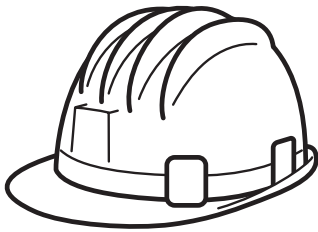

hard hat

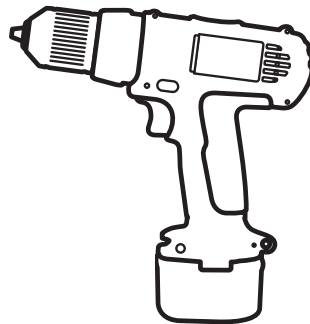

drill

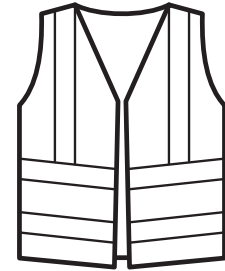

safety vest



boots

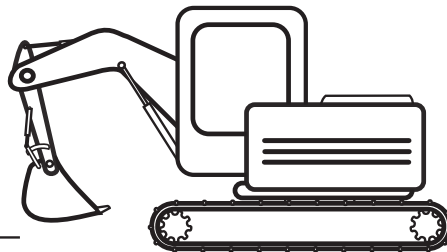

digger

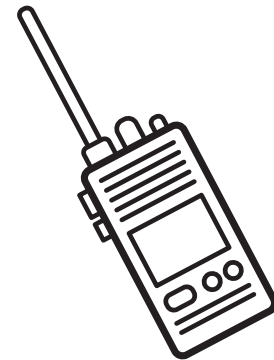

walkie-talkie

hard hat digger walkie-talkie boots
safety vest drill

Answer Sheet

Name: _____ Date: _____

ANSWERS Community Vehicles

Draw a line through the maze connecting the community workers with their vehicles.

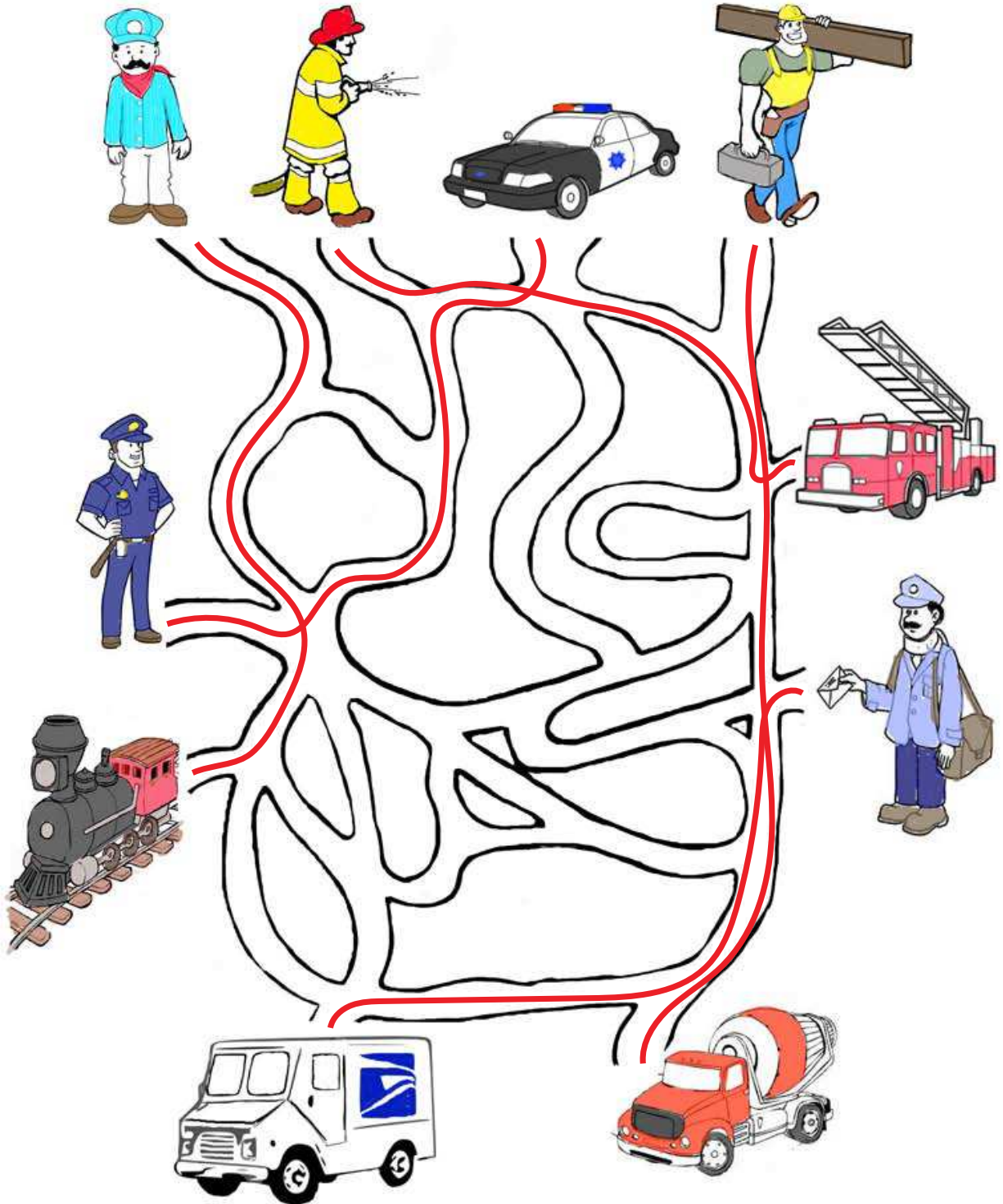

Answer Sheet

Name: _____ Date: _____

ANSWERS Which Of These Things Is Not Like the Other?

In each row, circle the thing that does not go with the first picture.

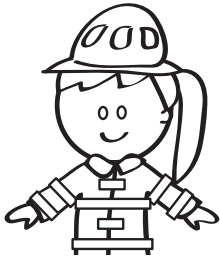

Firefighter



Hydrant



Spoon



Fire Truck



Builder



Juice



Hammer



House

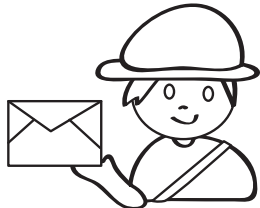

Mail Carrier



Letters



Ice Cream

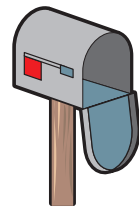

Mail Box

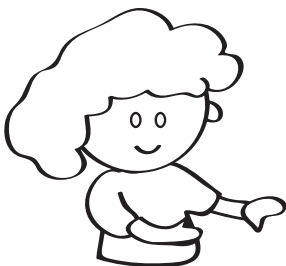

Grocer



Money



Vegetables



Slippers

Answer Sheet

Name: _____

Date: _____

ANSWERS Which Of These Things Is Not Like the Other? PART 2!

In each row, circle the thing that does not go with the first picture.



Librarian



Books



Basketball



Library Card

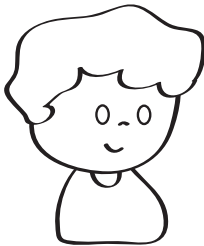

Teacher



Tractor

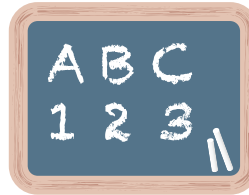

Chalkboard

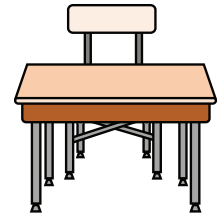

Desk

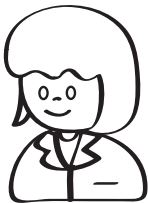

Doctor



Medicine



Hard Hat



Stethoscope

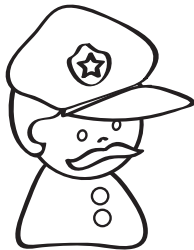

Police Officer



Police Car



Badge





Drums



Answer Sheet

Name: _____ Date: _____

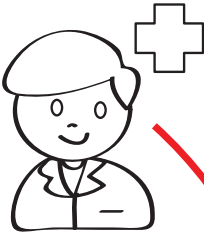

ANSWERS Tools of the Trade

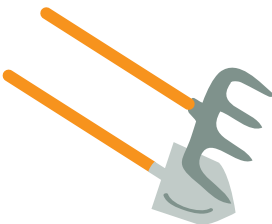

Draw a line to match each type of tool with the correct community worker.

Doctor   Paint

Farmer   Pot

Hair Dresser   Shovel & Rake

Chef   Stethoscope

Painter   Scissors

Answer Sheet

Name: _____

Date: _____

ANSWERS Tools of the Trade PART 2!

Draw a line to match each type of tool with the correct community worker.

Police Officer



Singer

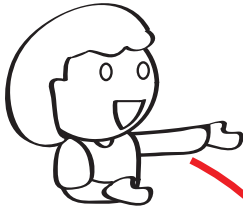

Scientist



Mechanic



Taxi Driver



Nuts & Bolts



Test Tubes

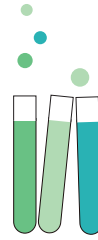

Whistle



Taxi



Microphone



Answer Sheet

Name: _____

Date: _____

Community Helpers Word Search

ANSWERS

Directions: Look for the community helpers and their equipment in the puzzle below. Use the word bank to help find all of the community helper words. Look up and down and side to side!

M	A	I	L	C	A	R	R	I	E	R	A	H
F	D	U	S	K	Y	S	C	R	A	P	E	R
P	O	L	I	C	E	O	F	F	I	C	E	R
S	C	U	C	B	O	E	B	I	S	H	H	U
H	T	O	K	U	S	T	A	M	P	A	E	L
H	O	S	E	I	S	K	D	A	D	R	L	E
S	R	B	A	L	C	H	G	S	I	D	M	T
E	S	W	L	D	A	Y	E	P	R	H	E	T
H	A	M	M	E	R	S	T	E	T	A	T	E
I	O	F	I	R	E	F	I	G	H	T	E	R

police officer firefighter doctor hose
letter hard hat sick mail carrier
skyscraper builder stamp
badge dirt hammer

Answer Sheet

Name: _____ Date: _____

ANSWERS

Who's Who?

Directions: Use the word bank below to fill in the community helper sentences. Then draw a line connecting each sentence with the correct picture.

hose hard hat safe teeth
medicine letters books learn



A police officer helps to keep us safe.

A firefighter uses a hose to put out fires.

A doctor gives us medicine when we are sick.

A builder wears a hard hat on the job to stay safe.

A librarian helps us check out books from the public library.

A mail carrier delivers letters to your mailbox.

A dentist helps to keep your teeth clean.

A teacher helps you to learn new things in school.

Answer Sheet

Name: _____ Date: _____

ANSWERS Community Helpers

Directions: Can you find all of the community helpers in this busy city scene? Search the picture for all of the hidden community helpers and their equipment. Color in each item when you find it!

