

ABC

ALPHABET
flashcards

K
Kindergarten

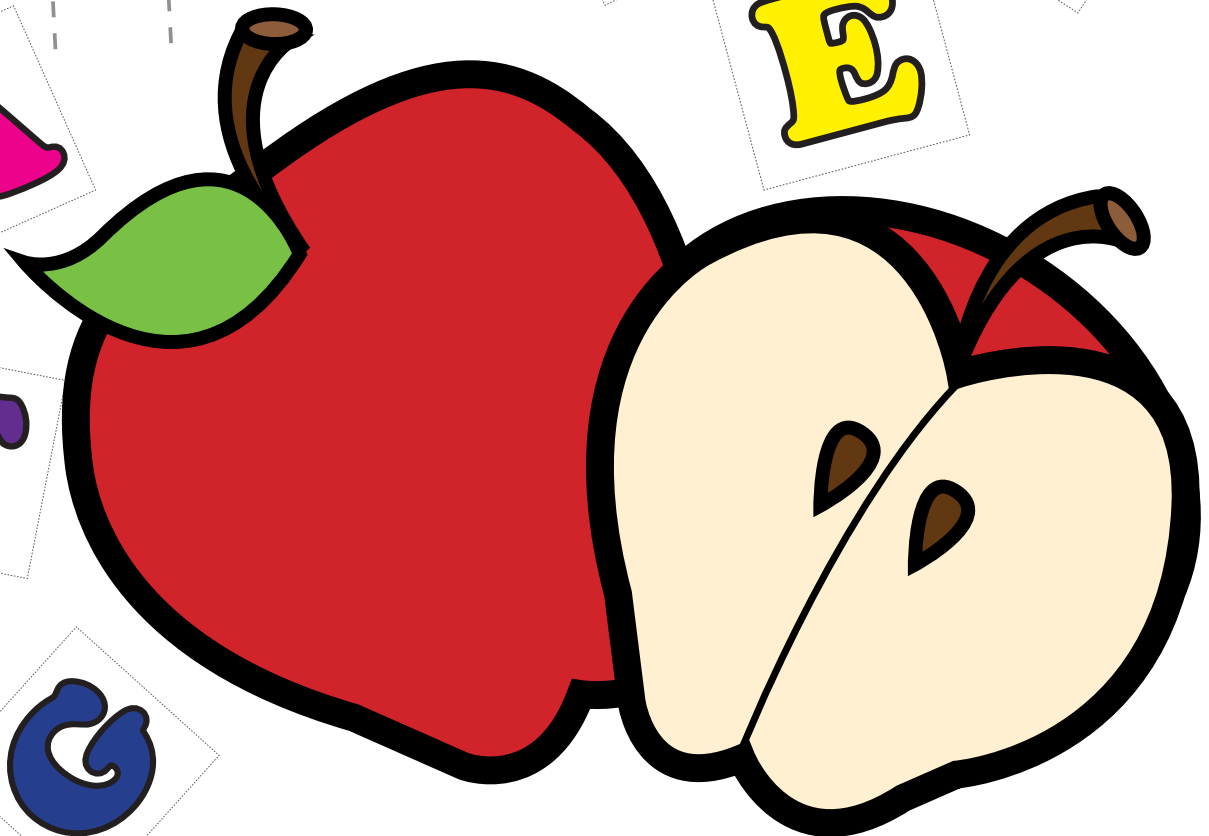
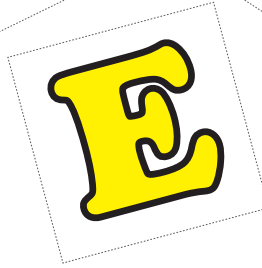
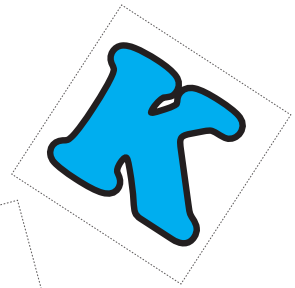
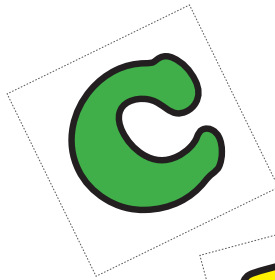
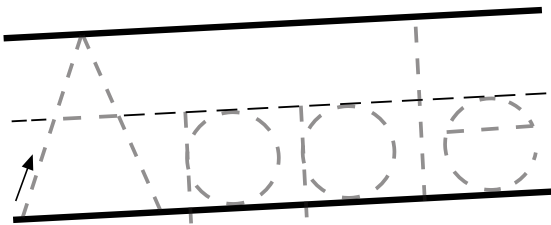

Table of Contents

Alphabet Flash Cards

Alphabet Flashcards: A
Alphabet Flashcards: B
Alphabet Flashcards: C
Alphabet Flashcards: D
Alphabet Flashcards: E
Alphabet Flashcards: F
Alphabet Flashcards: G
Alphabet Flashcards: H
Alphabet Flashcards: I
Alphabet Flashcards: J
Alphabet Flashcards: K
Alphabet Flashcards: L
Alphabet Flashcards: M
Alphabet Flashcards: N
Alphabet Flashcards: O
Alphabet Flashcards: P
Alphabet Flashcards: Q
Alphabet Flashcards: R
Alphabet Flashcards: S
Alphabet Flashcards: T
Alphabet Flashcards: U
Alphabet Flashcards: V
Alphabet Flashcards: W
Alphabet Flashcards: X
Alphabet Flashcards: Y
Alphabet Flashcards: Z

Certificate of Completion

ABC FLASH CARDS

Have your kindergartner color in the pictures and trace the word along the dotted lines.

You can also reuse these flash cards by playing games with them:

- Mix them up and challenge your child to put them back in order
- Ask him to spell names, words, and sentences
- Mix them up, turn them face-down and play a memory matching game!

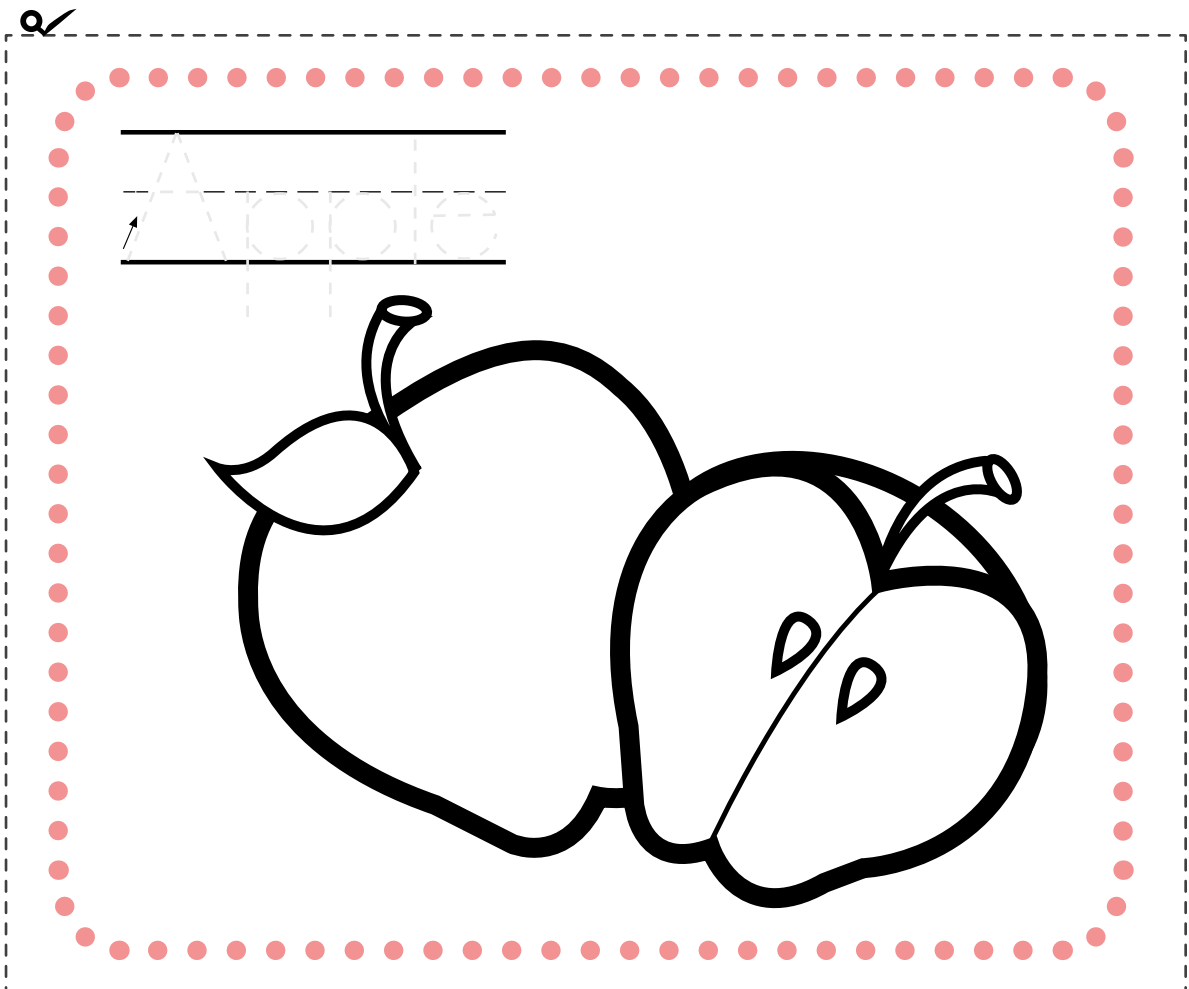
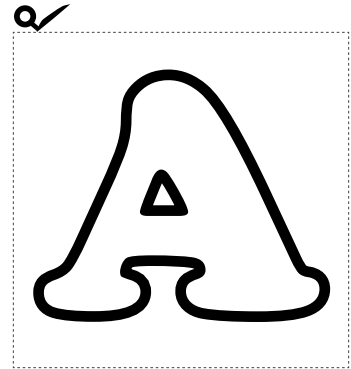
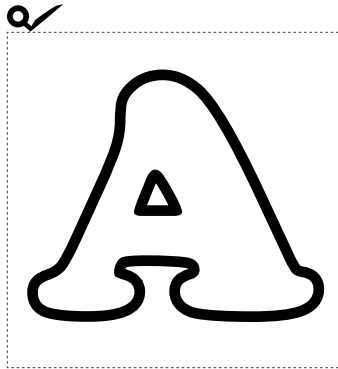
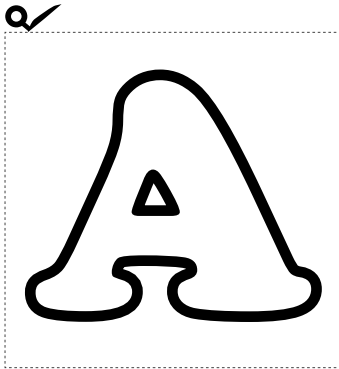

ABC FLASH CARDS

Have your kindergartner color in the pictures and trace the word along the dotted lines.

You can also reuse these flash cards by playing games with them:

- Mix them up and challenge your child to put them back in order
- Ask him to spell names, words, and sentences
- Mix them up, turn them face-down and play a memory matching game!

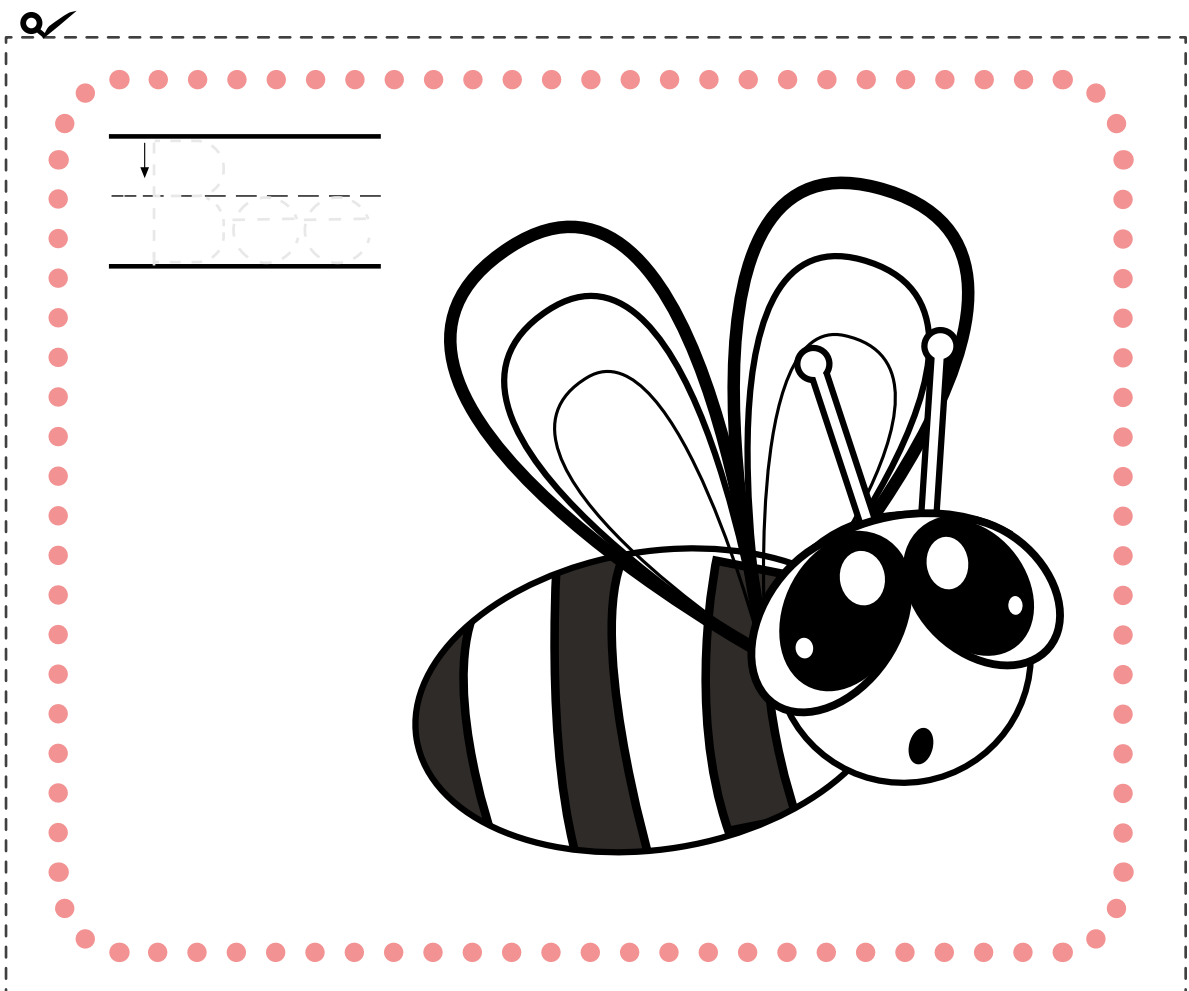
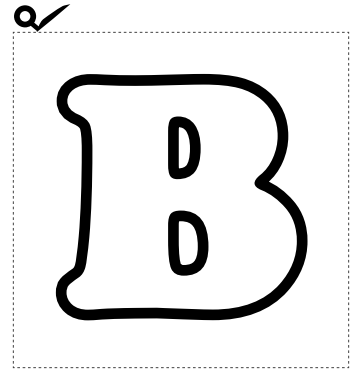
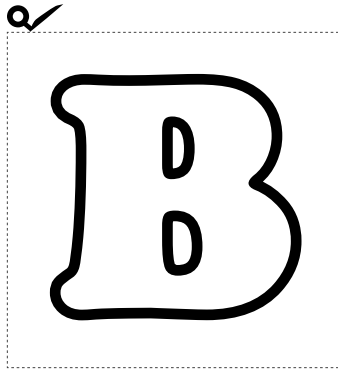
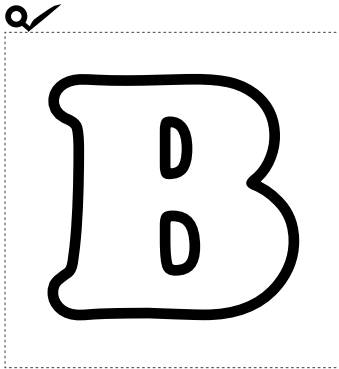

ABC FLASH CARDS

Have your kindergartner color in the pictures and trace the word along the dotted lines.

You can also reuse these flash cards by playing games with them:

- Mix them up and challenge your child to put them back in order
- Ask him to spell names, words, and sentences
- Mix them up, turn them face-down and play a memory matching game!

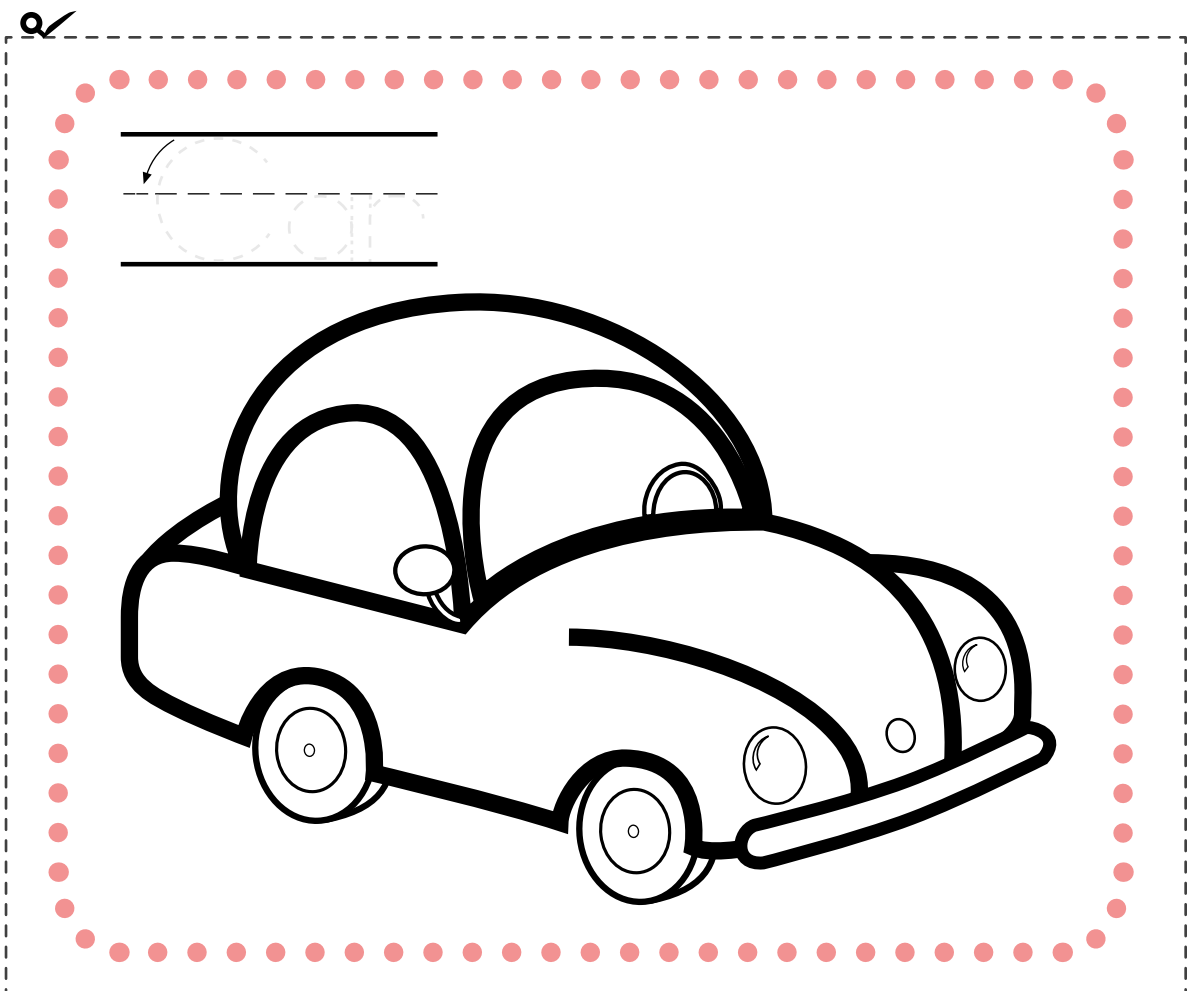
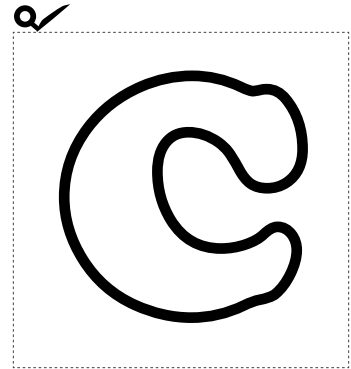
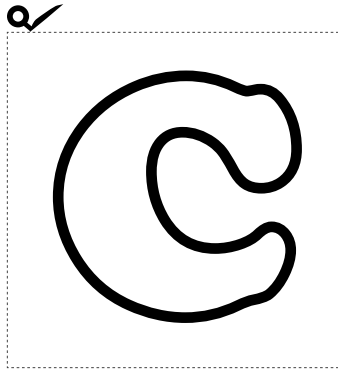
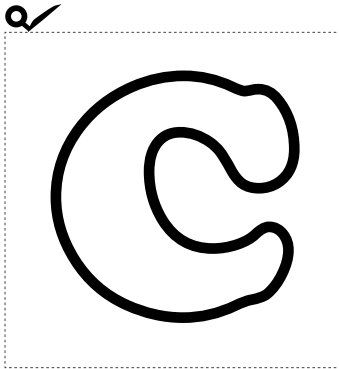



Have your kindergartner color in the pictures and trace the word along the dotted lines.

You can also reuse these flash cards by playing games with them:

- Mix them up and challenge your child to put them back in order
- Ask him to spell names, words, and sentences
- Mix them up, turn them face-down and play a memory matching game!

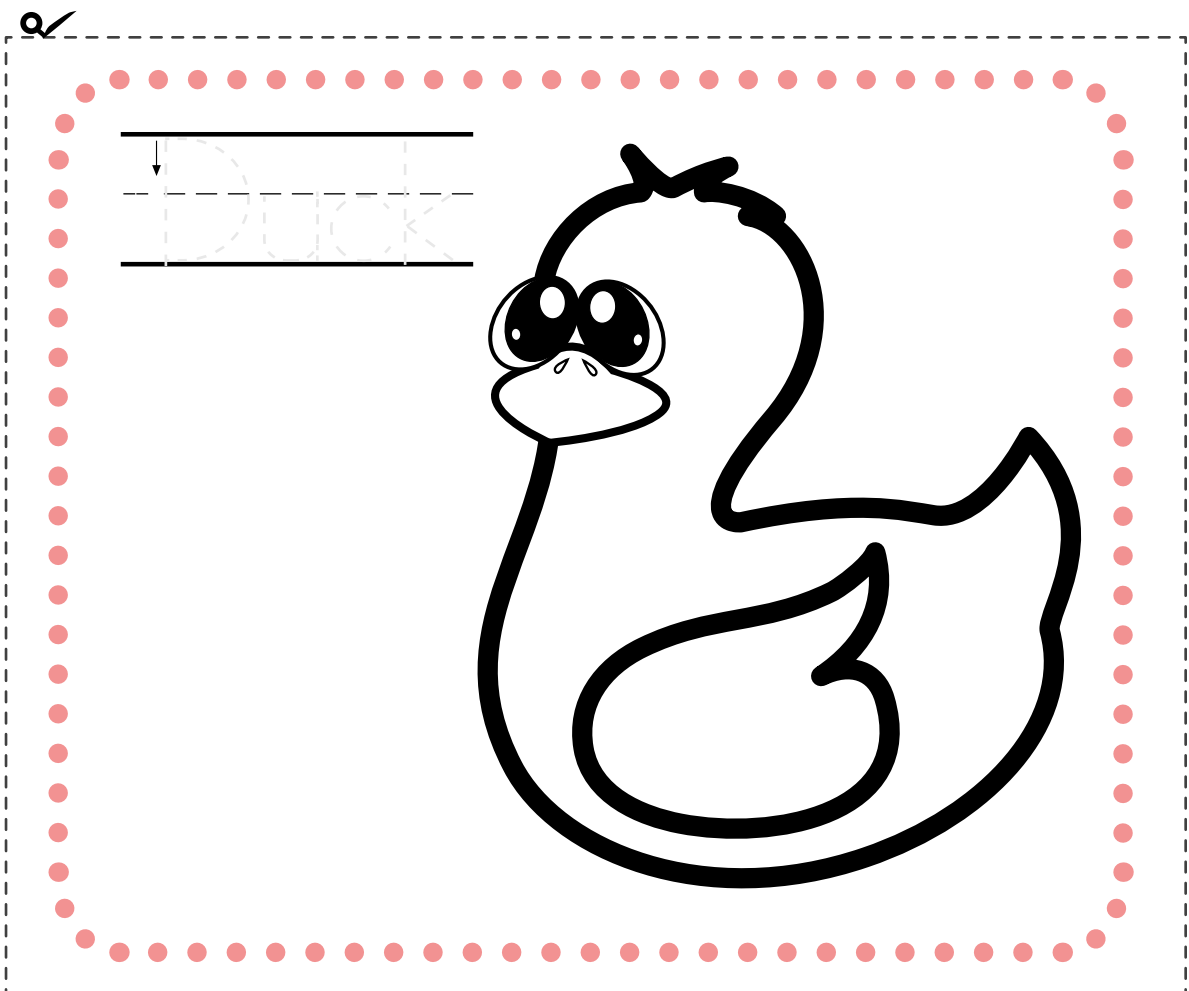
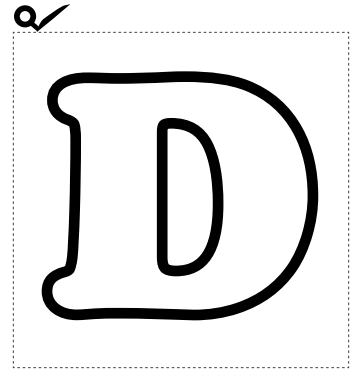
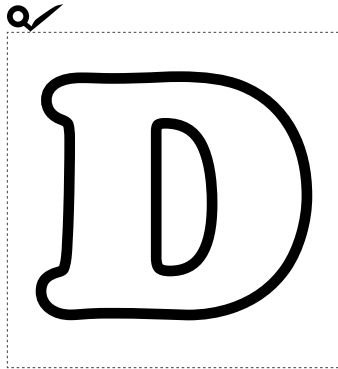
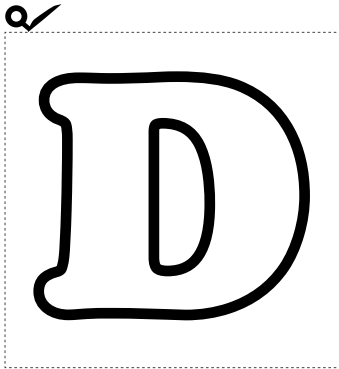

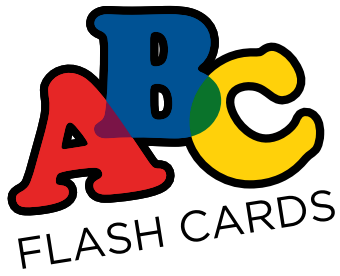

Have your kindergartner color in the pictures and trace the word along the dotted lines.

You can also reuse these flash cards by playing games with them:

- Mix them up and challenge your child to put them back in order
- Ask him to spell names, words, and sentences
- Mix them up, turn them face-down and play a memory matching game!

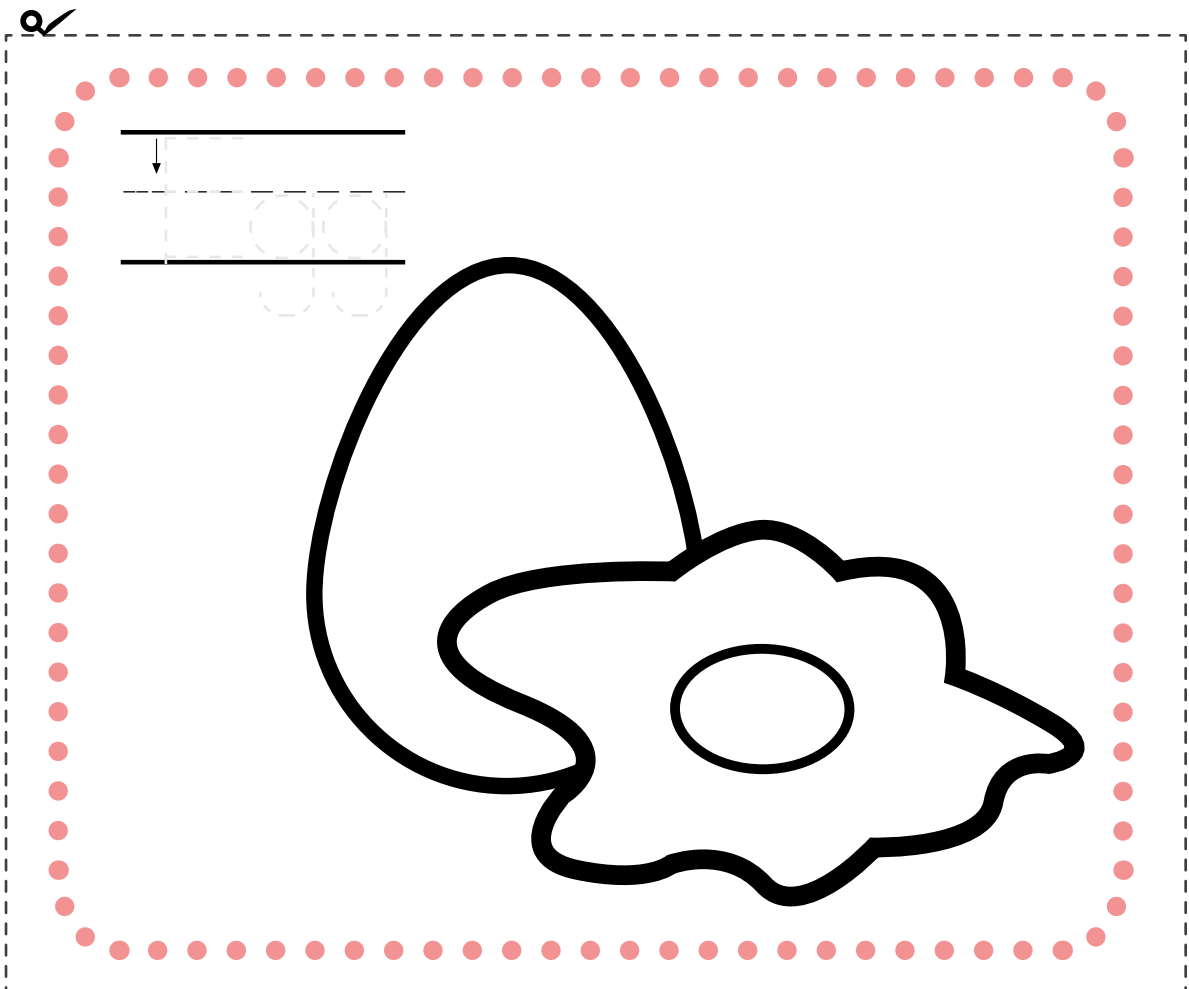
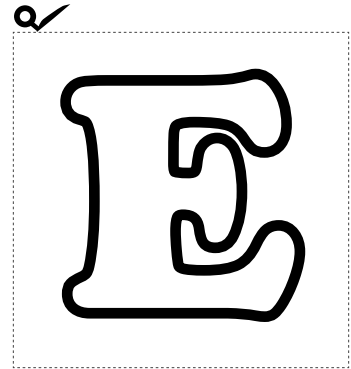
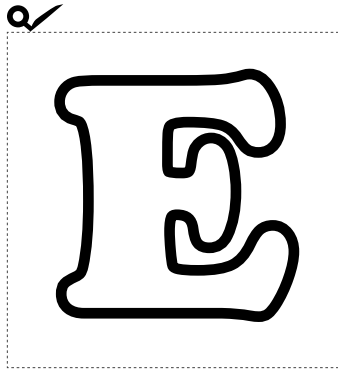
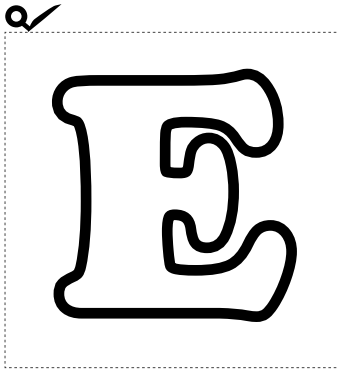



Have your kindergartner color in the pictures and trace the word along the dotted lines.

You can also reuse these flash cards by playing games with them:

- Mix them up and challenge your child to put them back in order
- Ask him to spell names, words, and sentences
- Mix them up, turn them face-down and play a memory matching game!

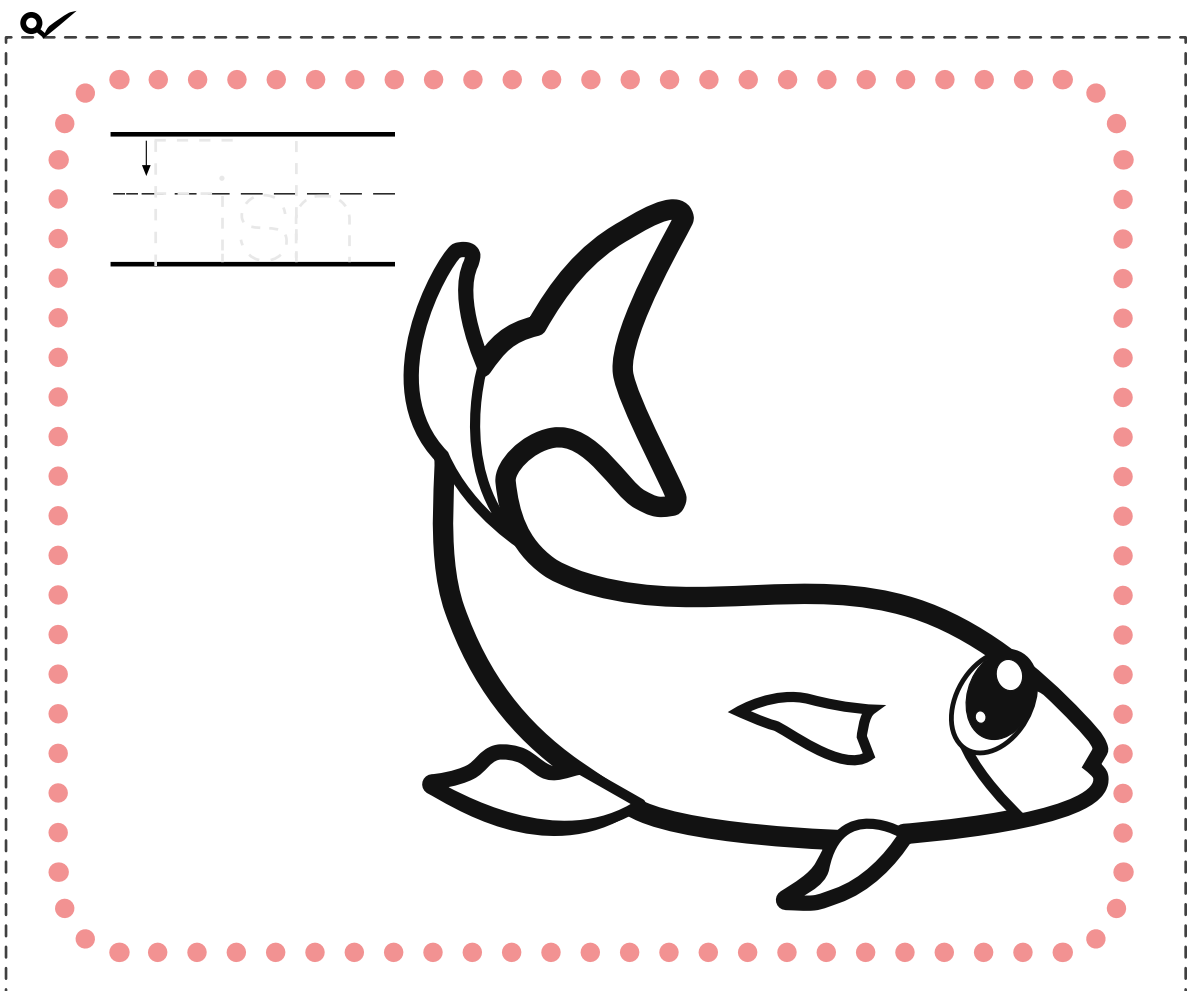
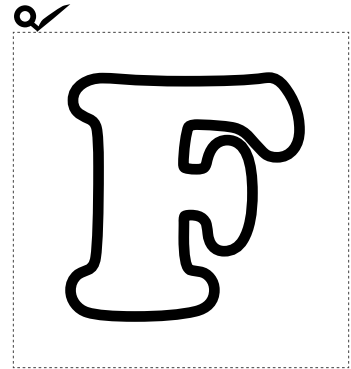
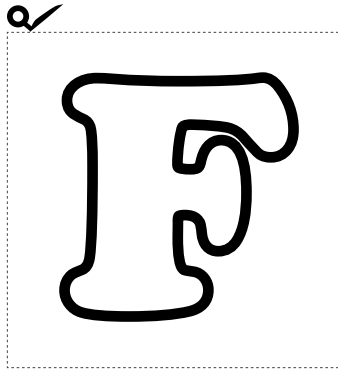
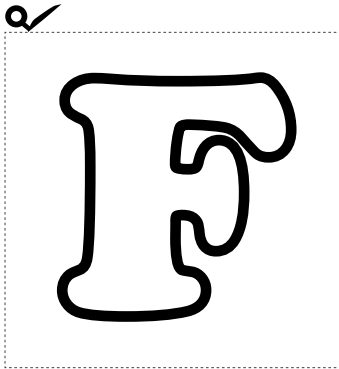

ABC FLASH CARDS

Have your kindergartner color in the pictures and trace the word along the dotted lines.

You can also reuse these flash cards by playing games with them:

- Mix them up and challenge your child to put them back in order
- Ask him to spell names, words, and sentences
- Mix them up, turn them face-down and play a memory matching game!

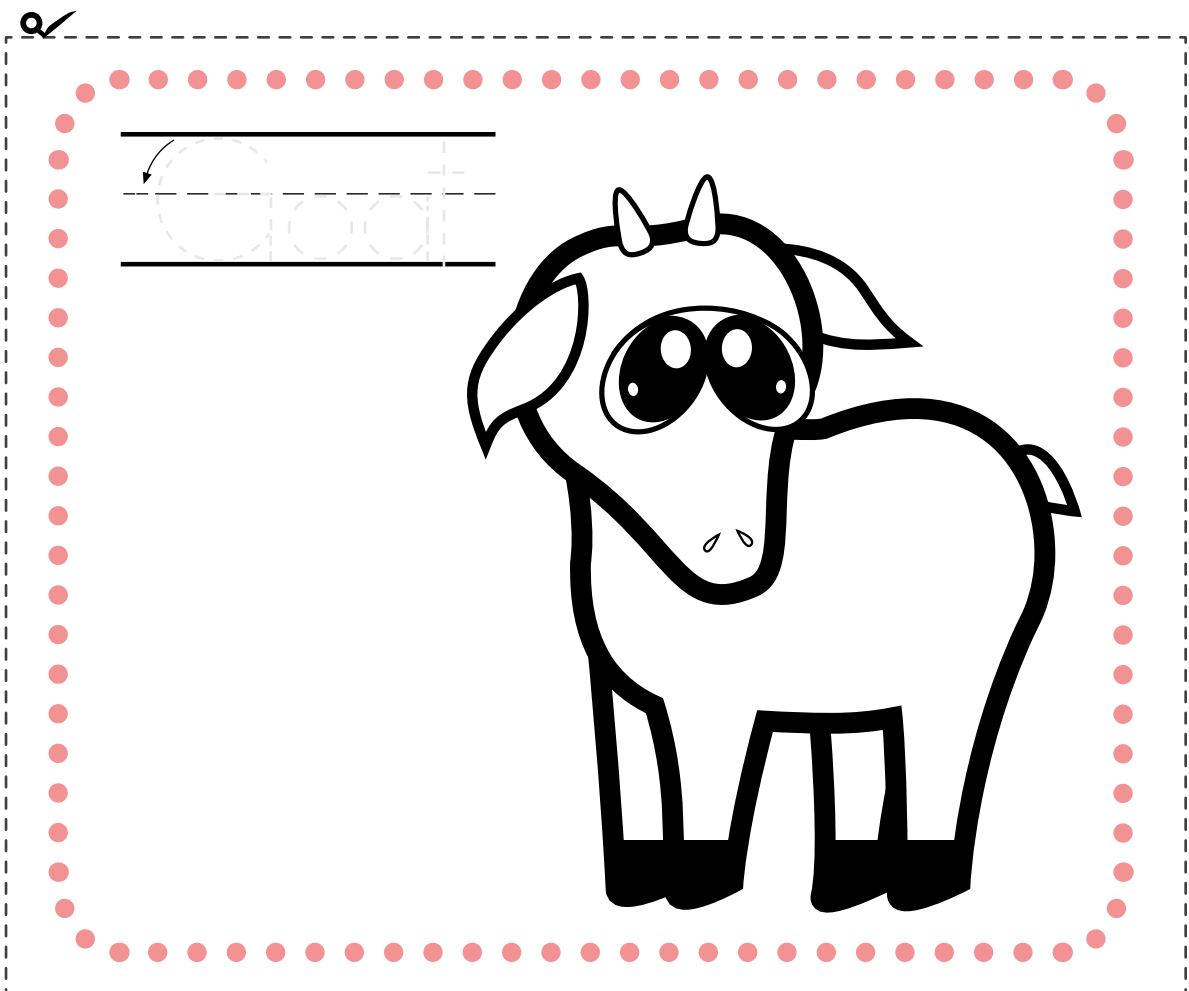
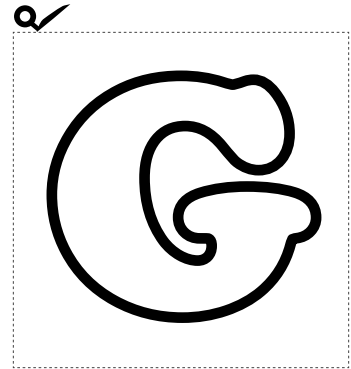
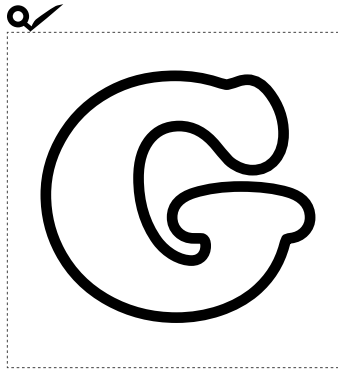
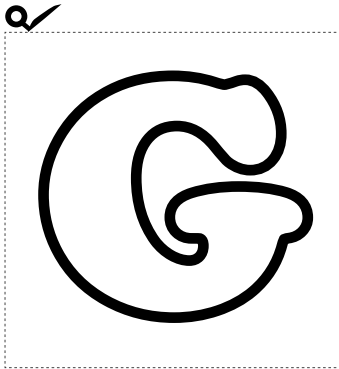

ABC FLASH CARDS

Have your kindergartner color in the pictures and trace the word along the dotted lines.

You can also reuse these flash cards by playing games with them:

- Mix them up and challenge your child to put them back in order
- Ask him to spell names, words, and sentences
- Mix them up, turn them face-down and play a memory matching game!

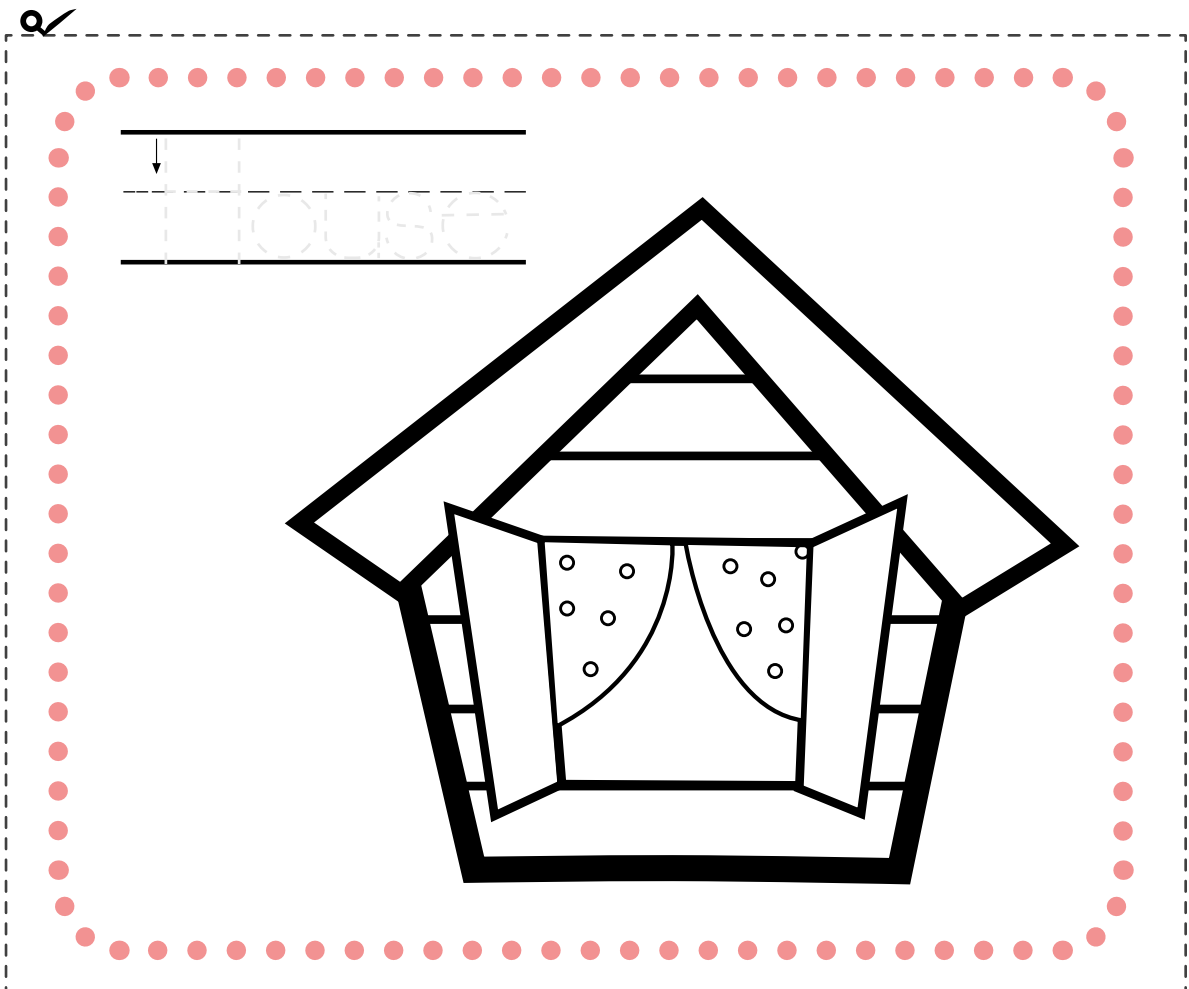
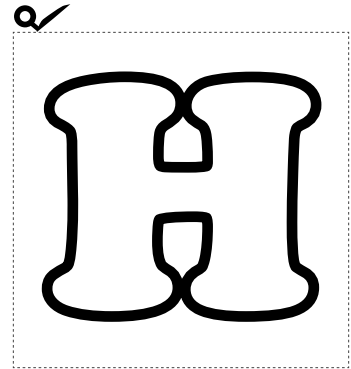
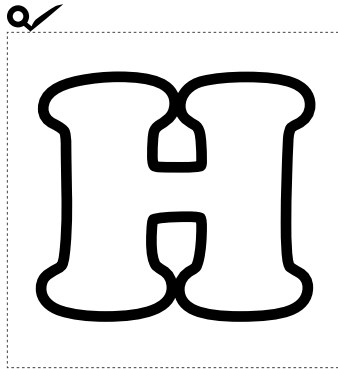
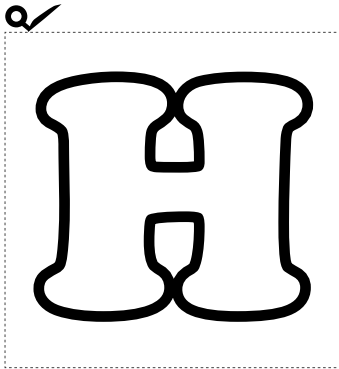

ABC FLASH CARDS

Have your kindergartner color in the pictures and trace the word along the dotted lines.

You can also reuse these flash cards by playing games with them:

- Mix them up and challenge your child to put them back in order
- Ask him to spell names, words, and sentences
- Mix them up, turn them face-down and play a memory matching game!

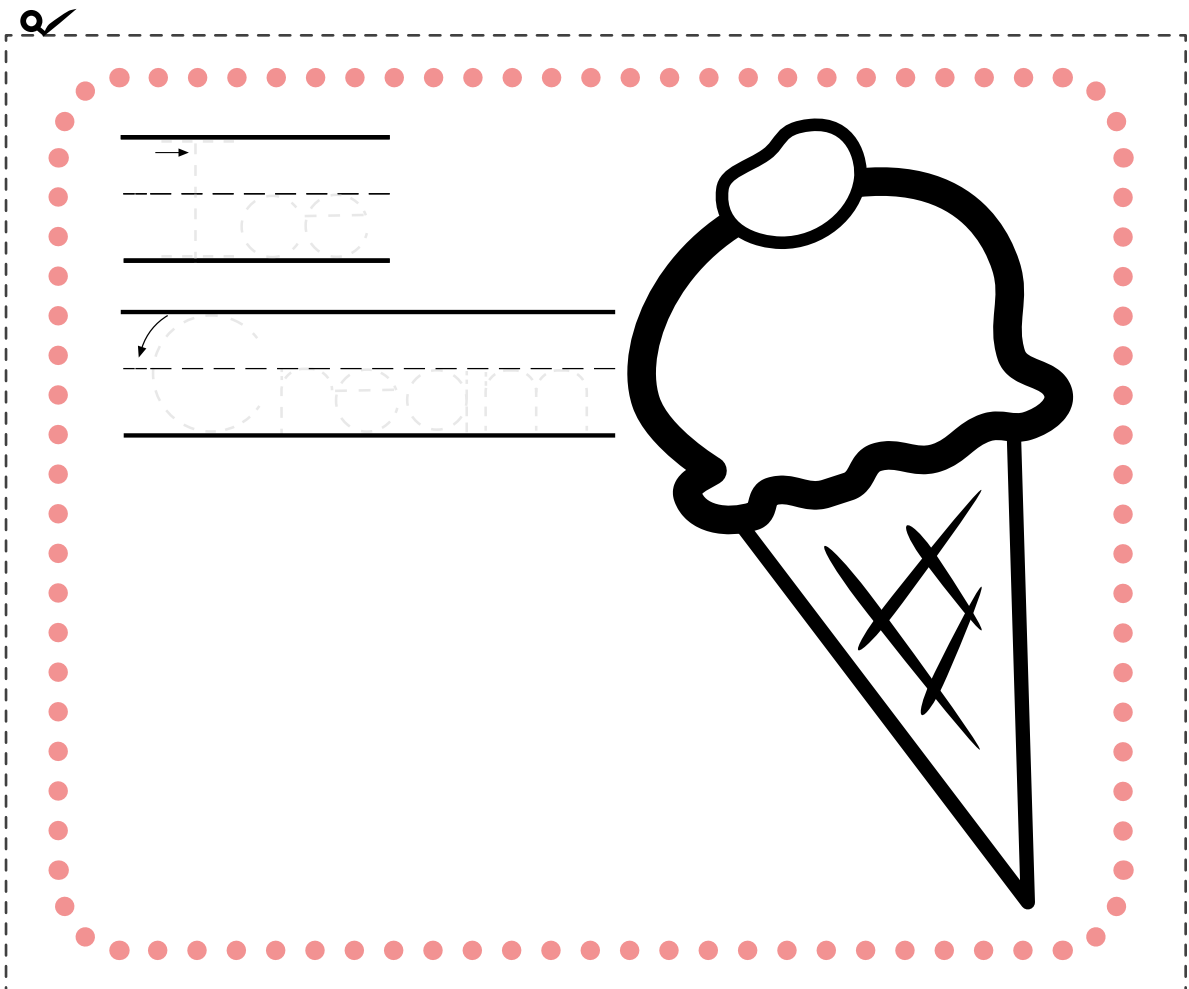
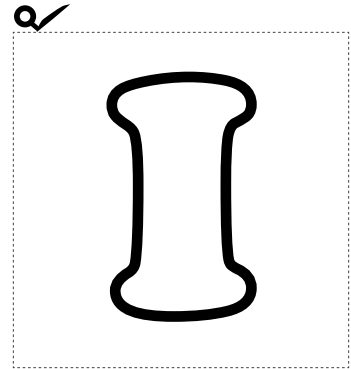
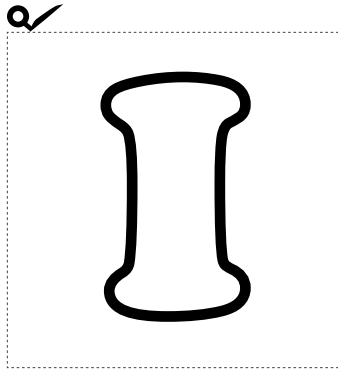
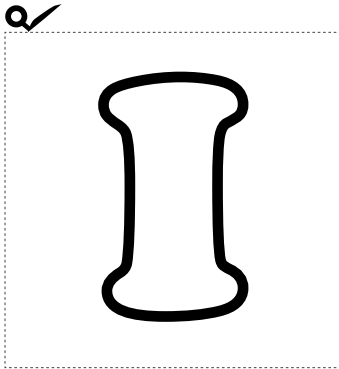



Have your kindergartner color in the pictures and trace the word along the dotted lines.

You can also reuse these flash cards by playing games with them:

- Mix them up and challenge your child to put them back in order
- Ask him to spell names, words, and sentences
- Mix them up, turn them face-down and play a memory matching game!

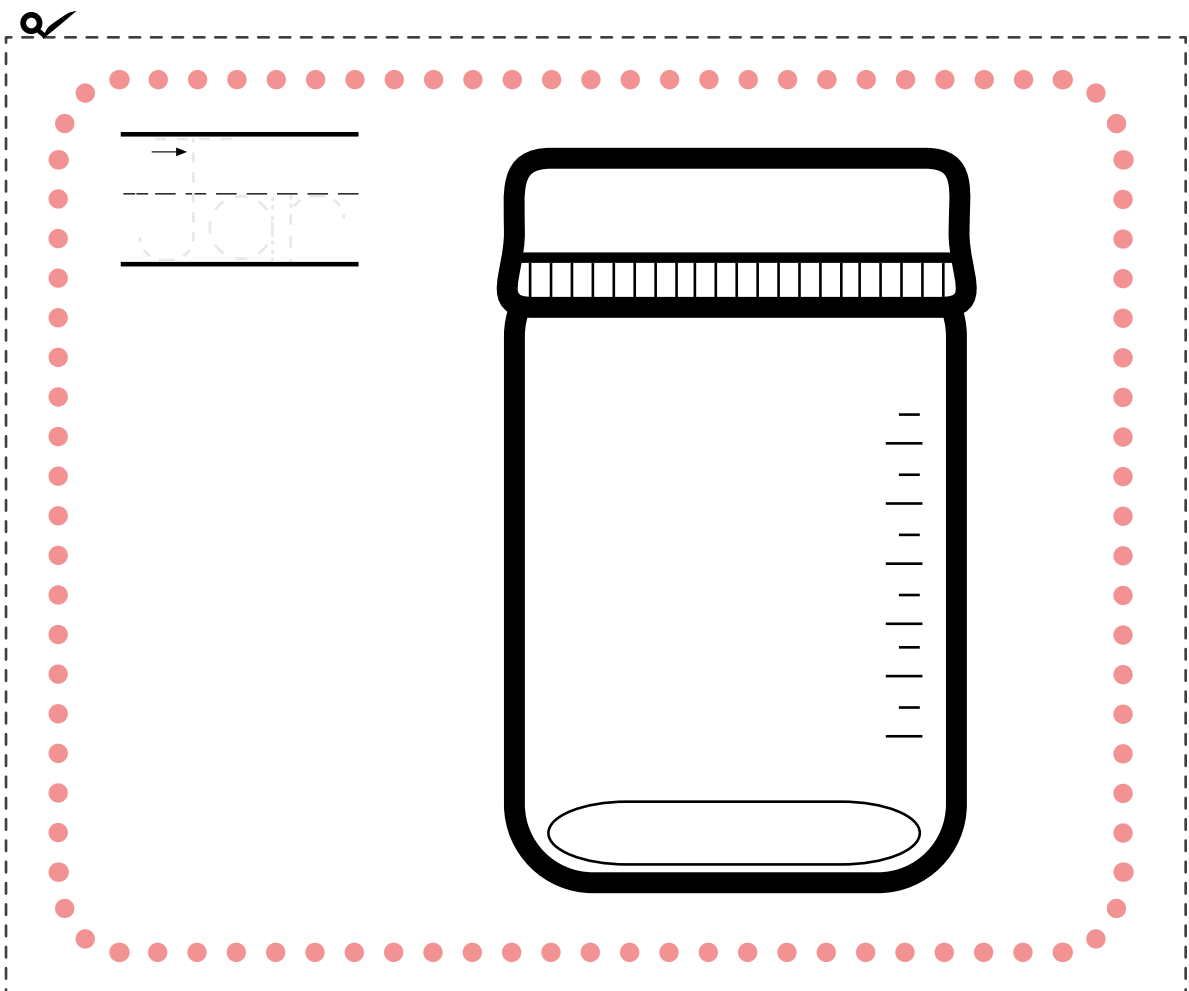
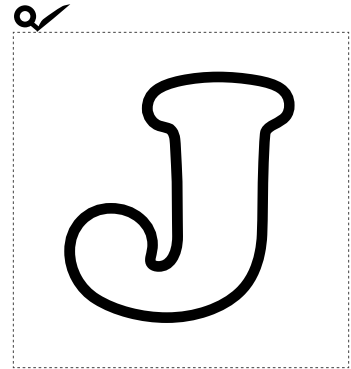
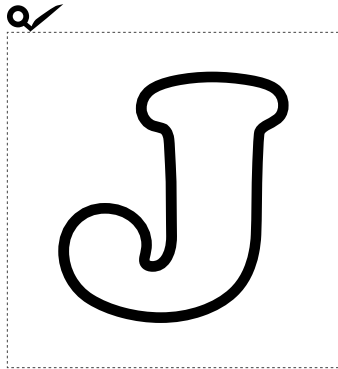
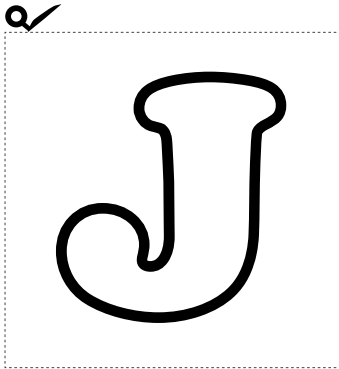



Have your kindergartner color in the pictures and trace the word along the dotted lines.

You can also reuse these flash cards by playing games with them:

- Mix them up and challenge your child to put them back in order
- Ask him to spell names, words, and sentences
- Mix them up, turn them face-down and play a memory matching game!

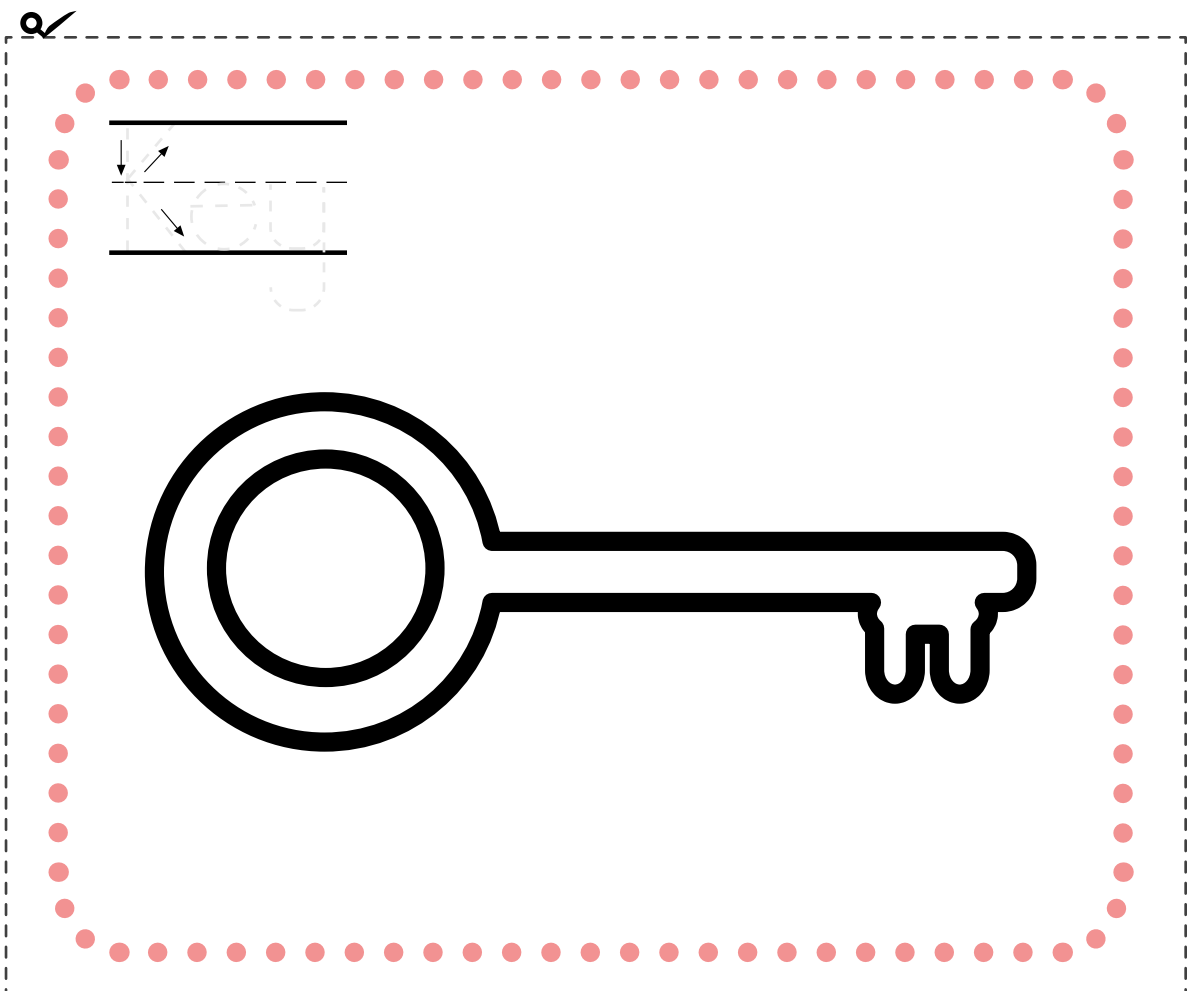
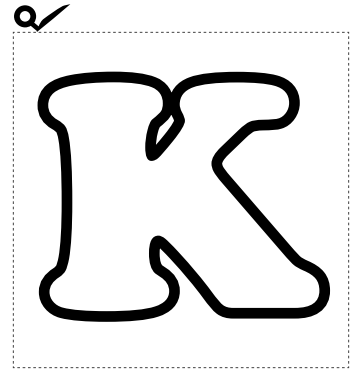
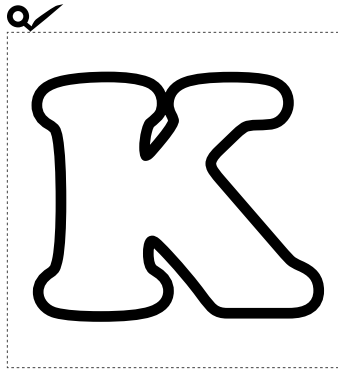
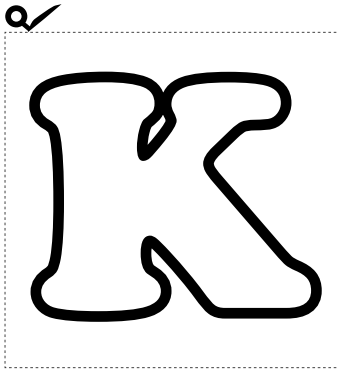



Have your kindergartner color in the pictures and trace the word along the dotted lines.

You can also reuse these flash cards by playing games with them:

- Mix them up and challenge your child to put them back in order
- Ask him to spell names, words, and sentences
- Mix them up, turn them face-down and play a memory matching game!

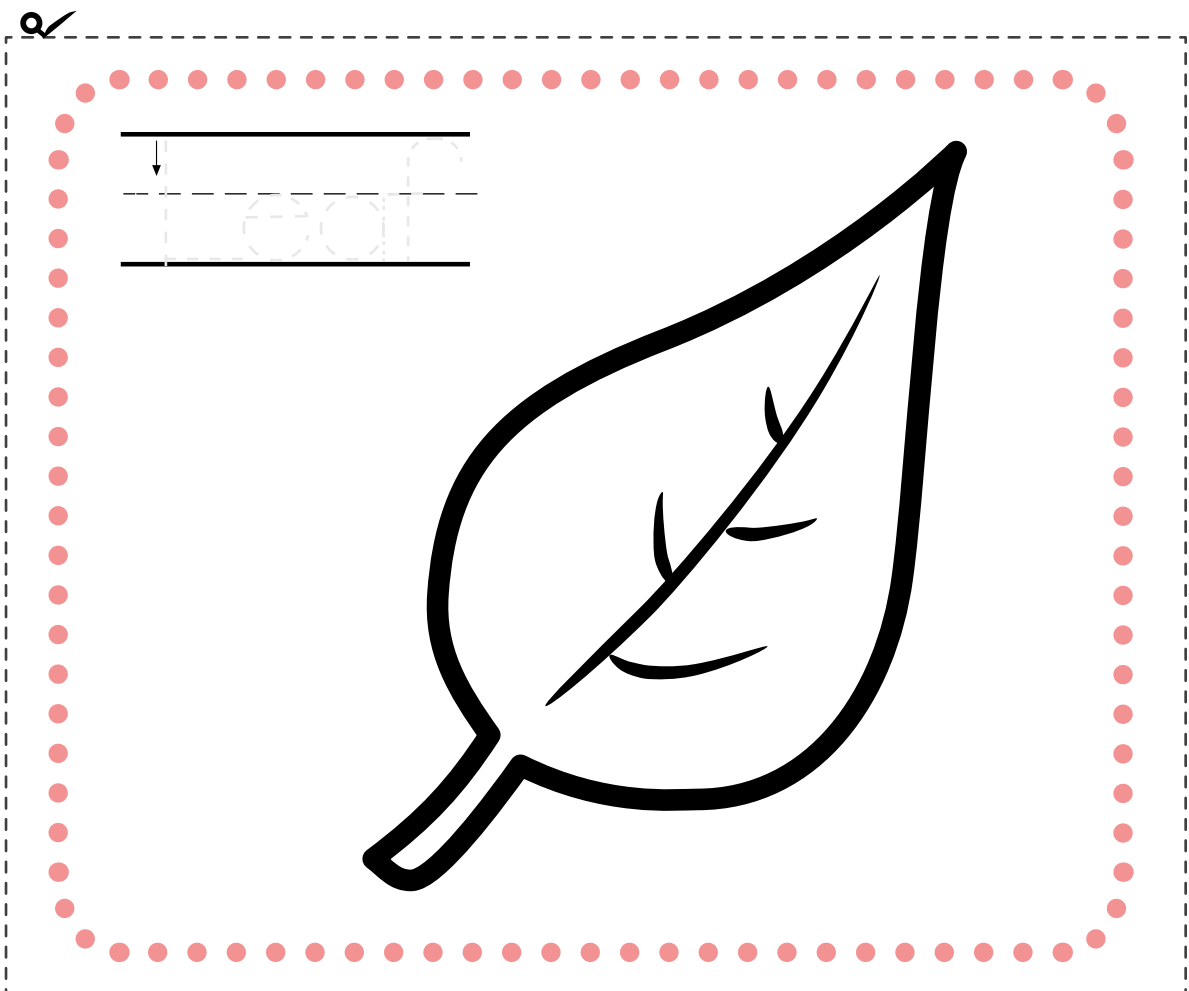
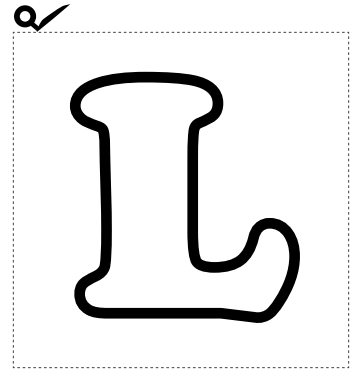
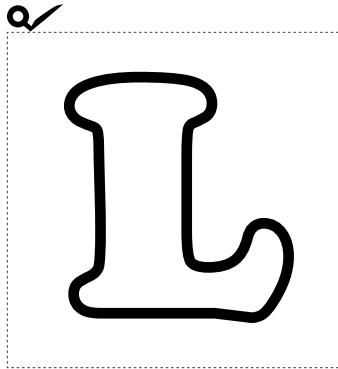
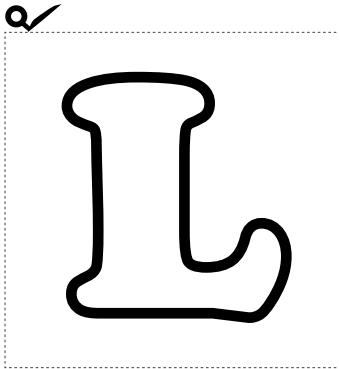

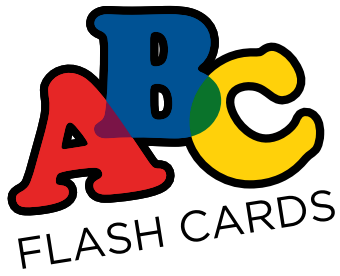

Have your kindergartner color in the pictures and trace the word along the dotted lines.

You can also reuse these flash cards by playing games with them:

- Mix them up and challenge your child to put them back in order
- Ask him to spell names, words, and sentences
- Mix them up, turn them face-down and play a memory matching game!

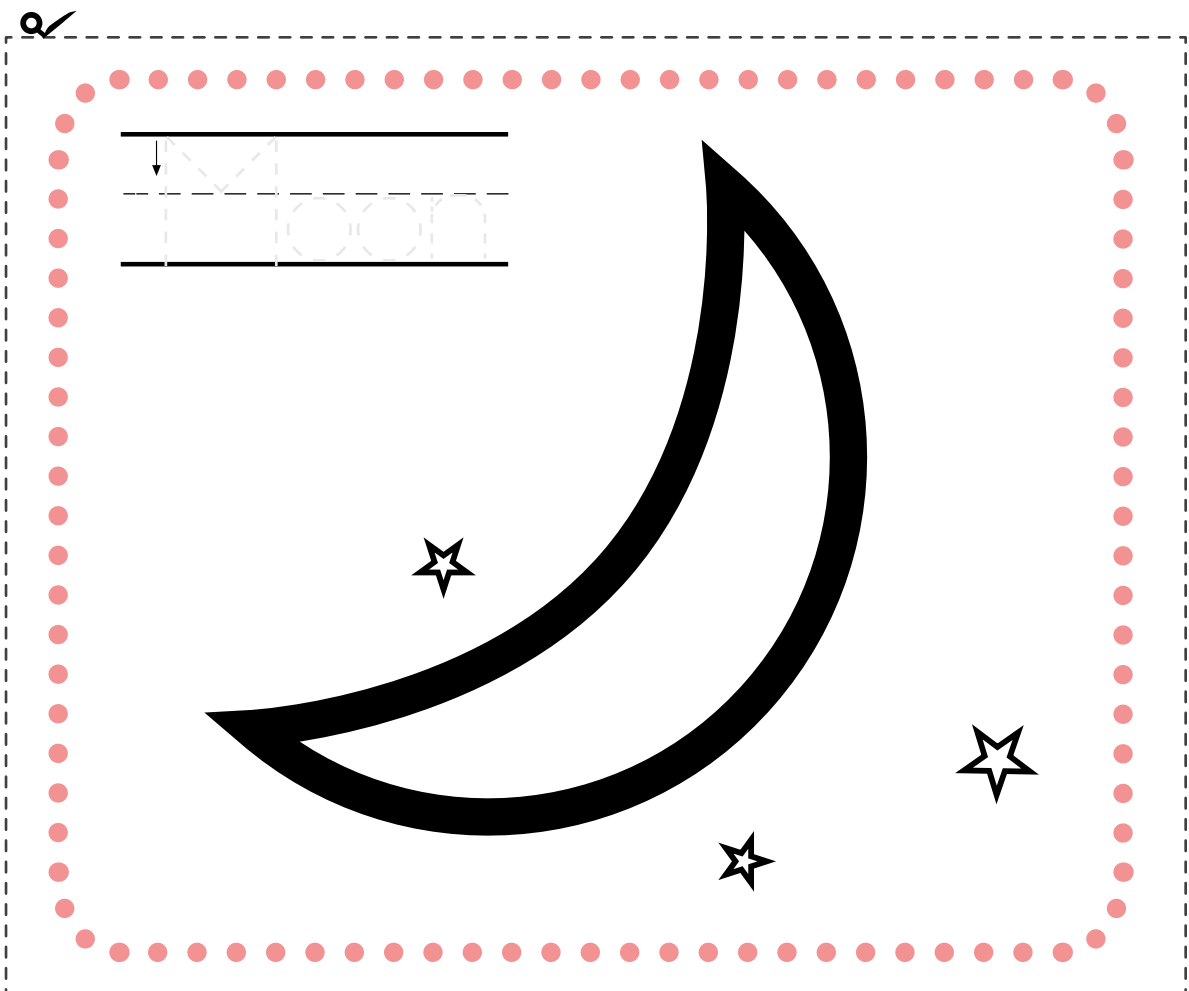
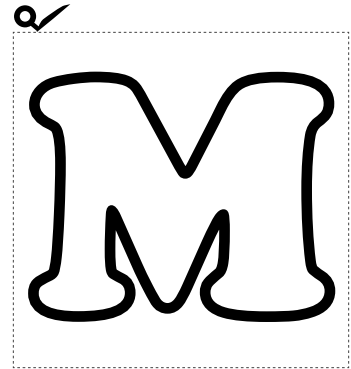
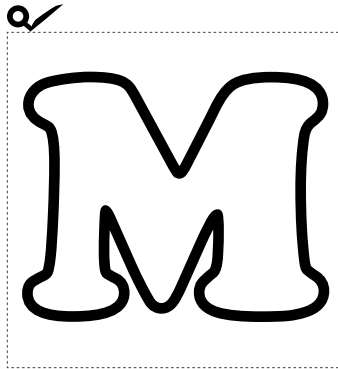
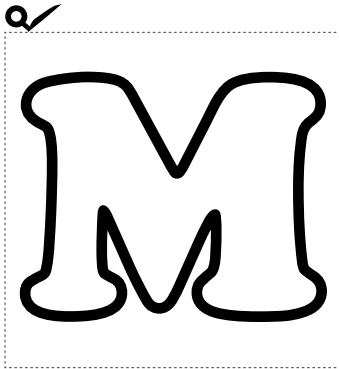



Have your kindergartner color in the pictures and trace the word along the dotted lines.

You can also reuse these flash cards by playing games with them:

- Mix them up and challenge your child to put them back in order
- Ask him to spell names, words, and sentences
- Mix them up, turn them face-down and play a memory matching game!

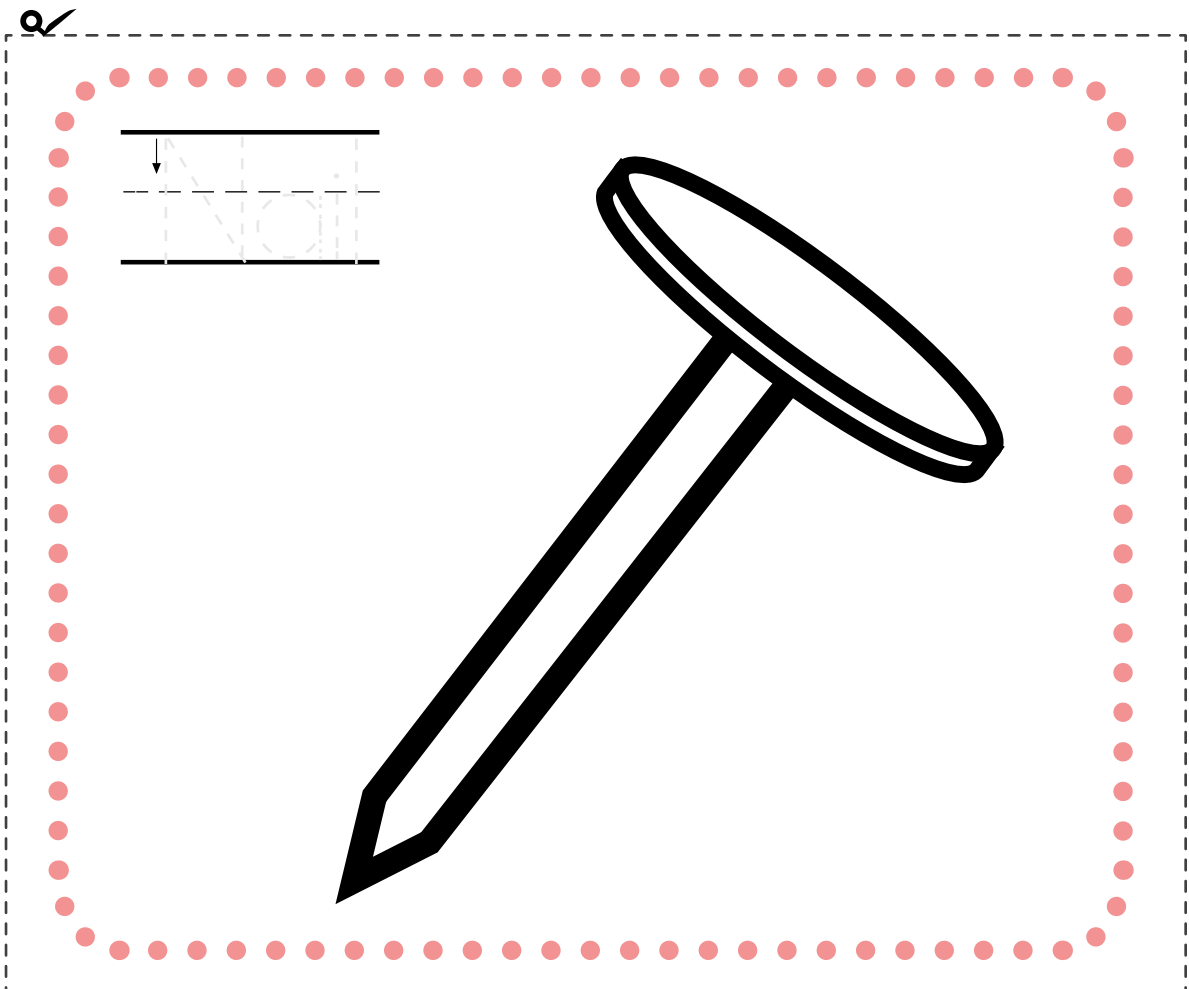
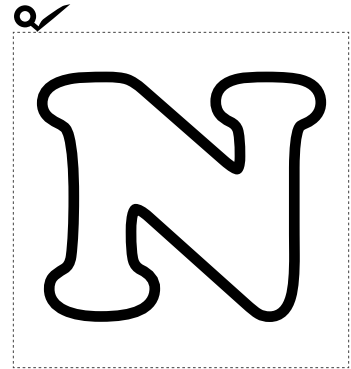
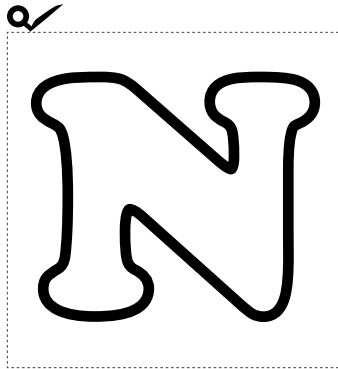
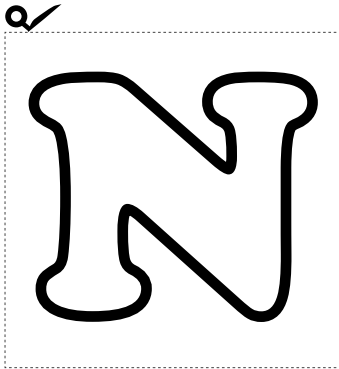

ABC FLASH CARDS

Have your kindergartner color in the pictures and trace the word along the dotted lines.

You can also reuse these flash cards by playing games with them:

- Mix them up and challenge your child to put them back in order
- Ask him to spell names, words, and sentences
- Mix them up, turn them face-down and play a memory matching game!

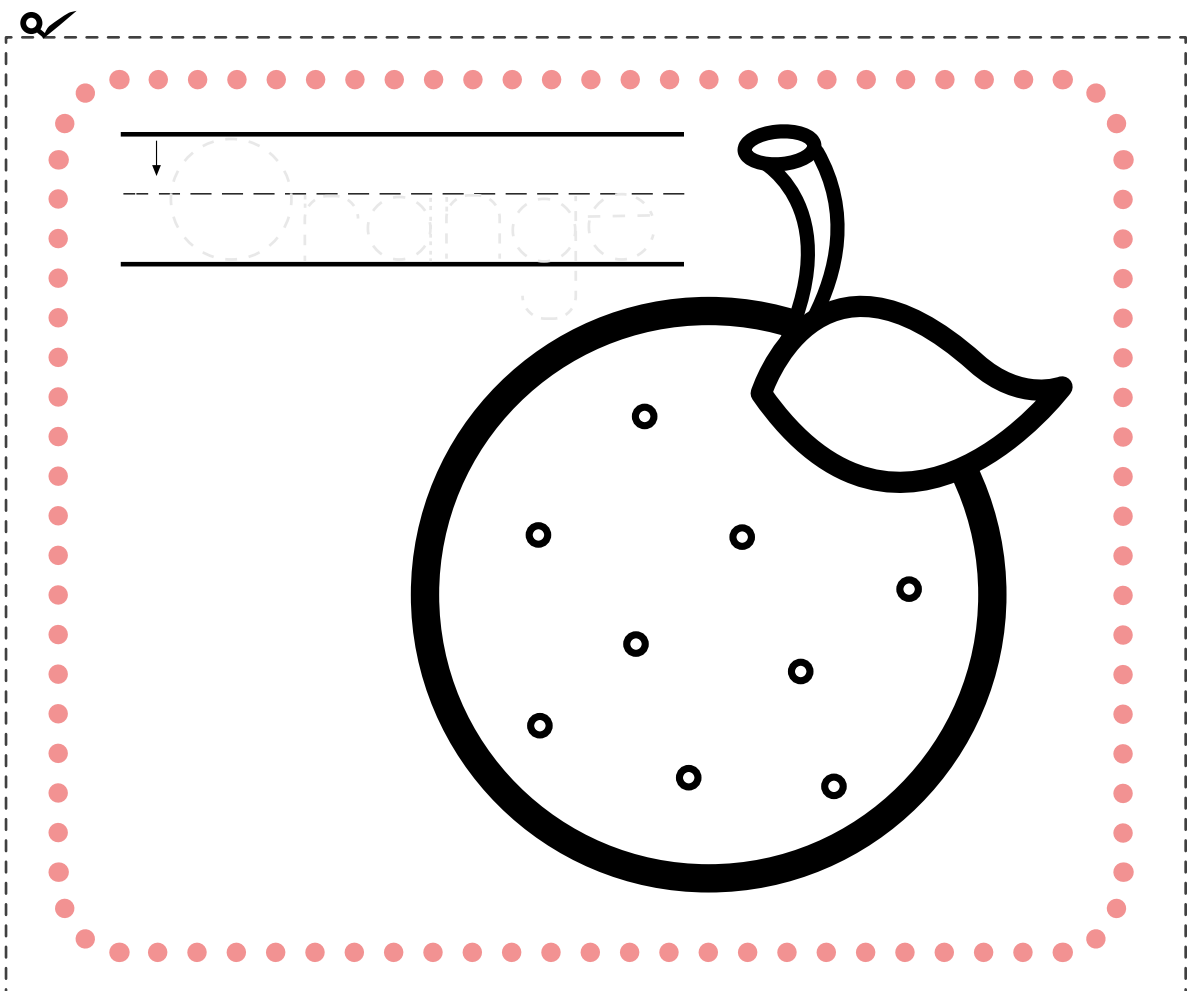
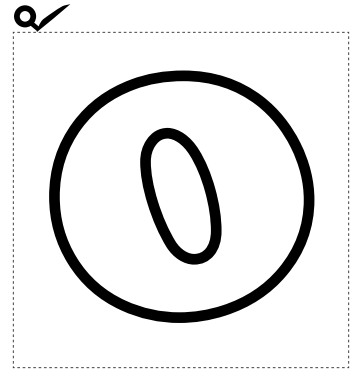
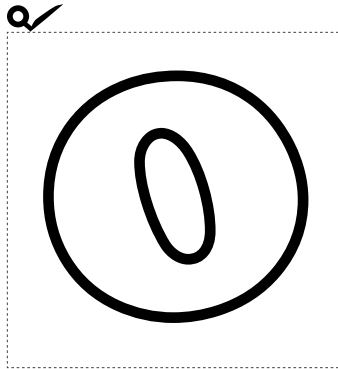
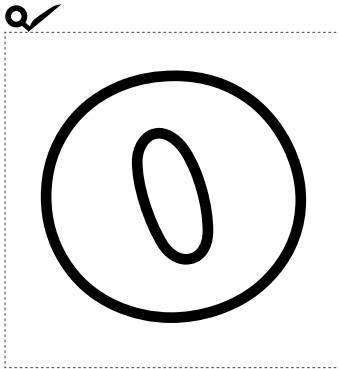

ABC FLASH CARDS

Have your kindergartner color in the pictures and trace the word along the dotted lines.

You can also reuse these flash cards by playing games with them:

- Mix them up and challenge your child to put them back in order
- Ask him to spell names, words, and sentences
- Mix them up, turn them face-down and play a memory matching game!

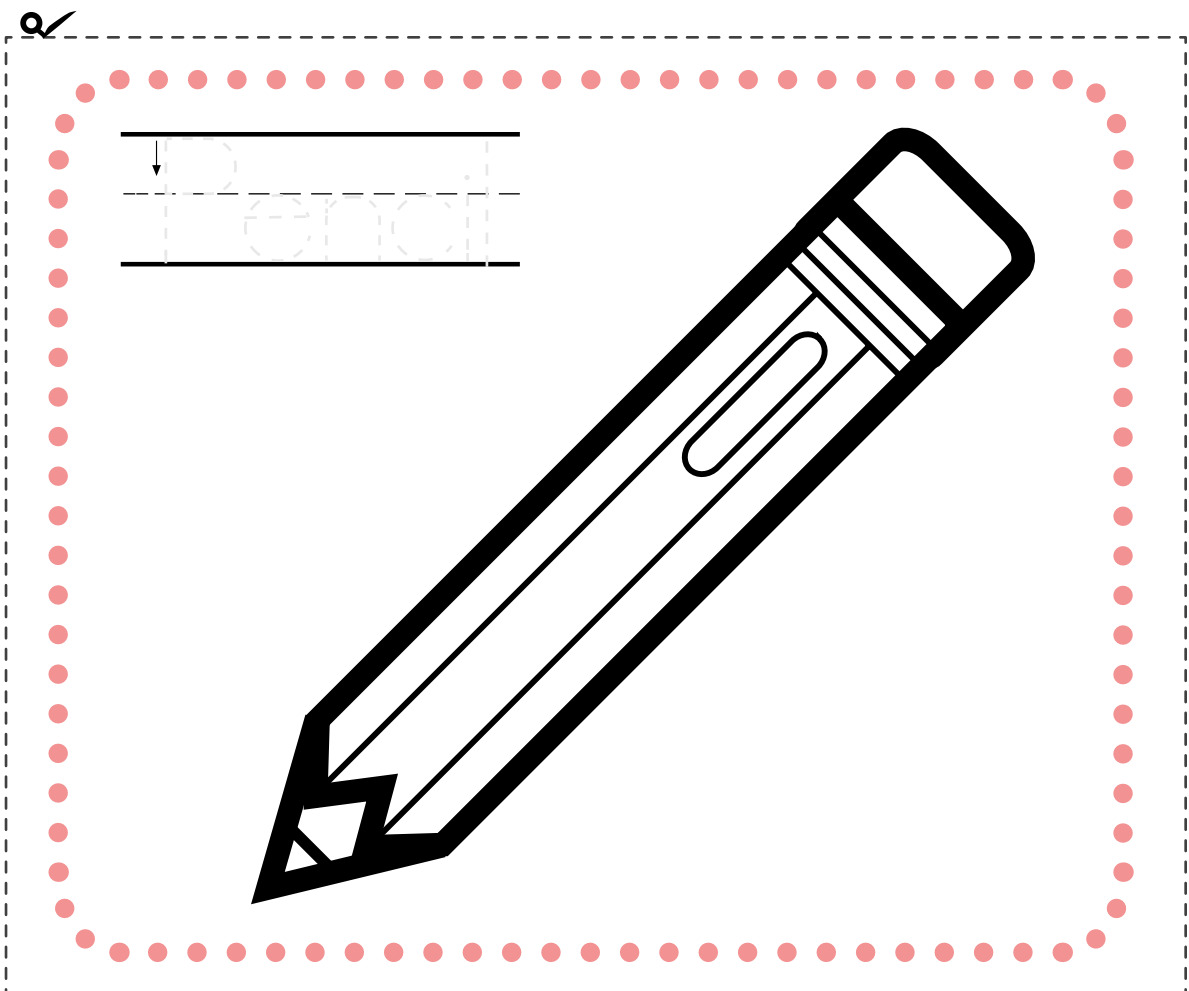
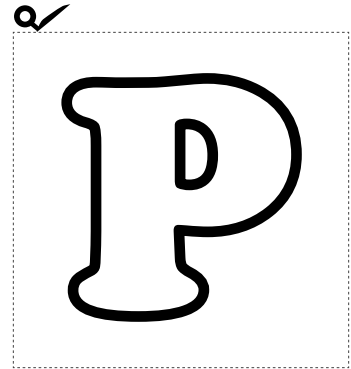
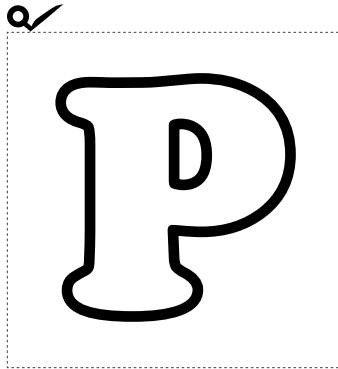
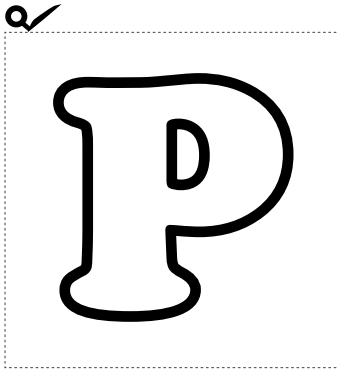

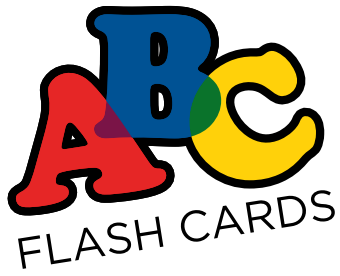

Have your kindergartner color in the pictures and trace the word along the dotted lines.

You can also reuse these flash cards by playing games with them:

- Mix them up and challenge your child to put them back in order
- Ask him to spell names, words, and sentences
- Mix them up, turn them face-down and play a memory matching game!

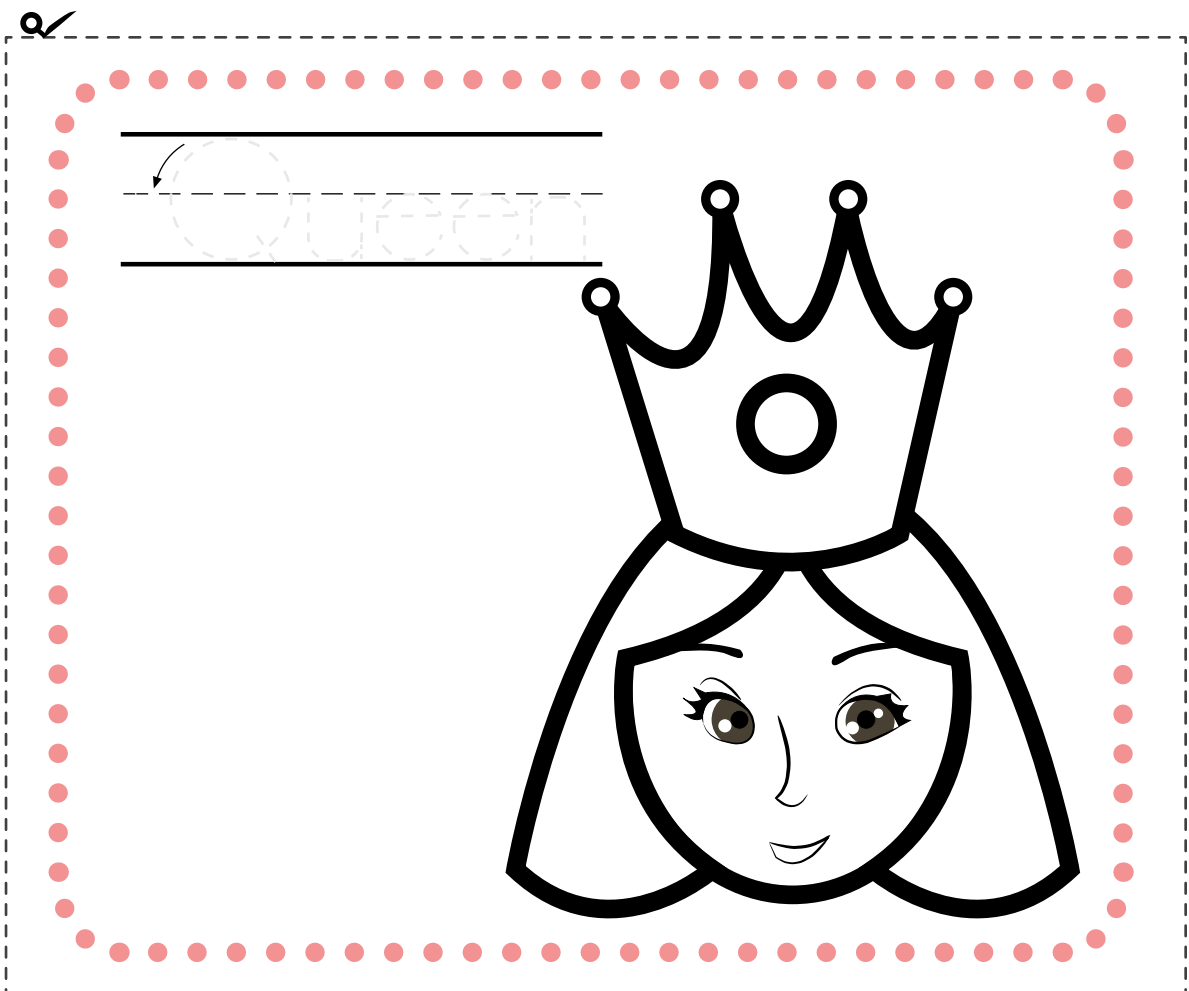
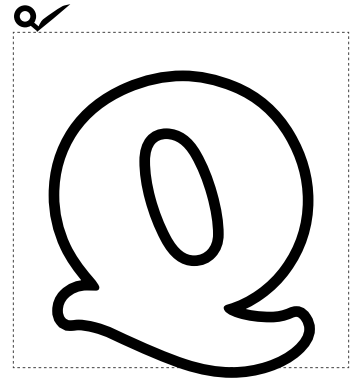
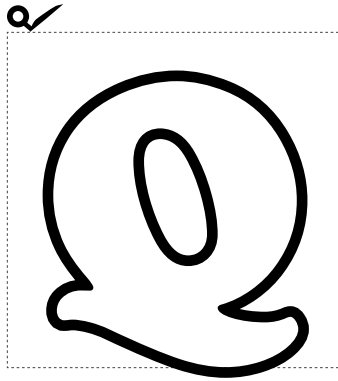
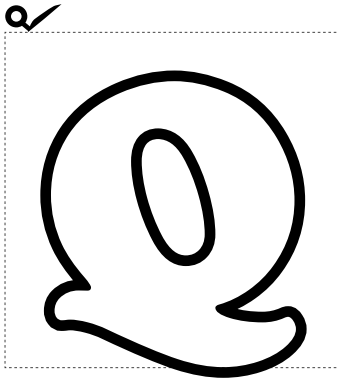



Have your kindergartner color in the pictures and trace the word along the dotted lines.

You can also reuse these flash cards by playing games with them:

- Mix them up and challenge your child to put them back in order
- Ask him to spell names, words, and sentences
- Mix them up, turn them face-down and play a memory matching game!

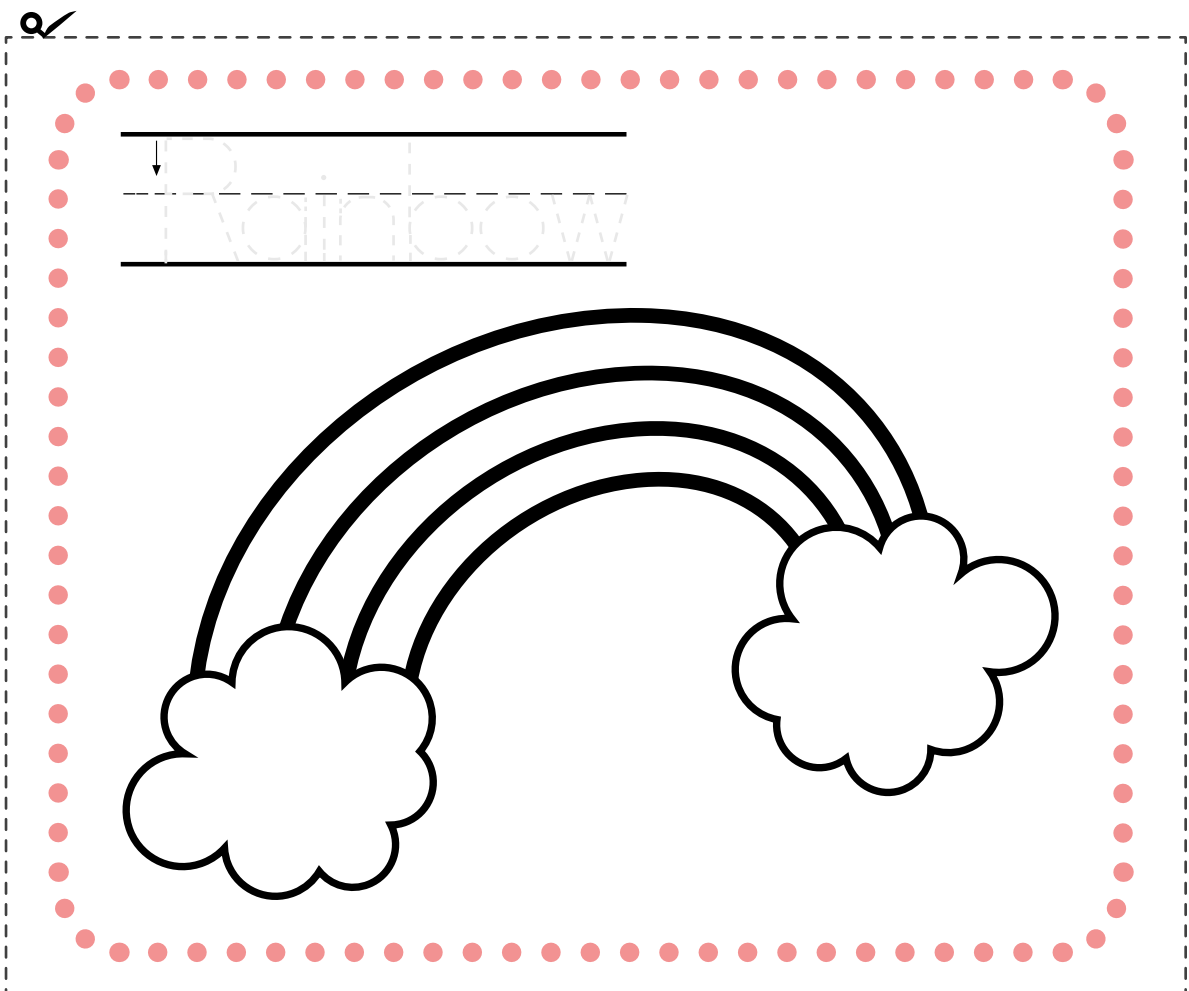
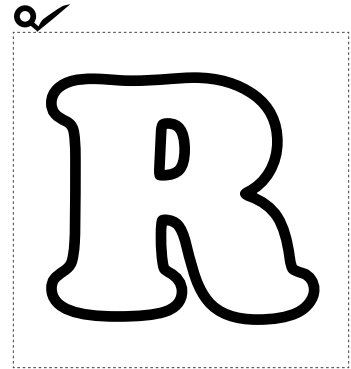
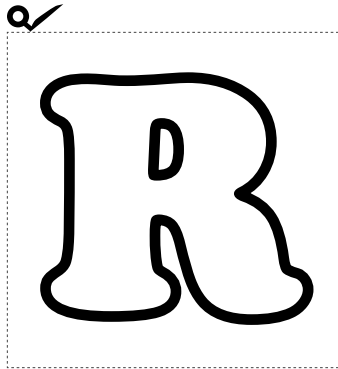
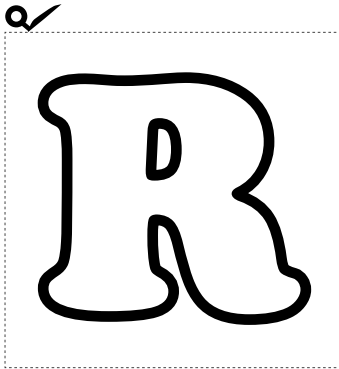

ABC FLASH CARDS

Have your kindergartner color in the pictures and trace the word along the dotted lines.

You can also reuse these flash cards by playing games with them:

- Mix them up and challenge your child to put them back in order
- Ask him to spell names, words, and sentences
- Mix them up, turn them face-down and play a memory matching game!

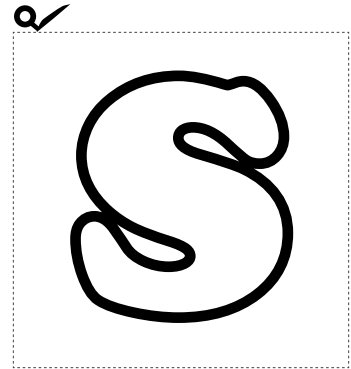
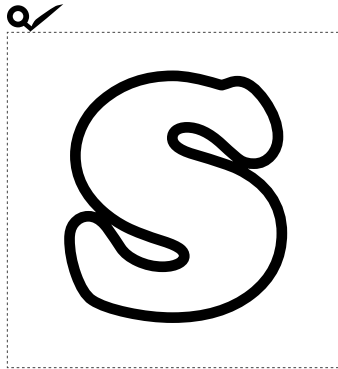
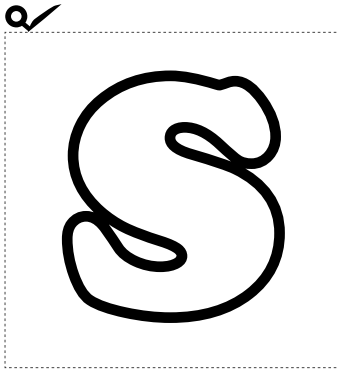

ABC FLASH CARDS

Have your kindergartner color in the pictures and trace the word along the dotted lines.

You can also reuse these flash cards by playing games with them:

- Mix them up and challenge your child to put them back in order
- Ask him to spell names, words, and sentences
- Mix them up, turn them face-down and play a memory matching game!

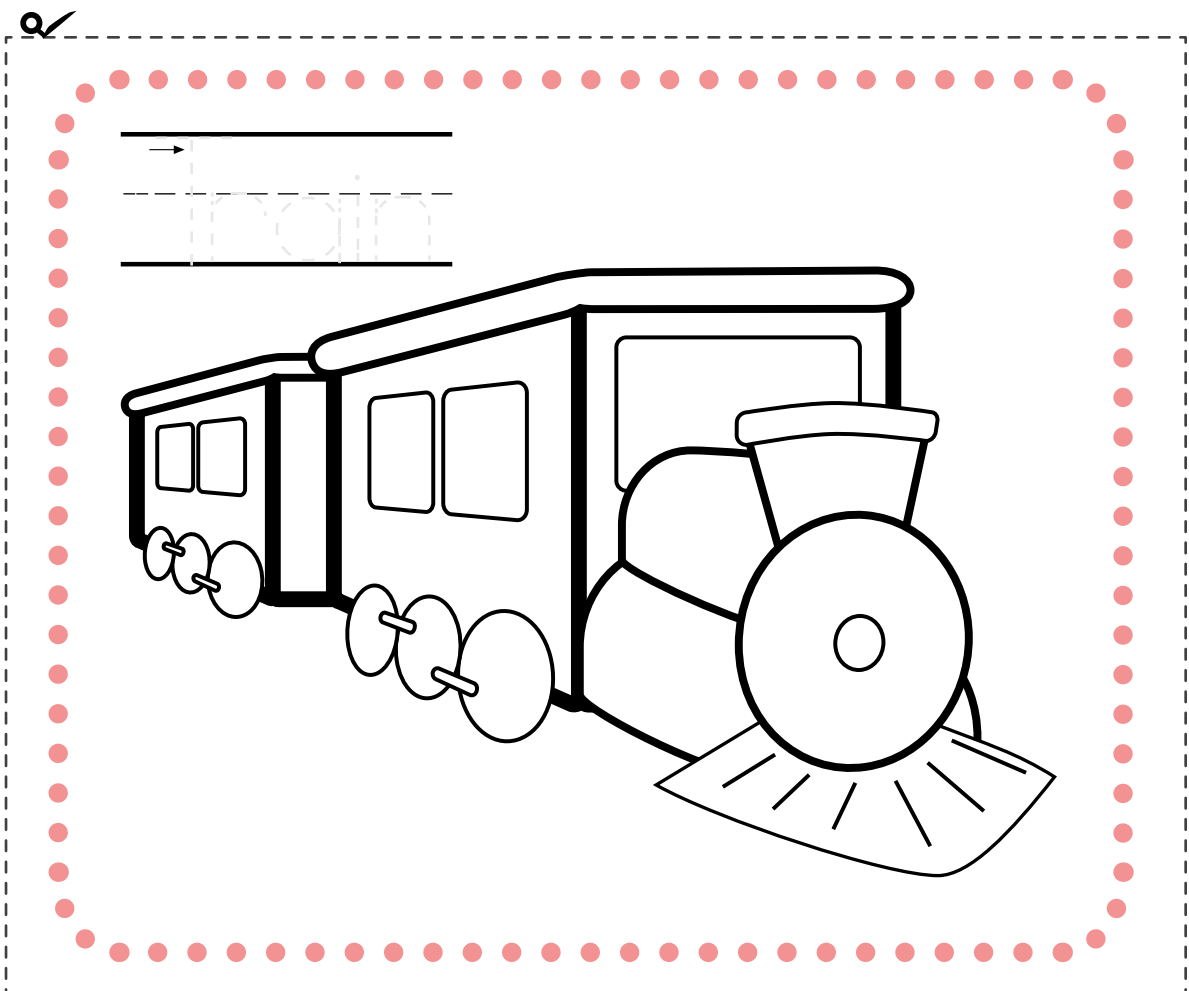
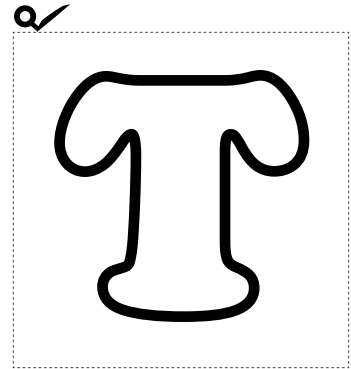
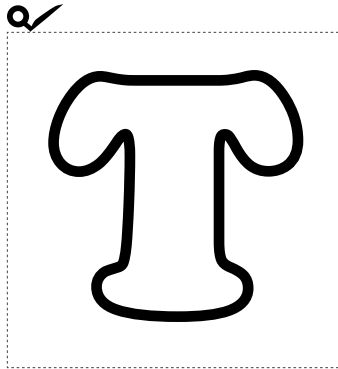
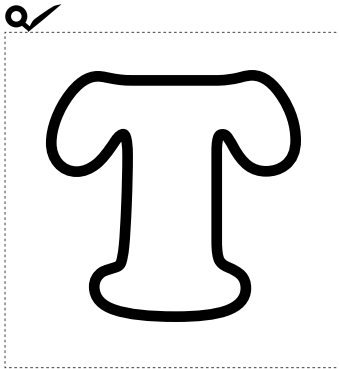

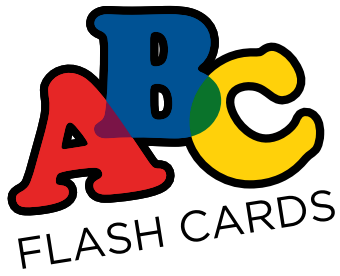

Have your kindergartner color in the pictures and trace the word along the dotted lines.

You can also reuse these flash cards by playing games with them:

- Mix them up and challenge your child to put them back in order
- Ask him to spell names, words, and sentences
- Mix them up, turn them face-down and play a memory matching game!

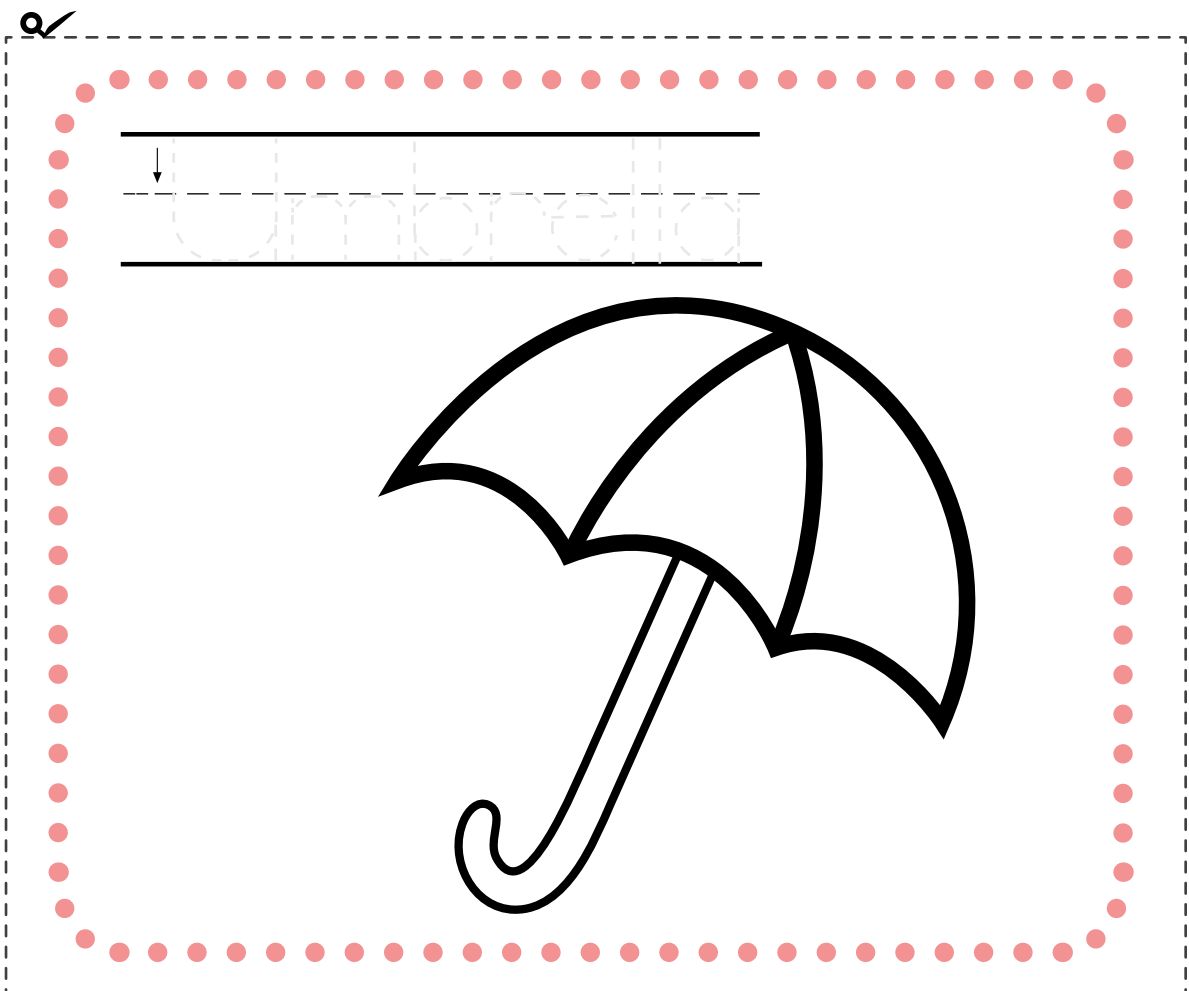
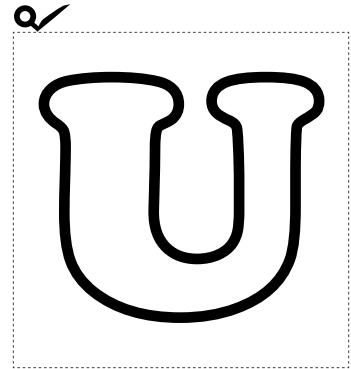
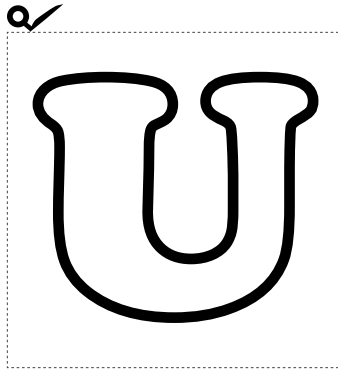
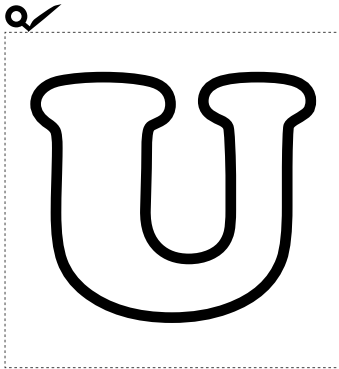

ABC FLASH CARDS

Have your kindergartner color in the pictures and trace the word along the dotted lines.

You can also reuse these flash cards by playing games with them:

- Mix them up and challenge your child to put them back in order
- Ask him to spell names, words, and sentences
- Mix them up, turn them face-down and play a memory matching game!

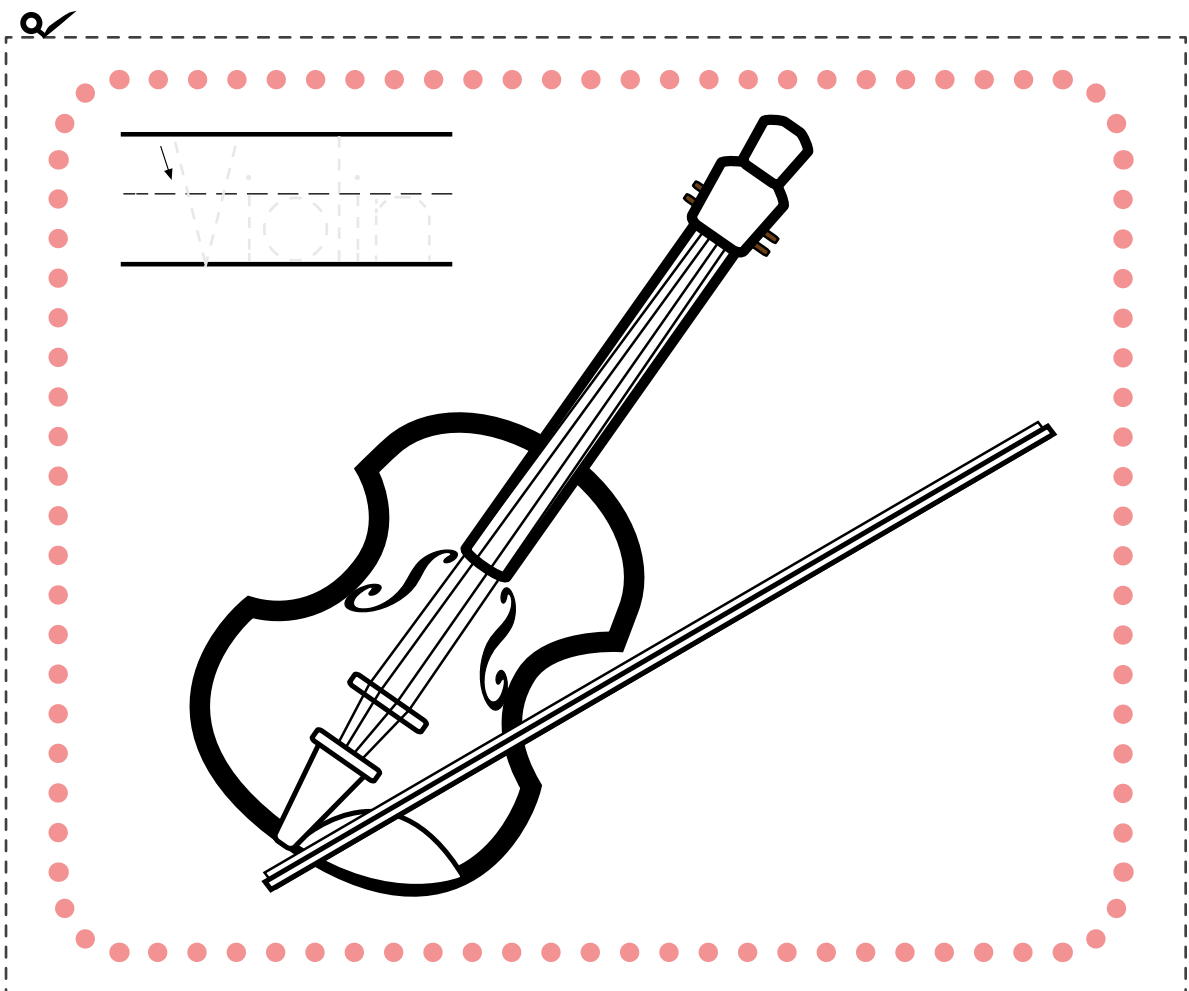

ABC FLASH CARDS

Have your kindergartner color in the pictures and trace the word along the dotted lines.

You can also reuse these flash cards by playing games with them:

- Mix them up and challenge your child to put them back in order
- Ask him to spell names, words, and sentences
- Mix them up, turn them face-down and play a memory matching game!

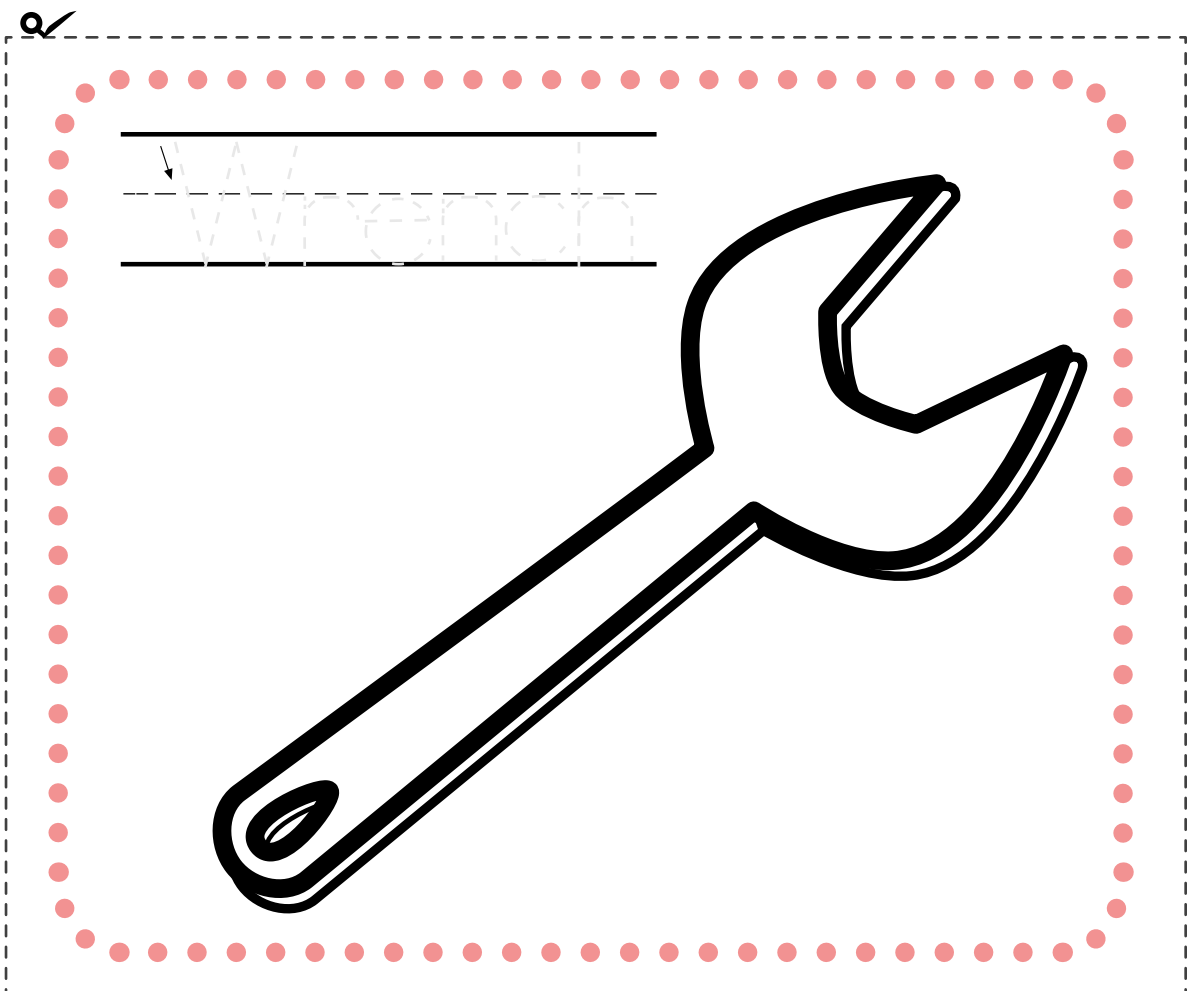
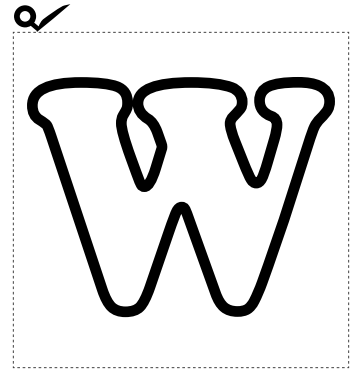
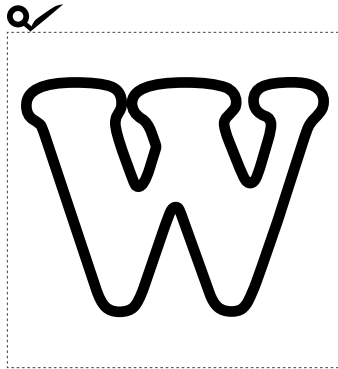
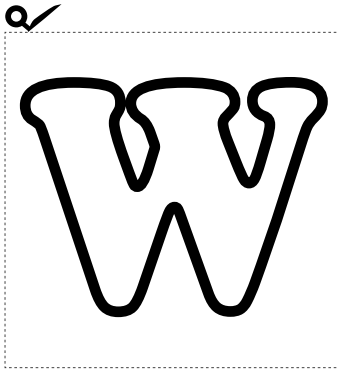

ABC FLASH CARDS

Have your kindergartner color in the pictures and trace the word along the dotted lines.

You can also reuse these flash cards by playing games with them:

- Mix them up and challenge your child to put them back in order
- Ask him to spell names, words, and sentences
- Mix them up, turn them face-down and play a memory matching game!

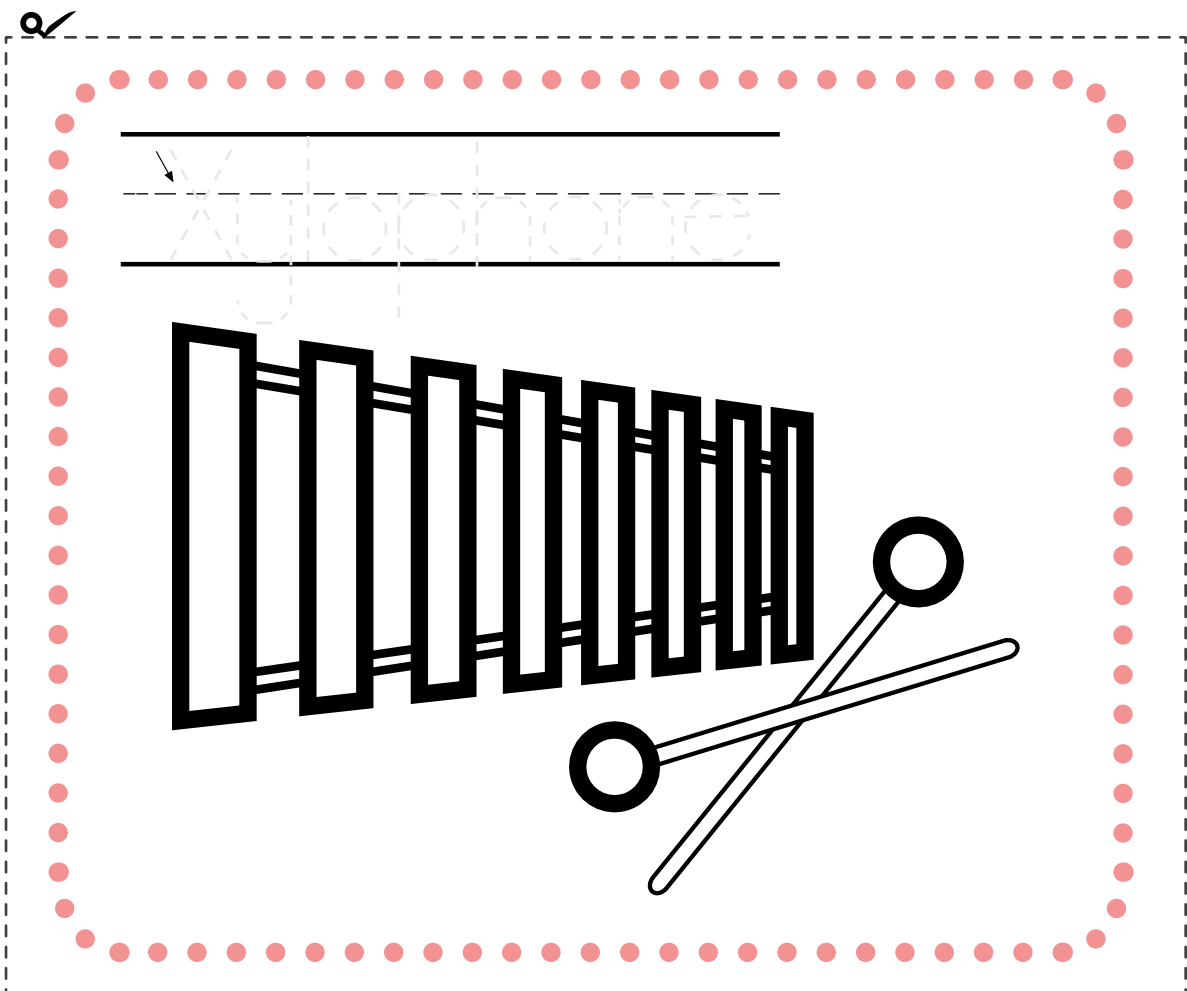
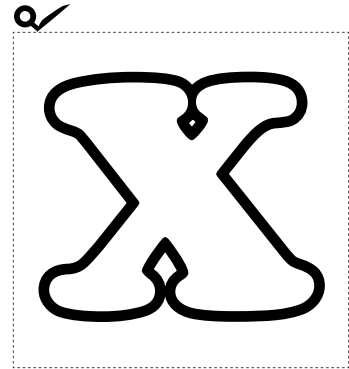
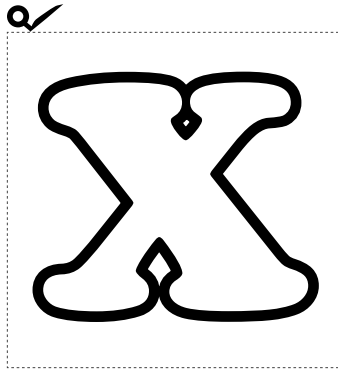
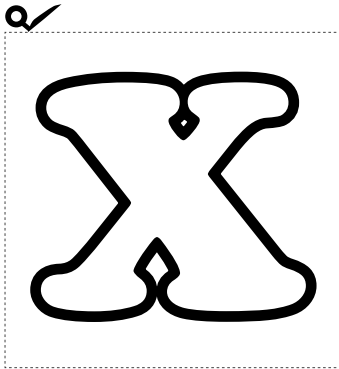

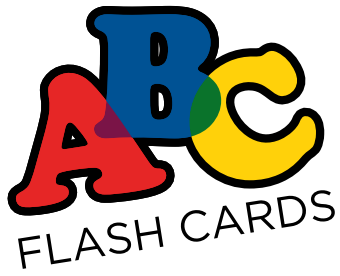

Have your kindergartner color in the pictures and trace the word along the dotted lines.

You can also reuse these flash cards by playing games with them:

- Mix them up and challenge your child to put them back in order
- Ask him to spell names, words, and sentences
- Mix them up, turn them face-down and play a memory matching game!

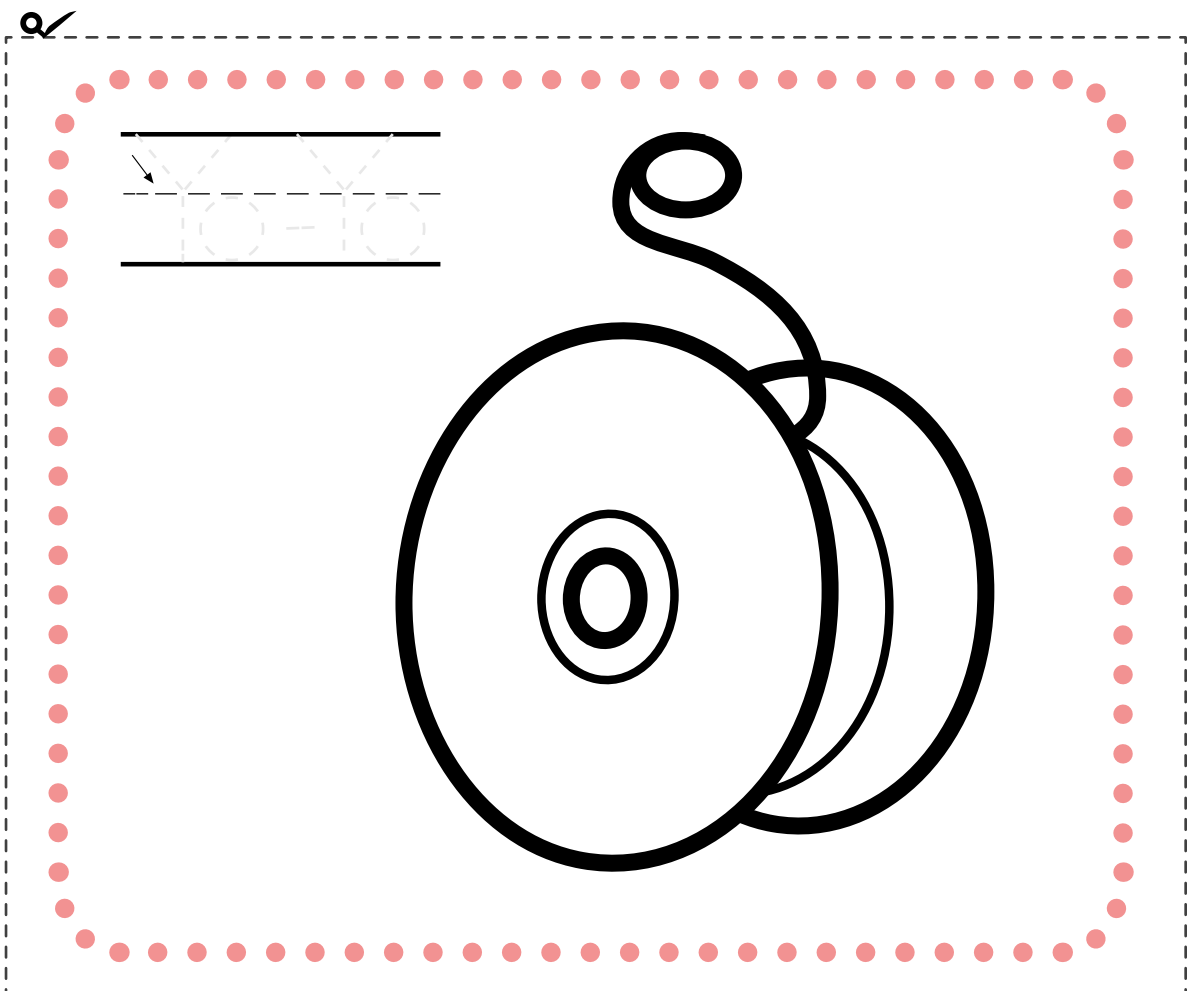
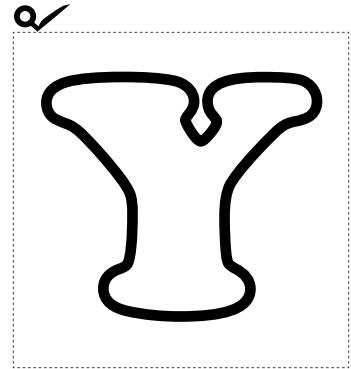
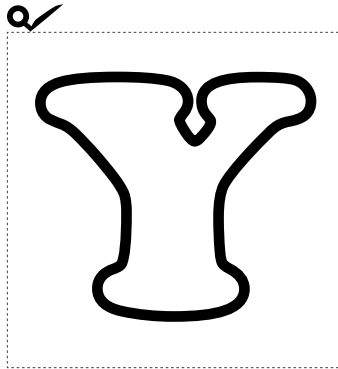
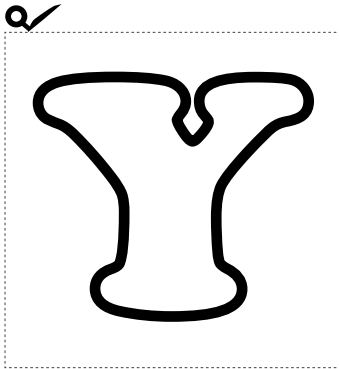

ABC FLASH CARDS

Have your kindergartner color in the pictures and trace the word along the dotted lines.

You can also reuse these flash cards by playing games with them:

- Mix them up and challenge your child to put them back in order
- Ask him to spell names, words, and sentences
- Mix them up, turn them face-down and play a memory matching game!

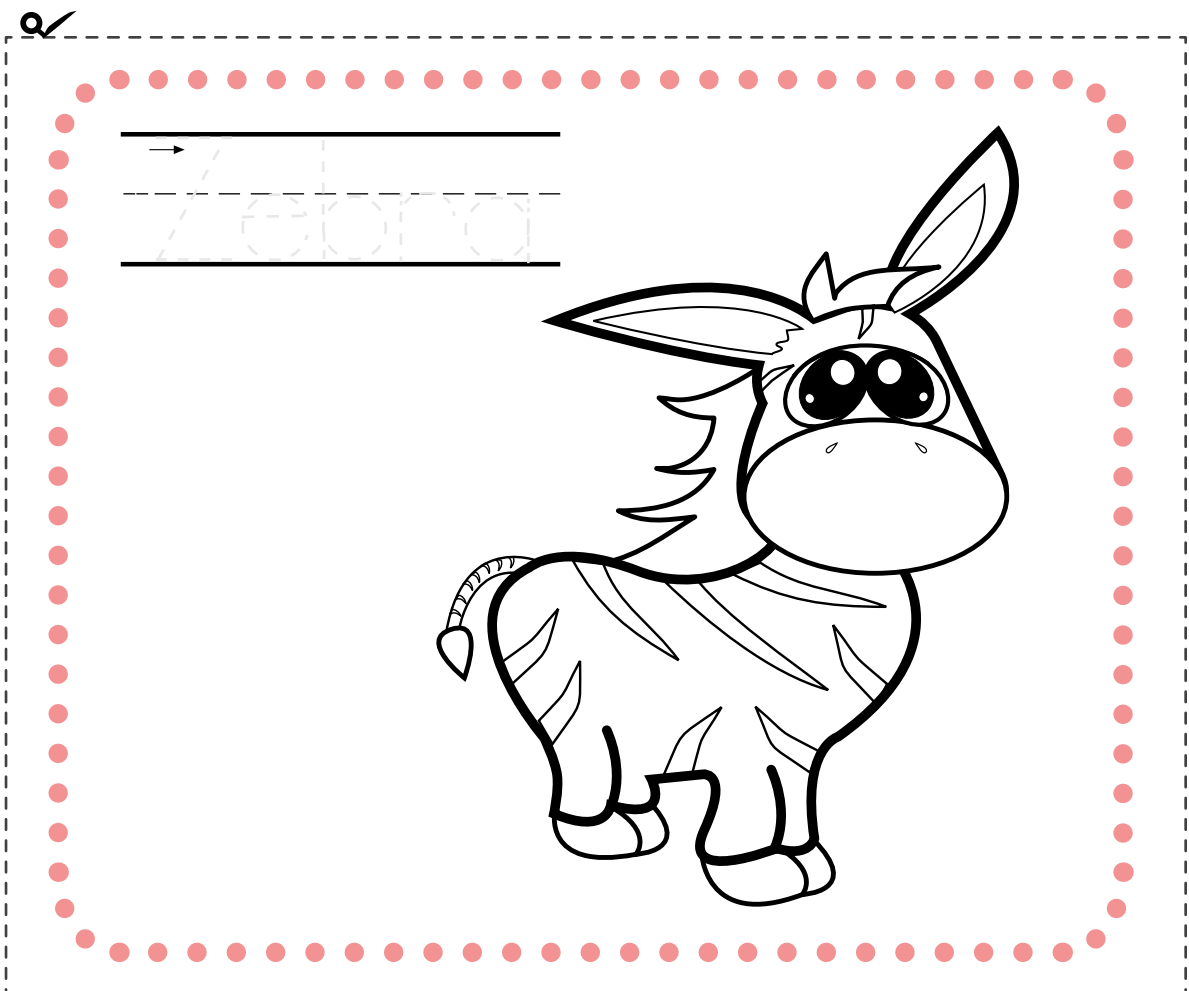
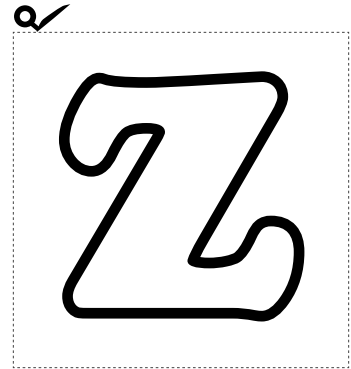
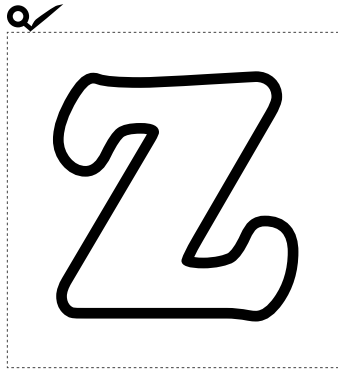
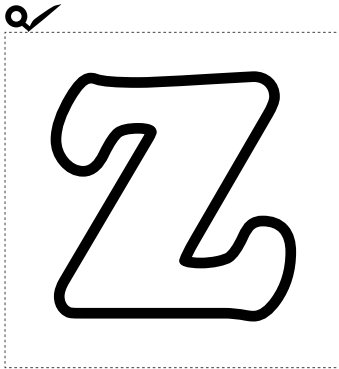



Great job!

is an ThuVienTiengAnh.Com writing superstar

